



WE BUILD™
with you | 2020 FULL-LINE CATALOG
MILLERWELDS.COM

WE BUILD™

Everything. With Everyone.

We build with the aerospace welder whose work helps us travel the world — and with the artist whose work helps us smile.

We build with the pro who's welded in a factory for 30 years — and with the DIYer who's welding in their backyard for the first time.

From pipelines to project cars, from skyscrapers to sculptures, if you weld, Miller welds with you. Together, **WE BUILD™**.

About the front cover

Hope Struse

is the winner of our 2018 Build Welding's Future promotion. Nominated by her former welding instructor, Hope is an award-winning welder who is now a welding instructor herself. She shares her knowledge with students at Cochise College in Sierra Vista, Arizona.

Dick Keeney

runs the welding and machine shop that his father, Kelly, founded. For more than 60 years and through three generations, welding has supported the Keeney family — and has served citizens in and around Miles, Iowa (population 438), with quality metalwork.

Coleton Fisher

is a welding fabricator at Metal Connection LLC in Oshkosh, Wisconsin. After spending his teen years exploring every technical class at his school, Coleton has found welding fabrication to be an ideal career — one in which every day brings a new challenge.



For pricing or to find your local distributor, visit us on the web or give us a call.

MillerWelds.com     

1-800-4-A-Miller (1-800-426-4553)



New from Blue

Shop with speed and convenience

Visit MillerWelds.com for a fast and easy way to buy welding products for your home or shop.

Shop with expert advice and attention

Visit your local Miller distributor for in-depth knowledge and one-on-one assistance in product selection.

MillerWelds.com/wheretobuy



11 XR-AlumaFeed® SuitCase®



12 Deltaweld® 500 and IntellX™ Dual-Wire Feeders



40 Maxstar® 280 Multiprocess



57 Syncrowave® 300



73 Bobcat™ 200 Air Pak™ Diesel



105/107 LPR-100™ OV Half Mask Respirator and New Welding Helmet Graphics



Benefits of Blue

Technologies and innovations

Miller is committed to bringing forward-thinking technologies and solutions to the welding industry. We listen to your challenges and constantly seek to improve our products and services to better address them.



Ease of use

ArcConnect™

Next generation communication that utilizes high-speed signals to improve weld performance and allow point-of-use controls to be located at the feeder. Found on the Deltaweld® Systems (pg 12).



Allows for any input voltage hookup with no manual linking. Provides convenience in any job setting and is ideal for dirty or unreliable power. Found on the following products:

MIG

Millermatic® 255 (pg 9)
AlumaPower™ 350 (pg 11)
Invision™ 352 (pg 14)
Continuum™ (pg 15)
Auto-Continuum™ (pg 16)

Multiprocess

Multimatic® 255 (pg 39)
Maxstar® (pg 40)
Dynasty® (pg 40)
XMT® 350 (pg 42–45)

Stick

Maxstar® (pg 48–49)

TIG

Maxstar® (pg 52/54–56)
Syncrowave® 210 (pg 53)
Dynasty® (pg 54–56)

Plasma cutters

Spectrum® (pg 90–91)

Auto-Set™

Provides speed, convenience and confidence of preset controls and eliminates guesswork when setting weld parameters. Variations of this technology include **Advanced Auto-Set** and **Auto-Set Elite**. Found on the following products:

MIG

Millermatic® 141/211/
212 Auto-Set™/255 (pg 7–9)

Multiprocess

Multimatic® (pg 37–39)

TIG

Syncrowave® 210 (pg 53)

ClearLight™

Lens Technology

Optimizes contrast and clarity in welding and light states. 1/1/1/2 optical clarity rating allows a lighter light state while not welding, providing versatility for varied applications. Found on T94™, Digital Infinity™, Digital Elite™ and Digital Performance™ welding helmets (pg 106–107).

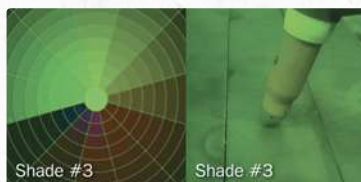
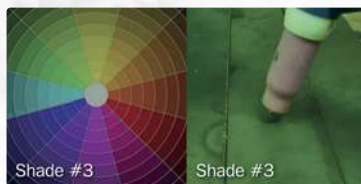

MVP™ plugs and adapters

Allows connection to common 120- or 240-volt receptacles without the use of tools — just choose the plug/adaptor that fits the receptacle. Found on the following products:



MIG

Millermatic® 211 (pg 7)

Multiprocess

Multimatic® 200/215/220 AC/DC (pg 37–38)

Stick

Thunderbolt® 160 (pg 48)

TIG

Diversion™ (pg 52)
Syncrowave® 210 (pg 53)

Engine drives

Fusion (pg 71)

Plasma cutters

Spectrum® 375/625 (pg 90–91)



Provides single-phase stick weld capability with the engine shut off by plugging into 120- or 240-volt wall power. Ideal for indoor or noise-sensitive environments. Found on the Fusion engine drive (pg 71).

Pro-Set™

Provides speed, convenience and confidence of preset controls and eliminates guesswork when setting TIG weld parameters. Found on the following products:

Multiprocess

Multimatic® 220 AC/DC (pg 38)
Maxstar® (pg 40)
Dynasty® (pg 40)

TIG

Syncrowave® (pg 53, 57)
Maxstar® (except 161) (pg 54–56)
Dynasty® (pg 54–56)

QuickTech™

Provides easy setup and process changing on the Multimatic® 220 AC/DC multiprocess welder (pg 38).

- *Automatically* determines polarity. Work is always connected to the bottom right receptacle. MIG gun and TIG torch can stay connected at the same time.
- *Automatically* switches to the right process. Just hit trigger or foot control and the machine automatically changes, eliminating the need to manually change processes.
- *Automatically* recalls settings from the last process used.

X-Mode™

Electromagnetically senses the weld to eliminate sunlight interference and continuously detects the arc even if sensors are blocked. Found on T94™, Digital Infinity™, Digital Elite™ and Classic VSi™ welding helmets (pg 106–107).

Productivity

ArcReach® ArcReach technology allows operators to adjust welding parameters right at the weld joint without a control cord, using the wire feeder (pg 18/46) or remote (pg 46) — maximizing arc-on time and impacting the bottom line. Found on the following products:

Multiprocess

Dimension™ 650 ArcReach (pg 41)
XMT® 350 FieldPro™ models (pg 44)
XMT® 450 CC/CV ArcReach (pg 45)

Engine drives

Trailblazer® 325 ArcReach models (pg 76)
Big Blue® ArcReach models (pg 78–81)

Auto-Speed™

Automatically adjusts engine speed to meet demands so the engine never works harder than necessary. Reduces fuel consumption, exhaust emissions and noise levels on the Bobcat™ 200 Air Pak™ (pg 73) and Trailblazer® 325 (pg 76) engine drives.

Excel™ power

Provides 2,400 watts (20 A) of 120-volt power at all engine speeds, including idle. Reduces fuel consumption, exhaust emissions and noise levels on select models of the Trailblazer® 325 engine drive (pg 76).

Optimization and performance

Advanced welding processes

Versa-Pulse™ is a fast, low-heat, low-spatter process designed for materials up to 1/4 inch and is great for gap filling.

Accu-Pulse® is better for out-of-position welds, provides higher deposition rates and has the most adaptive arc on 16 gauge and thicker materials.

RMD® (Regulated Metal Deposition) is a modified-short-circuit welding process with the lowest heat process and limited travel speed. It is designed to fill gaps in thin-material applications and provides a higher quality root pass, calm stable arc and less spatter.

Advanced welding processes are found on the following products:

MIG

Deltaweld® 350/500 with Intelx™ Pro feeder (Accu-Pulse only) (pg 12)
Continuum™ Systems (pg 15)
Auto-Continuum™ Systems (pg 16)

Multiprocess (RMD only)

XMT® 350 FieldPro models (pg 44)*
PipeWorx 400 Welding System (pg 47)

Engine drives (RMD only)

Trailblazer® 325 ArcReach models (pg 76)*
Big Blue® ArcReach models (pg 78–81)*

*Requires an ArcReach Smart Feeder.

Augmented reality welding

Builds a larger, more skilled welding workforce and quickly helps correct errors, reinforces proper welding practices and accelerates skill advancement. This training solution is found on the AugmentedArc™ augmented reality welding system (pg 113).



InfoTrack™

Data monitoring technology tracks arc time and features a clock. Version 2.0 adds arc count. Found on T94™ and Digital Infinity™ welding helmets (pg 106–107).

Fan-On-Demand™

Fan only operates when needed to reduce noise, energy use and amount of contaminants pulled through the machine. Found on various MIG, multiprocess, stick, TIG and plasma cutter products.

ZoneFlow™ technology

Extended-capture weld fume extraction technology extends the capture zone up to five feet deep and four feet wide (versus up to 18 inches from conventional source capture extractors). The increased capture zone reduces arm interactions so operators can keep welding, increasing arc-on time and productivity. Found on FILTAIR® Capture 5, and select FILTAIR® SWX and 4000–12000 models (pg 100–102).



DYNAMIC DIG Automatically adjusts the amount of current required to clear a short. Delivers a smoother, more consistent arc that can be tailored to match the application, material, fit-up and welder technique. Found on Trailblazer® 325 (pg 76) and Big Blue® (pg 78–81) engine drives.

Insight Welding Intelligence™

Insight Core™ is a simplified, internet-based welding information solution that reports operator productivity and deposition, as well as weld parameter verification.

Insight Centerpoint™ is an advanced PC-based operator feedback solution designed to detect missed welds, verify proper weld sequence and provide weld defect detection — all in real time.

Insight ArcAgent™ is a set of premium data acquisition tools that enable both Insight Core and Insight Centerpoint solutions to integrate with any brand of welding power source.

For more information on Insight Welding Intelligence, see pages 67–69. Insight Welding Intelligence is found on the following products:

MIG (Core is standard and Centerpoint is optional)
Continuum™ (pg 15)
Auto-Continuum™ (pg 16)

Note: Insight Core is compatible with many 14-pin compliant Miller® power sources (see list at MillerWelds.com/insight) using an Insight Core 14-pin module or ALL power sources using an ArcAgent for Insight Core. Insight Centerpoint is compatible with ALL power sources using an ArcAgent Manual or ArcAgent Auto.



Product Guide

	Page	Class	MIG	Pulsed MIG	Flux-cored*	CAC-A	Portability	Weldable Metals	Welding Output Range	Special Features	Typical Applications
1-Phase	Millermatic® 141	7	●	●	●		Handles, optional running gear	Steel, stainless, aluminum	30-140 A	All-in-one, 120 V input, Auto-Set™ Smooth-Start™	Up to 3/16 in. using self-shielded wire maintenance/repair, auto body, hobby
	Millermatic® 211	7	●	●	●				30-230 A	All-in-one, 120 or 240 V input, Auto-Set™ Smooth-Start™	Up to 3/8 in. maintenance/repair, auto body, hobby
	Millermatic® 212 Auto-Set™	8	●	●	●		Installed running gear	Steel, stainless, aluminum	30-210 A	All-in-one, 230 V input, Fan-On-Demand™ Gun-On-Demand™	Up to 3/8 in. fabrication, farm, garage/body shops
	Millermatic® 252	8	●	●	●				30-300 A	All-in-one, standard timers menu, Fan-On-Demand™ connects to standard MIG gun, push-pull gun or spool gun	Up to 1/2 in. industrial production/fabrication, farm
	Millermatic® 255	9	●	●	●		Handles, optional running gear	Steel, stainless, aluminum	20-350 A	All-in-one, Auto-Set™ stores up to 4 programs, connects to standard MIG gun, push-pull gun or spool gun	Up to 1/2 in. industrial production/fabrication, pulsed MIG ideal for thin gauge aluminum
1- and 3-Phase	Millermatic® 350P	10	●	●	●		Installed running gear	Steel, stainless, aluminum	25-400 A	All-in-one, connects to standard MIG gun, push-pull gun or spool gun	Up to 1/2 in. industrial production/fabrication, pulsed MIG ideal for thin gauge aluminum
	Millermatic® 350P Aluminum	10	●	●	●			Aluminum	25-400 A	All-in-one, optimized for feeding aluminum wire only using a push-pull gun or spool gun	Up to 1/2 in. industrial aluminum production/fab, pulsed MIG ideal for thin gauge aluminum
	AlumaFeed™ 350 Aluminum System	11	●	●	●		Handles, optional cart, MIGRunner™	Aluminum	5-425 A 10-38 V	Profile Pulse™ lightweight feeder can be up to 100 feet from power source	Heavy industrial aluminum production/fabrication, truck trailer, shipbuilding
	Invision™ 352 MPa Plus System	14	●	●	●	1/4"		Most metals	5-425 A 10-38 V	Push-pull gun capability, optimized with 74 MPa Plus wire feeder	Manufacturing and production
3-Phase	AlumaFeed™ 450 Aluminum System	11	●	●	●		Handles, optional cart, MIGRunner™	Aluminum	15-600 A 10-38 V	Profile Pulse™ lightweight feeder can be up to 100 feet from power source	Heavy industrial aluminum production/fabrication, truck trailer, shipbuilding
	Invision™ 450 MPa Plus System	14	●	●	●	5/16"		Most metals	15-600 A 10-38 V	Push-pull gun capability, optimized with 74 MPa Plus wire feeder	Manufacturing and production
	Deltaweld™ 350 Systems	12	●	●	●		Lift eye, optional running gear, MIGRunner™	Steel, stainless	20-400 A 10-38 V	Special arc control feature when paired with Intelx™ feeders, Accu-Pulse® MIG welding with Intelx Pro feeders	Medium-to-large manufacturing and fabrication
	Deltaweld™ 500 Systems	12	●	●	●	3/8"			30-650 A 10-44 V	Special arc control feature when paired with Intelx™ feeders, Accu-Pulse® MIG welding with Intelx Pro feeders	Medium-to-large manufacturing and fabrication
	Continuum™ 350	15	●	●	●	1/4"	Lift eye, optional running gear, MIGRunner™	Most metals	20-400 A 10-44 V	Advanced arc performance, Welding Intelligence™	Mid- to high-volume manufacturing
	Continuum™ 500	15	●	●	●	3/8"			20-600 A 10-44 V	Advanced arc performance, Welding Intelligence™	Mid- to high-volume manufacturing
	Auto-Continuum™ 350	16	●	●	●		Lift eye	Steel, stainless	20-400 A 10-44 V	Available for EtherNet/IP™, DeviceNet and analog protocol	Fixed and flexible automation
	Auto-Continuum™ 500	16	●	●	●				20-600 A 10-44 V	Available for EtherNet/IP™, DeviceNet and analog protocol	Fixed and flexible automation

Product Key

Class: ● Light industrial ● Industrial ● Heavy industrial Capability: ● Designed for this process ● Capable of this process
 New! or Improved! products appear in blue type. *If using self-shielded wire on a CC/CV machine, use CV weld output.

Millermatic® 141 and 211

See literature DC/12.42 (141) and DC/12.58 (211)

Light industrial **CV DC 1** Phase

Processes

- MIG (GMAW) ▪ Flux-cored (FCAW)

Comes complete with

- 10 ft. (3 m) 100-amp MDX™-100 MIG gun
- 10 ft. (3 m) work cable with clamp
- 6.5 ft. (2 m) power cord with plug (Millermatic 141) **OR** 6.5 ft. (2 m) power cord with MVP plugs for 120 V and 240 V (Millermatic 211)
- Quick Select™ drive roll for .024 in. (0.6 mm) or .030/.035 in. (0.8/0.9 mm) solid wire, and .030/.035 in. (0.8/0.9 mm) flux-cored wire



- Flow gauge regulator and gas hose for argon or AR/CO₂ mix, two .030 in. contact tips, Hobart® spool of .030 in. solid wire, hook-and-loop cord wraps and material thickness gauge (229895)

Most popular accessories

- Spoolmate™ 100 300371 (pg 27)
- Spoolmate™ 150 301272 (pg 27) (for Millermatic 211 only)



- Running Gear/Cylinder Rack 301239 (pg 114)
- Protective Cover 301262 (pg 117)
- V-Knurled Drive Roll 202926

Visit MillerWelds.com or your distributor for other Miller® options and accessories.



Millermatic 211



Multi-voltage plug (MVP™) allows connection to common 120- and 240-volt power receptacles without the use of any tools – simply choose the plug that fits the receptacle and connect to the power cord.

Millermatic 141



Mild Steel Welding Capability

	3/16 in. (4.8 mm)	3/8 in. (9.5 mm)
Max. Model	141	211
Min.	24 ga. (0.6 mm)	24 ga. (0.6 mm)

Aluminum Welding Capability

	14 ga. (1.9 mm)	3/8 in. (9.5 mm)
Max. Model	141	211
Min.	18 ga. (1.2 mm)	18 ga. (1.2 mm)

Aluminum welding with the Millermatic 141 uses optional Spoolmate 100 spool gun and 4043 series aluminum wire. Aluminum welding with the Millermatic 211 uses optional Spoolmate 100 spool gun with 4043 aluminum series wire **OR** optional Spoolmate 150 spool gun with 4000 or 5000 series aluminum wire.

Recommended aluminum solution

Spoolmate 100 (page 27) with both Millermatic models **OR** Spoolmate 150 (page 27) with Millermatic 211.



Auto-Set™ automatically provides the right settings to weld mild steel while **infinite voltage control** allows the flexibility to manually set your own parameters. Millermatic 211 model provides additional capabilities.



- Set the wire diameter (141: .024/.030 in.) (211: .024/.030/.035 in.), a blue light shows Auto-Set is activated
- Dial in the thickness of material you are welding
- Start welding with the exact parameters you need!

Angled cast-aluminum drive system with calibrated tension knob creates consistent feeding and easy setup.

Quick Select™ drive roll makes setup quicker by offering three grooves – two for different size solid wire and a third for flux-cored wire.

Auto Spool Gun Detect™ automatically detects when a MIG gun or spool gun is connected, eliminating the need for a switch.

Smooth-Start™ provides a smooth, spatter-free start.

Thermal overload protection shuts down unit and activates the **over temperature light** if airflow is blocked or duty cycle is exceeded. Automatically resets when unit cools.

Uses 4- or 8-inch (102 or 203 mm) spools.

Millermatic 211 model additional features

Advanced Auto-Set™ includes five different wire/gas combinations and .024-, .030- and .035-inch wire capabilities.

Inverter technology combines best-in-class arc characteristics with the portability of a 38-pound machine. The arc is extremely forgiving to variations in arc length and travel speeds.

Fan-On-Demand™ cooling system only operates when needed, reducing power consumption and keeping internal components cleaner.

Model/Stock Number	Input Power	Amperage Range	Rated Output	Amps Input at Rated Output, 50/60 Hz		Wire Feed Speed	Wire Type and Diameter Capacity	Power Source Dimensions	Power Source Net Weight		
				120 V	240 V	KVA	KW				
Millermatic 141 (907612) (951601) with running gear/cylinder rack	120 V	30-140	90 A at 18.5 VDC, 20% duty cycle	20	–	3.0	2.45	15-360 ipm (0.4-9.1 m/min.)	Solid steel .023-.030 in. (0.6-0.8 mm) Stainless .023-.030 in. (0.6-0.8 mm) Flux-cored .030-.035 in. (0.8-0.9 mm)	H: 12.5 in. (318 mm) W: 11.25 in. (286 mm)	51 lb. (23.1 kg)
	120 V	30-130	115 A at 19.8 VDC, 20% duty cycle	24.3	–	2.9	2.9	60-600 ipm (1.5-15.2 m/min.)	Solid steel .023-.035 in. (0.6-0.9 mm) Stainless .023-.035 in. (0.6-0.9 mm) Flux-cored .030-.045 in. (0.8-1.2 mm)	D: 20.5 in. (521 mm)	38 lb. (17.2 kg)
Millermatic 211 (907614) (951603) with running gear/cylinder rack	240 V	30-230	150 A at 21.5 VDC, 40% duty cycle	–	16.6	4.0	4.0				

Millermatic® 212 Auto-Set™

See literature DC/12.46



Recommended aluminum solution
Spoolmate 200 (page 27).

Welding Capability

Max. 3/8 in. (9.5 mm)	Max. 3/8 in. (9.5 mm)
Mild Steel	Aluminum
Min. 22 ga. (0.8 mm)	Min. 14 ga. (1.9 mm)

Aluminum welding uses optional Spoolmate 200 spool gun.

Auto-Set™ makes setup quick and easy. On the Millermatic 212, it works with .030- and .035-inch wire (see page 7 for more information).

Infinite voltage control. When used in manual mode provides broader operating range with finer control than a tap machine.

Gun-On-Demand™. Simply pull the trigger for either gun and you're ready to weld. No wasted time installing modules and using gas valve kits.

Heavy-duty aluminum two-drive-roll system.

Fan-On-Demand™ cooling system only operates when needed, reducing power consumption and keeping internal components cleaner.

Aluminum MIG welding with optional Spoolmate™ 200 spool gun. Wire feed speed control on the gun saves time by reducing trips back to the machine. Also compatible with the more industrial Spoolmatic® spool guns.

Light industrial ● **CV DC 1**
Phase

Processes

■ MIG (GMAW) ■ Flux-cored (FCAW)

Comes complete with

- 15 ft. (4.5 m), 250-amp MDX™-250 MIG gun
- 10 ft. (3 m) work cable with clamp
- 7 ft. (2.1 m) power cord with plug
- Flow gauge regulator and gas hose for argon or AR/CO₂ mix
- Factory-installed lowered running gear/cylinder rack
- .030/.035 in. reversible dual-groove drive rolls
- Extra contact tips and material thickness gauge (229895)

Most popular accessories

- Spoolmate™ 200 300497 (pg 27)
- Dual EZ-Change™ Low Cylinder Rack 300337 (pg 114)
- Elevated Gun and Cable Rack 300335 (pg 114)
- Protective Cover 195142 (pg 117)
- Full KVA Adapter Cord 300517 (pg 118)
- 230-Volt Extension Cord 770644

Visit MillerWelds.com or your distributor for other Miller® options and accessories.

Stock Number	Amperage Range	Rated Output	Amps Input at Rated Output, 60 Hz				Wire Feed Speed	Wire Type and Diameter Capacity	Dimensions	Net Weight
			200 V	230 V	KVA	KW				
(907405) 200(208)/230 V (951177) 200(208)/230 V with Spoolmate 200, regulator, and dual cylinder rack	30-210	160 A at 24.5 VDC, 60% duty cycle	31	28	6.2	5.2	50-700 ipm (1.3-17.8 m/min.)	Solid steel .023-.035 in. (0.6-0.9 mm) Stainless .023-.035 in. (0.6-0.9 mm) Flux-cored .030-.045 in. (0.8-1.2 mm)	H: 30 in. (762 mm) W: 19 in. (483 mm) D: 40 in. (1,016 mm)	183 lb. (83 kg)

Millermatic® 252

See literature DC/12.49



Recommended aluminum solution
Spoolmatic 15A OR 30A (page 28).

Welding Capability

Max. 1/2 in. (13 mm)	Max. 3/8 in. (9.5 mm)
Mild Steel	Aluminum
Min. 22 ga. (0.8 mm)	Min. 14 ga. (1.9 mm)

Aluminum welding uses optional Spoolmatic 15A OR 30A spool gun.

Infinite voltage control with self-calibrating digital meters that permit presetting of voltage and wire feed speed. Ensures precise parameters and accuracy.

EXCLUSIVE! Auto-Gun Detect™ automatically adjusts voltage, wire speed and timers for faster switching between MIG, push-pull and spool guns.

Integrated digital timers come complete with presettable preflow/postflow, bumback, spot and delay (stitch) timers. Independent timers for MIG and spool gun.

Heavy-duty aluminum two-drive-roll system.

Fan-On-Demand™ cooling system only operates when needed, reducing power consumption and keeping internal components cleaner.

Superior aluminum MIG welding with direct connection of optional Spoolmate™ 200 and Spoolmatic®/Spoolmatic Pro spool guns or XR™ push-pull guns. No extra module to buy or install.

Industrial ● **CV DC 1**
Phase

Processes

■ MIG (GMAW) ■ Flux-cored (FCAW)

Comes complete with

- 15 ft. (4.5 m), 250-amp MDX™-250 MIG gun
- 10 ft. (3 m) work cable with clamp
- 10 ft. (3 m) industrial power cord (and plug on 200/230 V model)
- Factory-installed gas solenoid
- Flow gauge regulator and gas hose for argon or AR/CO₂ mix
- Factory-installed lowered running gear/cylinder rack
- .030/.035 in. reversible dual-groove drive rolls
- Extra contact tips

Most popular accessories

- Spoolmate™ 200 and Spoolmatic® Spool Guns (pg 27-28)
- XR™ Air-Cooled Push-Pull Guns (pg 29)
- Dual EZ-Change™ Low Cylinder Rack 300337 (pg 114)
- Elevated Gun and Cable Rack 300335 (pg 114)
- Protective Cover 195142 (pg 117)
- 230-Volt Extension Cord 770644

Visit MillerWelds.com or your distributor for other Miller® options and accessories.

Stock Number	Amperage Range	Rated Output	Amps Input at Rated Output, 60 Hz						Wire Feed Speed	Wire Type and Diameter Capacity	Dimensions	Net Weight
			200 V	230 V	460 V	575 V	KVA	KW				
(907321) 200(208)/230 V (951066*) 200(208)/230 V	30-300	200 A at 28 VDC, 60% duty cycle	48	42	—	—	9.5	7.5	50-700 ipm (1.3-17.8 m/min.)	Solid steel .023-.045 in. (0.6-1.2 mm) Stainless .023-.045 in. (0.6-1.2 mm) Flux-cored .030-.045 in. (0.8-1.2 mm)	H: 30 in. (762 mm) W: 19 in. (483 mm) D: 40 in. (1,016 mm)	205 lb. (94 kg)
(907322) 230/460/575 V (951065*) 230/460/575 V		250 A at 28 VDC, 40% duty cycle	—	46	23	18	9.5	7.5				

*With Spoolmatic 30A, regulator and dual cylinder rack.

Millermatic® 255

See literature DC/12.8



Millermatic 255 with running gear package shown.

Welding Capability

Max. 1/2 in. (13 mm)	Max. 1/2 in. (13 mm)
Mild Steel	Aluminum
Min. 24 ga. (0.6 mm)	Min. 18 ga. (1.2 mm)

Aluminum welding uses optional XR-Aluma-Pro push-pull gun.

Recommended aluminum solution

XR-Aluma-Pro™ push-pull gun (page 29).



Easy-to-understand interface with 7-inch color LCD display ensures proper machine setup and parameter selection, reducing setup time and increasing weld time.

- Quick-access Auto-Set and pulse mode backlit buttons across the top illuminate when active
- Soft-key buttons below the display change function depending on which screen is displayed – makes setup or change quick, easy and intuitive
- Large text for easier readability
- Intuitive connection setup images
- Full troubleshooting descriptions versus help errors and look up codes

AUTO-LINE TECHNOLOGY Allows for any input voltage hookup (208–240 V, single-phase) with no manual linking, providing convenience in any job setting. Ideal solution for dirty or unreliable power.

Auto-Set™ Elite offers predefined weld settings to increase ease of use and ensure that the job is done right for operators of all skill levels.

- Available for MIG and pulsed MIG processes with the ability to fine-tune your settings
- Set weld parameters by selecting wire and gas type, wire diameter and material thickness

Built-in pulsed MIG programs. All programmed information is restored after each power up – aluminum/steel/stainless steel.

Program mode allows easy save and recall of favorite weld settings. Delivers more productivity and consistent quality while minimizing supervisor intervention.

EXCLUSIVE! Auto-Gun Detect™ automatically adjusts voltage, wire speed and timers for faster switching between MIG, push-pull and spool guns.

Heavy-duty aluminum two-drive-roll system.

Fan-On-Demand™ cooling system only operates when needed, reducing power consumption and keeping internal components cleaner.

Industrial **CV DC 1** Phase

Processes

- MIG (GMAW) ▪ Flux-cored (FCAW)
- Pulsed MIG (GMAW-P)

Millermatic 255 comes complete with

- 15 ft. (4.5 m) 250-amp MDX™-250 MIG gun with Bernard® AccuLock™ S consumables
- 10 ft. (3 m) work cable with clamp
- 10 ft. (3 m) industrial power cord
- Factory-installed gas solenoid
- Flow gauge regulator and gas hose for argon or AR/CO₂ mix
- Chain to secure gas cylinder
- .035/.045 in. reversible V-groove drive rolls
- Extra contact tips and material thickness gauge (229895)

Most popular accessories

- MDX™-250 EZ-Select™ MIG Gun 1770047 (pg 24)
- Spoolmatic® Spool Gun (pg 28) (non-Pro gun only)
- XR-Aluma-Pro™ Air-Cooled Push-Pull Guns (pg 29)
- EZ-Latch™ Single Cylinder Running Gear 301449 (pg 114)
- EZ-Latch™ Dual Cylinder Rack with Elevated Gun and Cable Rack 301481

Converts an EZ-Latch™ Single Cylinder Running Gear into a Dual Cylinder Rack Running Gear as seen below



- **EZ-Latch™ Dual Cylinder Rack Running Gear** 951769 (pg 114)
- Protective Cover 301521 (pg 117)

Visit MillerWelds.com or your distributor for other Miller® options and accessories.

Stock Number (907734) 208-240 V (951766) 208-240 V with single cylinder running gear	Amperage Range	Rated Output	Amps Input at Rated Output, 50/60 Hz				Wire Feed Speed	Wire Type and Diameter Capacity	Power Source Dimensions	Power Source Net Weight
			208 V	240 V	KVA	KW				
	20-350	230 A at 25.5 V, 60% duty cycle	44.0	39.5	9.5	7.2	50-800 ipm (1.3-20 m/min.)	Solid steel .023-.045 in. (0.6-1.2 mm) Stainless .023-.045 in. (0.6-1.2 mm) Aluminum .035-.047 in. (0.9-1.2 mm) Flux-cored .030-.045 in. (0.8-1.2 mm)	H: 19.24 in. (489 mm) W: 13.75 in. (349 mm) D: 26.25 in. (667 mm)	84 lb. (38 kg)

Millermatic® 350P

See literature DC/12.51



Recommended aluminum solution
XR-Aluma-Pro™ push-pull gun (page 29).

Welding Capability

Max. 1/2 in. (13 mm)	Max. 1/2 in. (13 mm)
Mild Steel	Aluminum
Min. 24 ga. (0.6 mm)	Min. 18 ga. (1.2 mm)

Aluminum welding uses optional XR-Aluma-Pro push-pull gun.

Built-in pulsed MIG programs. All programmed information is restored after each power up – aluminum/steel/stainless steel/metal-cored.

Infinite voltage control with self-calibrating digital meters that permit presetting of voltage and wire feed speed. Ensures precise parameters and accuracy.

EXCLUSIVE! Auto-Gun Detect™ automatically adjusts voltage, wire speed and timers for faster switching between MIG, push-pull and spool guns.

Integrated digital timers come complete with presettable preflow/postflow and spot timers. Independent timers for MIG and push-pull guns.

Heavy-duty aluminum four-drive-roll system.

Fan-On-Demand™ cooling system only operates when needed, reducing power consumption and keeping internal components cleaner.

Industrial ● **CV DC 3 1**
Phase Phase

Processes

- MIG (GMAW) = Flux-cored (FCAW)
- Pulsed MIG (GMAW-P)

Comes complete with

- 15 ft. (4.5 m) Bernard® BTB Gun 300 A with Centerfire™ consumables
- 10 ft. (3 m) work cable with clamp
- 10 ft. (3 m) industrial power cord (without plug) for single- or three-phase
- Factory-installed gas solenoid
- Flow gauge regulator and gas hose for argon or AR/CO₂ mix
- Factory-installed, low-mounted running gear/cylinder rack
- .035/.045 in. reversible V-groove drive rolls (order U-groove drive rolls for aluminum welding)
- Extra contact tips

Most popular accessories

- Spoolmatic® Spool Gun (pg 28) (non-Pro gun only)
- XR™ Air-Cooled Push-Pull Guns (pg 29)
- Dual Cylinder Rack 195299 (pg 114)
- Protective Cover 195142 (pg 117)
- 230-Volt Extension Cord 770644

Visit MillerWelds.com or your distributor for other Miller® options and accessories.

Stock Number (907300) 200/230/460 V	Input Power	Amperage Range	Rated Output	Amps Input at Rated Output, 60 Hz					Wire Feed Speed	Wire Type and Diameter Capacity	Dimensions	Net Weight
	Three-phase			200 V	230 V	460 V	KVA	KW				
	Single-phase		300 A at 32 VDC, 60% duty cycle	34	30	15	11.6	11.5	Optional spool gun/push-pull gun 50-800 ipm (1.3-20 m/min.)		H: 34 in. (863 mm) W: 19 in. (483 mm) D: 41 in. (1,041 mm)	181 lb. (82 kg)

Millermatic® 350P Aluminum

See literature DC/12.56



Millermatic 350P Aluminum with XR-Aluma-Pro™ Lite gun shown.

Welding Capability

Max. 1/2 in. (13 mm)
Aluminum
Min. 18 ga. (1.2 mm)

Aluminum welding uses optional XR-Aluma-Pro push-pull gun. Not compatible with standard MIG gun.

True torque feed motor push-pull design provides continuous push force to the wire while the gun motor controls the speed at the gun. The motors work together to provide accurate and positive wire feed speed without wire shaving or deformation.

Electronic wire spool brake allows wire spool to free spool while welding, resulting in smooth wire delivery.

Built-in aluminum pulsed MIG programs for simplicity and improved puddle control. Pulsed welding virtually eliminates burn-through and warping issues on thinner materials.

Synergic MIG and synergic pulsed MIG provide communication between power source, feeder and gun. As wire speed increases/decreases, the pulse or MIG parameters also increase/decrease to match the right amount of power needed.

Trigger schedule select allows operator to change between two sets of weld parameters.

Trigger hold reduces operator fatigue on extended welds.

Industrial ● **CV DC 3 1**
Phase Phase

Processes

- Aluminum MIG (GMAW)
- Aluminum pulsed MIG (GMAW-P)

Comes complete with

- 10 ft. (3 m) work cable with clamp
- 10 ft. (3 m) industrial power cord (without plug) for single- or three-phase
- Factory-installed gas solenoid
- Flow gauge regulator and gas hose for argon
- Factory-installed, low-mounted running gear/cylinder rack
- .035 and .047 in. (0.9 and 1.2 mm) U-groove drive rolls for aluminum welding

Push-pull gun systems include above plus

- XR™ air-cooled push-pull gun (see choices far left in chart below)

Most popular accessories

- XR™ Air-Cooled Push-Pull Guns (pg 29)
- Dual Cylinder Rack 195299 (pg 114)
- Protective Cover 195142 (pg 117)
- 230-Volt Extension Cord 770644

Visit MillerWelds.com or your distributor for other Miller® options and accessories.

Stock Number Millermatic 350P Aluminum Push-Pull Gun System (951451) w/15 ft. XR-Aluma-Pro™ air-cooled gun (951452) w/25 ft. XR-Aluma-Pro™ air-cooled gun (951453) w/25 ft. XR™-Pistol Pro air-cooled gun (951454) w/25 ft. XR-Aluma-Pro™ Lite air-cooled gun Millermatic 350P Aluminum (gun NOT included) (907474) 200/230/460 V standard unit	Input Power	Amperage Range	Rated Output	Amps Input at Rated Output, 60 Hz					Wire Feed Speed	Wire Type and Diameter Capacity	Dimensions	Net Weight
	Three-phase			200 V	230 V	460 V	KVA	KW				
	Single-phase		300 A at 32 VDC, 60% duty cycle	34	30	15	11.6	11.5			H: 34 in. (863 mm) W: 19 in. (483 mm) D: 41 in. (1,041 mm)	181 lb. (82 kg)

AlumaFeed[®] Synergic Aluminum Welding System

See literature DC/34.0

Dedicated aluminum system for the most advanced MIG and synergic pulsed MIG performance.

NEW! Impact-resistant and flame-retardant suitcase-style feeder.



AlumaPower™ 350 MPa and XR-AlumaFeed® SuitCase® with XR-Aluma-Pro gun air-cooled package shown.

AUTO-LINE TECHNOLOGY AlumaPower™ 350 model allows for any input voltage hookup (208–575 V, single- or three-phase) with no manual linking, providing convenience in any job setting. Ideal solution for dirty or unreliable power. 450 model is 230/460 V manual link or 575 V, three-phase only.

Synchronized, true push-pull wire feed system for precise wire feeding and arc performance.

Profile Pulse™ provides TIG appearance with MIG simplicity and productivity. Achieve “stacked dimes” without gun manipulation. Profile Pulse frequency can be changed to increase or decrease the spacing between the ripple pattern to achieve the desired weld appearance.



Synergic pulsed MIG. As wire speed increases/decreases, pulse parameters also increase/decrease to match the right amount of power needed, eliminating the need to make additional adjustments.

Built-in MIG and pulsed MIG programs automatically set the optimal parameters for a wide variety of wires making it easy to set up and use.

Parameter and system locks enhance quality assurance and protect weld consistency.

Trigger schedule select allows operator to change between two sets of weld parameters.

Heavy industrial  **CV DC 3 1** AlumaPower 450 is 3-phase only.
Phase Phase

Processes

- Aluminum MIG (GMAW)
- Aluminum pulsed MIG (GMAW-P)

Most popular accessories

- XR™ Push-Pull Guns (pg 29)
- MIGRunner™ Cart 195445 (pg 115)
- Coolmate™ 3 043007 (pg 115)
- Coolant 043810 (pg 115)
- Industrial MIG 4/0 Kits (pg 117)
 - 300405 With Dinse connectors (350 MPa only)
 - 300390 With lug connectors (450 MPa only)
- Consists of flowmeter regulator with 10 ft. (3 m) gas hose, 10 ft. (3 m) 4/0 feeder weld cable, and 15 ft. (4.6 m) work cable with 600-amp C-clamp
- Extension Cables (pg 122)
 - 247831025 25 ft. (7.6 m)
 - 247831050 50 ft. (15 m)
 - 247831080 80 ft. (24.4 m)
- 1/16-Inch (1.6 mm) Liner and Wire Kit for Gun 230708
- 1/16-Inch (1.6 mm) Drive Roll Kit for Control Box 195591
- For gun and feeder remote options, see literature DC/34.0 or visit MillerWelds.com

Visit MillerWelds.com or your distributor for other Miller® options and accessories.



Models/Packages

*Additional packages are available – visit MillerWelds.com or your distributor.



Power Source Only Stock Number	Package Stock Number*	XR-AlumaFeed SuitCase Feeder	XR-Aluma-Pro™ Push-Pull MIG Gun	XR™-Pistol Grip Push-Pull MIG Gun	Industrial MIG 4/0 Kit	Coolmate™ with Coolant	Cart
AlumaPower 350 MPa (907420) 208–575 V (907420001) 208–575 V with auxiliary power	(951834) w/350 model (907420)	(301567)	25 ft. air-cooled	–	–	–	–
	(951836) w/350 model (907420)	(301567)	–	30 ft. air-cooled	–	–	–
	(951833) w/350 model (907420)	(301567)	25 ft. air-cooled	–	With Dinse connectors	–	MIGRunner cart
AlumaPower 450 MPa (907483) 230/460 V w/auxiliary power (907484) 575 V w/auxiliary power	(951840) w/450 model (907483)	(301567)	25 ft. air-cooled	–	With lug connectors	–	MIGRunner cart
	(951839) w/450 model (907483)	(301567)	25 ft. water-cooled	–	With lug connectors	Coolmate 3	MIGRunner cart

Note: All packages listed include gun drive rolls, feeder drive rolls and consumables for .035- and 3/64-inch (0.9 and 1.2 mm) wire. All systems come set up out of the box to run 3/64-inch wire. 1/16-inch consumables not included – order separately above.

Model	Input Power	Amp/Volt Ranges	Rated Output	Amps Input at Rated Load Output, 60 Hz					KVA	KW	Max. Open-Circuit Voltage	Dimensions	Net Weight
				208 V	230 V	400 V	460 V	575 V					
AlumaPower 350 MPa	Three-phase	5–425 A 10–38 V	350 A at 34 VDC, 60% duty cycle	40.4	36.1	20.6	17.8	14.1	14.2	13.6	75 VDC	H: 17 in. (432 mm) W: 12.5 in. (318 mm) D: 24 in. (610 mm)	80 lb. (36.3 kg)
	Single-phase	5–425 A 10–38 V	300 A at 32 VDC, 60% duty cycle	60.8	54.6	29.7	24.5	19.9	11.7	11.2			
AlumaPower 450 MPa	Three-phase	15–600 A 10–38 V	450 A at 36.5 VDC, 100% duty cycle	–	49.4	–	27.2	23.6	21.6 (23.5 on 575 V)	18.3	90 VDC	H: 17.25 in. (438 mm) W: 14.5 in. (368 mm) D: 27.125 in. (689 mm)	122 lb. (55.3 kg)
XR-AlumaFeed SuitCase Feeder	Input Power	Input Welding Circuit Rating	Wire Feed Speed	Wire Diameter Capacity					Maximum Spool Size Capacity	Dimensions	Net Weight		
	24 VAC, 5 A, 50/60 Hz	400 A at 100% duty cycle System duty cycle is limited to gun rating	50–900 ipm (1.3–23 m/min.)	.035–1/16 in. (0.9–1.6 mm) Requires wire kit (230708) for gun and drive roll kit (268850) for control box to run 1/16 in. (1.6 mm) wire					12 in. (305 mm)	H: 15.5 in. (394 mm) W: 9 in. (229 mm) D: 21 in. (533 mm)	31 lb. (14.1 kg)		

Deltaweld® Systems See literature DC/16.5

The new standard in manufacturing provides the solution for welders of all skill levels, plus pulsed MIG capabilities with Intelx™ Pro integrated packages.



Deltaweld 350 System
MIGRunner with single-wire
Intelx Pro feeder shown.

Reduce the time and hassle of setting up welding systems. Make your move to a weld-ready Deltaweld MIGRunner™.

Ships as a complete package.

Just hook up your primary power, add gas, wire and welding gun, and you're ready to weld.

Versatile MIGRunner cart keeps you organized with its dual cylinder rack, MIG gun holders and spacious storage compartment beneath the power source, and portable with its lockable front casters and oversized rear wheels.

Old Deltaweld® System



Time spent assembling old Deltaweld package

New Deltaweld® System



Time spent assembling new Deltaweld package



Quality-engineered cable management protects your connections to keep you productive.



Single-wire feeder swivels for convenience and function, eliminating wear on gun and liner assembly. It moves with the MIG gun, allowing operator to see the front of the feeder and which parameters are selected.

Model <i>Most Popular MIGRunner</i> ◀	Single-Wire Intelx Feeder MIGRunner	Single-Wire Intelx Pro Feeder MIGRunner	Dual-Wire Intelx Feeder MIGRunner	Dual-Wire Intelx Pro Feeder MIGRunner
Deltaweld 350 208/230/460 V	(951792)	(951777) ◀	(951817)	(951818)
Deltaweld 500 208/230/460 V	(951814)	(951808) ◀	(951819)	(951820)
Deltaweld 500 575 V	—	(951824)	—	—

Deltaweld® Power Sources

Two power source choices

- **Deltaweld 350** has auxiliary power standard and optional 14-pin receptacle and meters for use with legacy feeders.
- **NEW! Deltaweld 500** has auxiliary power and meters standard and an optional 14-pin receptacle. It adds more power (500 amps at 100 percent duty cycle) and a dedicated gouge mode for up to 3/8-inch carbons.

ArcConnect™ is a next generation communication that utilizes high-speed signals to improve weld performance and allow point-of-use controls to be located at the feeder.

Wind Tunnel Technology™ Internal air flow that protects components, greatly improving reliability.

Fan-On-Demand™ cooling system only operates when needed, reducing power consumption and keeping internal components cleaner.



Deltaweld 350

Deltaweld 500

Intellex™ Wire Feeders



Intellex single-wire feeder Intellex Pro single-wire feeder Intellex and Intellex Pro dual-wire feeders

Feeders include a Bernard® BTB Gun 300 A (two with dual-wire models) with .035/.045 in. drive rolls and Centerfire™ contact tips.



Dedicated wire feeder options

- **Intellex™ feeders** with new arc control feature means welders can produce better welds with minimal parameter adjustments.
- **Intellex™ Pro feeders** add Accu-Pulse®, EZ-Set, steel weld programs, and memory buttons. Accu-Pulse® provides a 28 percent wider operating window and a more forgiving arc, while EZ-Set simplifies parameter setup based on material thickness, removing complexity.

NEW! Dual-wire models allow two different wire types to be available on one feeder, avoiding downtime from changing spools and drive rolls.

User-friendly interface makes the system easy to set up and adjust with minimal training.

Rotatable drive assembly allows operator to rotate the drive, eliminating severe bends in the wire feed path. This extends gun-liner life and aids in feeding difficult wires.

Balanced-pressure drive-roll design and tensioners feed wire in its truest and straightest form for consistent feedability and better welding performance.

Intellex Feeder Features

Feature	Intellex	Intellex Pro
Digital meters	●	●
Remote voltage	●	●
Wire feed speed	●	●
Arc control	●	●
Trigger hold	●	●
Wire jog and purge	●	●
Wire feed speed feedback	●	●
Four drive rolls	●	●
Rotatable drive	●	●
Up to 60 lb. spool	●	●
MIG process	●	●
Dual-wire models	●	●
EZ-Set MIG		●
EZ-Set Accu-Pulse®		●
Trigger select		●
Preflow		●
Postflow		●
Memory slots (2)		●
Out-of-box programs (steel only)		●

NEW! Intellex™ Pro Swingarc™

Models include control cable, Bernard® BTB Gun 400 A (two with dual-wire models) with Centerfire™ contact tips, and .035/.045 in. drive rolls.

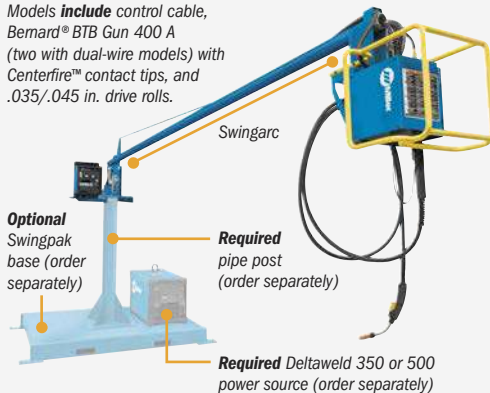

Single- and dual-wire models with 12- or 16-foot booms are sized to accommodate a variety of weld cell layouts (24- or 32-foot diameter work area).

Counterbalance design makes it easy to position boom and **360-degree rotation and 60-degree lift angle** maximize work area.

In-boom cable routing organizes hoses and cables for a cleaner work environment.

Model	Single-Wire Intellex Pro Swingarc	Dual-Wire Intellex Pro Swingarc
12 ft. (3.7 m) Boom	(951804)	(951805)
16 ft. (4.9 m) Boom	(951806)	—

*Refer to Deltaweld 500 owner's manual for gouge mode ratings and KVA/KW for 575 V models.

Heavy industrial ● CV DC 3 Phase

Processes

- MIG (GMAW) ▪ Flux-cored (FCAW)
- Accu-Pulse® MIG (GMAW-P) with Intellex Pro feeder
- Air carbon arc gouging (CAC-A) with Deltaweld 500

MIGRunner™ packages include

- Deltaweld power source 350: 907747 500: 907785 or 907786
- Intellex **OR** Intellex Pro single-wire or dual-wire feeder
- Bernard® BTB Gun(s) (350: 300 A **OR** 500: 400 A) and .035/.045 in. V-groove drive rolls
- Factory-installed Deltaweld running gear with cable holder, gun holders, and chains for gas cylinders
- Cart accessory kit consisting of flowmeter regulator(s) with 5 ft. (1.5 m) gas hose(s), 10 ft. (3 m) 4/0 feeder weld cable with lugs, 15 ft. (4.6 m) work cable with 600-amp C-clamp, and 9 ft. (2.7 m) ArcConnect cable
- Quick-setup guide and video

Most popular accessories

- Bernard® MIG Guns (pg 25–26)
- Deltaweld 350/500 Running Gear 301523 (pg 115)
- Industrial MIG 4/0 Kits with lugs (stationary packages only) (pg 117)
- ArcConnect Control/Motor Cables 280471009 9 ft. (2.7 m) 280471015 15 ft. (4.6 m) 280471025 25 ft. (7.6 m) 280471050 50 ft. (15.2 m) 280471075 75 ft. (22.9 m) 280471100 100 ft. (30.5 m)
- Cart Accessory Kit 301528 (see above for contents)
Note: For dual-wire feeder kit both 301528 and 301579 are required.
- Feeder Swivel Kit 301533 Mounts single- or dual-wire feeder to Deltaweld – only single feeder swivels
- Stationary Handle Kit 301529
- Hanging Bail 058435
- Pipe Post with 18 in. Base 149838 4 ft. 149839 6 ft.
- Swingpak™ Base 183997
- Single/Dual Spool Carrier 300353 For 4 ft. post 300352 For 6 ft. post
See page 22 for more information

Visit MillerWelds.com or your distributor for other Miller® options and accessories.

350 A	Power Source Only/Stock Number Most Popular Models ◀	Amp/Volt Ranges	Rated Output*	Amps Input at Rated Load Output, 60 Hz*						Power Source Dimensions (Includes lift eye)	Power Source Net Weight
	Deltaweld 350 (907747) ◀ 208/230/460 V (907747001) 208/230/460 V with 14-pin and meters	20–400 A 10–38 V	300 A at 29 VDC, 100% duty cycle 350 A at 31.5 VDC, 60% duty cycle 425 A at 35.25 VDC, 30% duty cycle	208 V	230 V	460 V	575 V	KVA	KW	H: 22.36 in. (568 mm) W: 15.35 in. (390 mm) D: 29.15 in. (740 mm)	115 lb. (52.2 kg)
500 A	Deltaweld 500 (907785) ◀ 208/230/460 V with meters (907785001) 208/230/460 V with 14-pin and meters (907786) 575 V with meters (907786001) 575 V with 14-pin and meters	30–650 A 10–44 V	500 A at 39 VDC, 100% duty cycle 575 A at 42.75 VDC, 60% duty cycle 650 A at 44 VDC, 25% duty cycle	64.2	58.1	30.4	24.8	24.2	21.7	H: 22.36 in. (568 mm) W: 15.35 in. (390 mm) D: 31.65 in. (804 mm)	145 lb. (65.8 kg)
				80.2	73.5	38.0	30.4	30.3	27.2		
					94.2	84.9	43.9	34.9	35.0	31.6	

Feeder Only/Stock Number	Input Power	Input Welding Circuit Rating	Wire Feed Speed	Wire Diameter Capacity	Maximum Spool Size Capacity	Dimensions (H x W x D)	Net Weight
Intellex (951783) Single-wire Intellex Pro (951784) ◀ Single-wire Intellex (951815) Dual-wire Intellex Pro (951816) Dual-wire	50 VDC	600 A at 113 VDC, 60% duty cycle	50–780 ipm (1.3–19.8 m/min.)	.023–5/64 in. (0.6–2.0 mm)	18 in. (457 mm), 60 lb. (27 kg)	Single: 16.25 x 12.38 x 27.88 in. (413 x 314 x 708 mm) Dual: 14 x 18 x 34.5 in. (356 x 457 x 876 mm)	Single: 44.8 lb. (20.3 kg) Dual: 77 lb. (34.9 kg)

Invision™ MPa Plus Systems

See literature DC/23.6

MIG and synergic pulsed MIG system with optimized weld programs for both steel and aluminum.



Invision 352 MPa

Invision 450 MPa



Recommended Aluminum Solution

Dedicated XR Plus guns work with MPa Plus feeders. See page 21 for information and stock numbers.

Auto-Line™ Invision 352 allows for any input voltage hookup (208–575 V, single- or three-phase) with no manual linking. 450 model is 230/460 V manual link or 575 V, three-phase only.

Profile Pulse™ provides TIG appearance with MIG simplicity and productivity. Achieve “stacked dimes” without gun manipulation. Profile Pulse frequency can be changed to increase or decrease spacing between the ripple pattern.



Synergic pulsed MIG when using a 70 Series MPa Plus feeder. As wire speed increases/decreases, pulse parameters also increase/decrease to match the right amount of power needed, eliminating the need to make additional adjustments.

Built-in MIG and pulsed MIG programs automatically set the optimal parameters for a wide variety of wires making it easy to set up and use.

Heavy Industrial ●
 Invision 450
 is 3-phase only.

Processes

- MIG (GMAW) ▪ Flux-cored (FCAW)
- Pulsed MIG (GMAW-P)
- Air carbon arc gouging (CAC-A)

Most popular accessories

- 70 Series MPa Plus feeders (pg 20)
- XR-Aluma-Pro™ Plus and XR™-Pistol Plus push-pull guns (pg 21)
- 70 Series Swingarc™ with MPa Plus control box (pg 22)
- Bernard® MIG Guns (pg 25–26)
- MIGRunner™ Cart (pg 115)
- Running Gear Cylinder Rack (pg 115)
- Industrial MIG 4/0 Kits (pg 117)
- Extension Cables (pg 122)

Visit MillerWelds.com or your distributor for other Miller® options and accessories.

Model	Power Source Only Stock Number	Package Stock Number*	70 Series MPa Plus Feeder with .035/.045 in. Drive Rolls and Bernard BTB 400 A Gun	XR-Aluma-Pro™ Plus Push-Pull MIG Gun	Industrial MIG 4/0 Kit	Cart
Invision 352 MPa	(907431) 208–575 V	Alum (951844) w/model 907431	D-74 dual-wire feeder with two push-only MIG guns	25 ft. air-cooled	Dinse connectors	Running gear cylinder rack
	(907431001) 208–575 V w/aux power		(951411) w/model 907431	S-74 single-wire feeder with one push-only MIG gun	–	Dinse connectors
Invision 450 MPa	(907485) 230/460 V w/aux power	Steel (951499) w/model 907485	S-74 single-wire feeder with one push-only MIG gun	–	Lug connectors	MIGRunner cart
	(907486) 575 V w/aux power		(951457) w/model 907485	D-74 dual-wire feeder with two push-only MIG guns	–	Lug connectors

*Additional packages are available — visit MillerWelds.com or your distributor.

Model	Input Power	Amp/Volt Ranges	Rated Output	Amps Input at Rated Load Output, 60 Hz					KVA	KW	Max. Open-Circuit Voltage	Dimensions	Net Weight
				208 V	230 V	400 V	460 V	575 V					
Invision 352 MPa	Three-phase	5–425 A, 10–38 V	350 A at 34 VDC, 60% duty cycle	40.4	36.1	20.6	17.8	14.1	14.2	13.6	75 VDC	H: 17 in. (432 mm) W: 12.5 in. (318 mm) D: 24 in. (610 mm)	80 lb. (36.3 kg)
	Single-phase	5–425 A, 10–38 V	300 A at 32 VDC, 60% duty cycle	60.8	54.6	29.7	24.5	19.9	11.7	11.2			
Invision 450 MPa	Three-phase	15–600 A, 10–38 V	450 A at 36.5 VDC, 100% duty cycle	–	49.4	–	27.2	23.6	21.6 (23.5 on 575 V)	18.3	90 VDC	H: 17.25 in. (438 mm) W: 14.5 in. (368 mm) D: 27.125 in. (689 mm)	122 lb. (55.3 kg)

Miller recommends



Hobart® aluminum filler metals — wire and cut lengths — have been designed to provide the best performance for the best welds. These products are backed by the deep industry knowledge of Hobart welding specialists who can help customers find the right aluminum filler metal solution. Every time. No matter how challenging the application.

Visit HobartBrothers.com or your local distributor to learn more.

Questions? Hobart is here to help.

Continuum™ Systems

See literature DC/36.0

Next generation of advanced industrial welding solutions improves productivity through weld quality, ease of use and system flexibility.



Continuum 350 push-only MIGRunner package shown (motor cable not pictured).

More power — better reliability

Up to 26 percent more welding output (than competitive models) for demanding industrial applications.

AUTO-LINE TECHNOLOGY Allows for any input voltage hookup (230–575 V, three-phase) with no manual linking, providing convenience in any job setting. Ideal solution for dirty or unreliable power.

Power source design

Smart and powerful digital design

has the fast response needed to deliver the most stable welding performance for better welding results.

Flexible to meet current and future needs with integrated expansion capabilities.

Welding Intelligence™ Increase productivity, improve quality and manage costs with Insight Core™ (standard) and Insight Centerpoint™ (optional) welding information management systems (see pages 68 and 69).

Feeder design

Tru-Feed™ technology provides precise feeding operation for stable arc performance.

- **Low-inertia motor** provides faster response for the best arc starts with the least amount of spatter.
- **Balanced-pressure drive-roll design and tensioners** feed wire in its truest and straightest form for consistent feedability, resulting in better welding performance.

User-friendly interface makes the system easy to set up and adjust with minimal training.

Heavy industrial 

Processes

- Accu-Pulse® MIG (GMAW-P)
- Versa-Pulse™ ▪ RMD® ▪ MIG (GMAW)
- High-deposition MIG (GMAW)
- Flux-cored (FCAW)
- Air carbon arc gouging (CAC-A)

MIGRunner™ packages include

- Continuum power source
- **Push-only pkg:** Continuum single-wire feeder with Bernard® BTB Gun 400 A and .035/.045 in. V-groove drive rolls
- **Push-pull pkg:** Continuum dual-wire feeder with XR-Aluma-Pro Plus gun and .035/.047 in. U-groove drive rolls, and Bernard® BTB Gun 400 A and .035/.045 in. V-groove drive rolls
- Continuum running gear/cylinder rack and handles/cable hangers
- 3 ft. (0.9 m) control/motor cable
- Industrial MIG 4/0 kit consisting of flowmeter regulator(s) with 10 ft. (3 m) gas hose(s), 10 ft. (3 m) 4/0 feeder weld cable with lugs, and 15 ft. (4.6 m) work cable with 600-amp C-clamp

Wire feeding options

- Continuum Feeders* (see chart below)
- Continuum Swingarc™ Boom-Mounted Feeders*
 - 951635 12 ft. (3.7 m) single-wire
 - 951636 16 ft. (4.9 m) single-wire
 - 951725 12 ft. (3.7 m) dual-wire

*Feeders include a Bernard BTB Gun 400 A (two with dual-wire models) and .035/.045 in. V-groove drive rolls.

- See literature DC/36.0 for additional booms and options

Most popular accessories

- Bernard® MIG Guns (pg 25–26)
- Insight Centerpoint™ Software (pg 69)
- Continuum Running Gear/Cylinder Rack 301264 (pg 115)
- Industrial MIG 4/0 Kits (with lug connectors) (pg 117)
- Continuum Integrated Cooler 301214 Mounts to bottom of power source — does not require external power
- Continuum Control/Motor Cables
 - 263368003 3 ft. (0.9 m)
 - 263368015 15 ft. (4.6 m)
 - 263368025 25 ft. (7.6 m)
 - 263368050 50 ft. (15 m)
 - 263368080 80 ft. (24.4 m)
 - 263368100 100 ft. (30.5 m)

Visit MillerWelds.com or your distributor for other Miller® options and accessories.

Continuum Processes

Best For	Standard Spray	High-Deposition MIG	Accu-Pulse	Versa-Pulse	Short Circuit	RMD
Deposition	A	A	A	B	D	D
Gap Filling	D	D	B	B	A	A
Low Heat Input	D	C	B	A	A	A
Out-of-Position Welds			A	B	B	B
Low Spatter	A	A	A	B	C	B
Thick Metals	A	A	A	C	D	D
Thin Metals			B	A	A	A
Increased Travel Speed	A	A	A	A	B	C

HOT  COLD

Ratings A, B, C, and D are relative values. An “A” rating indicates a best fit between your performance needs and process.

A “blank” rating indicates that the process is not recommended for that application.

Accu-Pulse is the most popular process for majority of industrial welding applications.

Versa-Pulse is a fast, low-heat, low-spatter process designed for thin-material applications.

RMD is a low-heat, modified short-circuit process designed to fill gaps with thin-material applications.

High-deposition MIG provides increased deposition rates over standard spray on thicker materials.

*While idling.

Model	Stock Number	Amp/Volt Ranges	Rated Output	Amps Input at Rated Output, 50/60 Hz, 3-Phase						Max. Open-Circuit Voltage	Power Source Dimensions (Includes lift eye)	Power Source Net Weight	
				230 V	380 V	400 V	460 V	575 V	KVA	KW			
Continuum 350	(951671) 230–575 V push-only MIGRunner package (951781) 230–575 V push-pull MIGRunner package (907636) 230–575 V power source only (907636001) 230–575 V with running gear/cylinder rack	20–400 A 10–44 V	350 A at 31.5 VDC, 100% duty cycle	36.7	21.8	20.8	18.8	14.6	14.4	13.8	72 VDC	H: 27.187 in. (691 mm) W: 17.5 in. (444 mm) D: 28.125 in. (714 mm)	127 lb. (57.6 kg)
Continuum 500	(951672) 230–575 V push-only MIGRunner package (951782) 230–575 V push-pull MIGRunner package (907640) 230–575 V power source only (907640001) 230–575 V with running gear/cylinder rack	20–600 A 10–44 V	500 A at 39 VDC, 100% duty cycle	57.6	34.7	33.2	28.9	23.3	23.1	21.9	72 VDC		148 lb. (67.1 kg)

Model/Stock Number	Input Power	Input Welding Circuit Rating	Wire Feed Speed	Wire Diameter Capacity	Maximum Spool Size Capacity	Dimensions	Net Weight
Continuum Feeder (951631) Single-wire model (951673) Dual-wire model	50 VDC	500 A at 100% duty cycle	Standard: 50–1,000 ipm (1.3–25.4 m/min.)	.035–5/64 in. (0.9–2.0 mm)	18 in. (457 mm), 60 lb. (27 kg)	H: 13.812 in. (351 mm) Single W: 16.312 in. (414 mm) Dual W: 17 in. (432 mm) D: 29.687 in. (754 mm)	Single: 43 lb. (19.5 kg) Dual: 61.5 lb. (27.9 kg)

Auto-Continuum™ Systems

See literature AU/10.0

Next generation automation welding solution delivers advanced arc performance to improve throughput and weld quality.



Auto-Continuum 500 shown with robot arm (not included) and Auto-Continuum wire drive motor assembly.



Close-up of Auto-Continuum wire drive motor assembly (left-hand drive).

More power – better reliability. Up to 26 percent more welding output (than competitive models) for demanding industrial applications.

AUTO-LINE TECHNOLOGY Allows for any input voltage hookup (230–575 V, three-phase) with no manual linking, providing convenience in any job setting. Ideal solution for dirty or unreliable power.

Improve work environment and reduce spatter. Versa-Pulse and Accu-Pulse processes reduce fume generation, and by precisely controlling the welding arc they also reduce spatter size and quantity. Fume generation can be reduced up to 50 percent over traditional CV MIG.

- **Versa-Pulse** is a fast, low-heat, low-spatter process for high-speed automation on thin materials and is great for gap filling.
- **Accu-Pulse** is better for out-of-position welds, provides higher deposition rates and is designed for thicker materials than Versa-Pulse.

Easy communication from robot to power source.

Designed for easy integration with fixed and flexible automation.

Fleet standardization. Auto-Continuum can be used for both automation and hand-held applications.

Welding Intelligence™ Increase productivity, improve quality and manage costs.

- **Insight Core™** (standard) is a simplified, internet-based welding information solution that reports cell productivity and weld parameter verification (see page 68).
- **Insight Centerpoint™** (optional) is an advanced, real-time feedback solution to ensure consistent weld quality and actively detects a bad weld when it happens, reducing rework costs and improving quality (see page 69).

Heavy Industrial ● **CV DC 3** Phase

Processes

- Accu-Pulse® MIG (GMAW-P)
- Versa-Pulse™ ▪ RMD® ▪ MIG (GMAW)
- High-deposition MIG (GMAW)
- Flux-cored (FCAW)

Most popular accessories

- Insight Centerpoint™ Software (pg 69)
- Auto-Continuum Robotic MIG Kit 301455
Consists of 25 ft. (7.6 m) motor control cable, 15 ft. (4.6 m) 90-degree motor control extension cable, 15 ft. (4.6 m) weld cable, flowmeter regulator, 30 ft. (9.1 m) gas hose, 16.4 ft. (5 m) Ethernet cable, .035/.045-inch V-groove drive roll kit with guides, 30 ft. (9.1 m) weld wire conduit assembly, and 10 ft. (3 m) conduit and clamps (for mounting motor control cable, weld cable and gas hose)
- Wire Drive Motor Mounting Brackets
301276 ABB® 1600
301277 ABB® 2600
300483 FANUC® 100 and 120 IC
300013 FANUC®/KUKA®/Motoman®
300375 Motoman® EA1400
300376 Motoman® EA1900
- Motor Control Cables
263368025 25 ft. (7.6 m)
263368050 50 ft. (15 m)
263368080 80 ft. (24.4 m)
263368100 100 ft. (30.5 m)
- 90-degree Motor Control Extension Cables
281554015 15 ft. (4.6 m)
281554025 25 ft. (7.6 m)
- EtherNet/IP™ Communication Cables
300734 9.8 ft. (3 m)
300736 32.8 ft. (10 m)
- DeviceNet Communication Cable
300021 20 ft. (6.1 m)

Visit MillerWelds.com or your distributor for other Miller® options and accessories.

*While idling.

Model/Stock Number	Amp/Volt Ranges	Rated Output	Amps Input at Rated Output, 50/60 Hz, 3-Phase							Max. Open-Circuit Voltage	Dimensions (Includes lift eye)	Net Weight
			230 V	380 V	400 V	460 V	575 V	KVA	KW			
Auto-Continuum 350 (907656) 230–575 V (907658) 230–575 V with auxiliary power	20–400 A 10–44 V	350 A at 31.5 VDC, 100% duty cycle	36.7 0-1*	21.8 0-1*	20.8 0-1*	18.8 0-1*	14.6 0-1*	14.4 0.8*	13.8 0.17*	72 VDC	H: 27.187 in. (691 mm) W: 17.5 in. (444 mm) D: 28.22 in. (717 mm)	130 lb. (59.4 kg)
Auto-Continuum 500 (907657) 230–575 V (907659) 230–575 V with auxiliary power	20–600 A 10–44 V	500 A at 39 VDC, 100% duty cycle	57.6 0-1*	34.7 0-1*	33.2 0-1*	28.9 0-1*	23.3 0-1*	23.1 0.8*	21.9 0.17*	72 VDC		150 lb. (69 kg)
Model/Stock Number	Input Power	Input Welding Circuit Rating	Wire Feed Speed		Wire Diameter Capacity		Dimensions		Net Weight			
Auto-Continuum Wire Drive Motor Assembly (301207) Left-hand drive (301208) Right-hand drive	50 VDC	500 A at 100% duty cycle	Standard: 50–1,000 ipm (1.3–25.4 m/min.)		.035–5/64 in. (0.9–2.0 mm)		H: 8.75 in. (222 mm) W: 10 in. (254 mm) D: 10 in. (254 mm)		16.5 lb. (7.5 kg)			



For more detailed information, visit

MillerWelds.com/wirefeeders

Wire Feeders

Also see MIG, MIG Guns and Multiprocess sections for wire feeding options.



Product Guide

	Page	Class	MIG	Pulsed MIG ¹	RMD ²	Flux-cored ²	Power Source Required	Wire Types				Wire Diameter Capacity	Special Features	Typical Applications	
								Hard	Flux-cored Dual-shld	Self-shld	Alum.				
ArcReach® SuitCase® (8 and 12)	18	●	●	●		●	CC/CV	●	●	● CV ²	●	.023-5/64 in. (0.6-2.0 mm)	8 in. (SuitCase 8) or 12 in. (SuitCase 12) diameter spool capacity, remote voltage control without a control cord, powered by arc voltage	Construction, site fabrication, field maintenance	Portable
ArcReach® Smart Feeder	18	●	●	●		●	ArcReach equipped	●	●			.035-.045 in. (0.9-1.1 mm)	12 in. diameter spool capacity, remote voltage control without a control cord, requires an XMT 350 FieldPro connected to three-phase power or an ArcReach-equipped engine drive	Process piping, refinery, petrochemical, power plants, HVAC, water pipe	
SuitCase® 12RC	18	●	●	●		●	CV	●	●	●	●	.023-5/64 in. (0.6-2.0 mm)	12 in. diameter spool capacity, standard remote voltage control, powered by 14-pin control cord	Field maintenance, site fabrication	
20 Series (Basic and Digital)	20	●	●	●		●	CV	●	●	●	●	.023-5/64 in. (0.6-2.0 mm)	Four quick-change drive rolls, digital meters, remote voltage control (meters and remote voltage control are a field kit option on basic model)	Manufacturing, fabrication	Bench
70 Series (74S and 74D) Singles and Duals	20	●	●	●		●	CV	●	●	●	●	.023-5/64 in. (0.6-2.0 mm)	Four quick-change drive rolls, remote voltage control (field kit option on 74S models), digital meters (74D only)	Heavy and light manufacturing, fabrication	
70 Series (74 MPa Plus) Singles and Duals	20	●	●	●		●	CV	●	●	●	●	.023-5/64 in. (0.6-2.0 mm)	XR-Aluma-Pro™ Plus or XR™-Pistol Plus guns for feeding soft wires	Manufacturing requiring multiple wire types	
70 Series Swingarc™ Singles and Duals	22	●	●	●		●	CV	●	●	●	● ³	.023-5/64 in. (0.6-2.0 mm)	12 and 16 ft. booms, four drive rolls, adjustable weld control	Heavy and light manufacturing, fabrication	
70 Series Remote Configurations Singles and Duals	22	●	●	●		●	CV	●	●	●	● ³	.023-5/64 in. (0.6-2.0 mm)	Control box, cables and wire drive motor assemblies for generic booms or fixed automation	Heavy and light manufacturing, fabrication	

Product Key

Class: ● Light industrial ● Industrial ● Heavy industrial Capability: ● Designed for this process ● Capable of this process

¹ Smart Feeder requires an XMT® 350 FieldPro™ connected to three-phase power or an ArcReach-equipped engine drive. All other feeders require an MPA inverter power source.

² Certain self-shielded wires require CV output. Miller recommends a CV power source whenever possible.

³ 74S and 74D models are capable of aluminum welding. 74 MPa Plus models are designed for aluminum welding.

SuitCase® Series Portable Feeders

Portable SuitCase feeders that set the standard for performance and provide extreme reliability to stand up to the demands of construction and fabrication.

SuitCase Series Features

Feature	ArcReach			
	8	12	Smart	12RC
Available with Bernard gun:				
BTB Gun 300 A	●	●		●
S-Gun	●	●		
Dura-Flux gun	●	●		
PipeWorx gun		●	●	
Remote voltage control (control cord required)				●
Remote voltage control (without a cord)	●	●	●	
Digital meters	●	●	●	●
Impact-resistant case	●	●	●	●
Gas purge	●	●	●	●
Wire jog	●	●	●	●



Bernard BTB Gun 300 A shown.

Note: ArcReach SuitCase feeders are compatible with standard power sources and engine-driven welders, but function as standard equipment without remote control capabilities. Full functionality of ArcReach is only available with ArcReach power sources.

Feeders include a male Tweco® connector installed on weld cable and are available with a Bernard® gun and drive rolls (see chart on page 19). BTB Gun 300 A and S-Gun™ come with reversible dual size (.045 and 1/16 in. V-knurled) drive rolls. Dura-Flux™ flux-cored gun comes with reversible dual size (.068/.072 and 5/64 in. V-knurled) drive rolls. PipeWorx 300-15 gun comes with reversible dual size (.035 V-grooved and .045 in. V-knurled) drive rolls.

Setting the standard for performance

Heavy-duty drive motor with tachometer control provides wire feed speed that is accurate and consistent from the start of the weld to the finish and from one weld to the next. Consistent wire feed speed is very important with large-diameter cored wire, because small changes in wire feed speed make large changes in deposition rates.

Wide voltage range for small and large wires with no contactor chatter or arc outages.



Ultra-low drag inlet guide pins make loading the wire easy and do not deform the wire on the way into the drive rolls, improving wire feeding performance.



Scaled wire pressure knob provides easy adjustment and consistent pressure on the drive rolls and wire.



Digital meters with SunVision™ technology can display voltage, wire feed speed, and also amperage if desired. Meters can be seen clearly even in direct sunlight.

Unique and durable case

Impact-resistant, flame-retardant case provides strength and durability, while protecting components and welding wire from moisture, dust and other contaminants.

Built-in slide rails allow you to drag the feeder into position for welding.

Innovative feeder door design allows you to change wire while feeder is standing upright or laying down.

ArcReach SuitCase models are available in two sizes. SuitCase 8 model is sized for an 8-inch spool of wire, can be carried to remote welding sites, and fits through a 14-inch manhole/manway. SuitCase 12 model is sized for an 8- or 12-inch spool of wire. 12-inch spools are the most common in structural steel and fabrication.

Extreme reliability

Potted-and-trayed main printed circuit board for the harshest environments adds exceptional reliability. Board has full-trigger isolation so a shorted gun trigger will not affect feeder operation.



Gun locking tab works with guns having corresponding locking grooves to prevent gun from being pulled out if the feeder is dragged by the gun.



Gas inlet recessed into back of case is protected from incidental contact by the weld cable, ensuring consistent and contaminant-free shielding gas delivery to the gun. **Double-filtered gas valve** helps keep dirt from clogging and affecting gas flow.

ArcReach® SuitCase® 8 and 12 and ArcReach Smart Feeder

See literature M/6.55

ArcReach Remote control of the power source without a cord.

With an ArcReach SuitCase feeder and ArcReach power source you can change output voltage at the feeder, and save a trip to the power supply. No extra control cord to purchase, maintain, string or unstring – saving time and money. See pages 41, 44–45 and 76–81 for ArcReach power sources and engine drives.

Easy process changeover. Simply connect the ArcReach feeder to your leads and you are ready to go. All controls automatically shift to the ArcReach feeder.

Voltage-sensing feeders designed to run off of arc voltage. The ArcReach SuitCase 8 and 12 operate on the arc voltage of almost any power source. The ArcReach Smart Feeder requires an XMT® 350 FieldPro™ (page 44) connected to three-phase power or an ArcReach-equipped engine drive (pages 76–81).

Additional features of ArcReach Smart Feeder

Delivers excellent synergic RMD® and pulsed MIG welding up to 200 feet away from the power source with no control cords – twice the distance previously possible. RMD and pulsed MIG welding permits procedures with one wire and one gas to eliminate process switch-over time. RMD and pulsed MIG processes also help reduce weld failures and eliminate backing gas on some stainless and chrome-moly applications.



RMD carbon steel



Pulsed MIG stainless

SuitCase® 12RC See literature M/6.5

Standard remote voltage control with a control cord. For applications where the feeder is within 100 feet of the power source and control cords are acceptable.

*Additional packages are available – visit MillerWelds.com or your distributor.

Heavy industrial 

Use with CC/CV (CV only with 12RC), DC power sources. See spec chart below for Smart Feeder requirements.

Processes

- MIG (GMAW) ▪ Flux-cored (FCAW)
- RMD and pulsed MIG (GMAW-P) with ArcReach Smart Feeder

Suggested power sources

Note: ArcReach SuitCase feeders are compatible with standard power sources and engine-driven welders, but function as standard equipment without remote control capabilities. Full functionality of ArcReach is only available with ArcReach power sources.

For ArcReach SuitCase 8 and 12

- Maxstar® 280 Multiprocess (pg 40)
- Dynasty® 280 DX Multiprocess (pg 40)
- Dimension™ 650/650 ArcReach® (pg 41)
- XMT® Series (pg 42–45)
- Bobcat™ 200 Air Pak™ (pg 73)
- Bobcat™ Series (pg 74)
- Trailblazer® Series (pg 76–78)
- Big Blue® Series (pg 78–81)

For ArcReach Smart Feeder

- XMT® 350 FieldPro (pg 44) (requires three-phase power)
- Trailblazer® Series (ArcReach models only) (pg 76)
- Big Blue® Series (ArcReach models only) (pg 78–81)

For SuitCase 12RC (requires power source with 14-pin connector)

- Dimension™ 650 (pg 41)
- XMT® Series (pg 42)
- Trailblazer® Series (pg 76–78)
- Big Blue® Series (pg 78–81)

Suggested guns

- Bernard® Guns (pg 25–26)

Most popular accessories

- Extension Cables (pg 122) (for SuitCase 12RC only, 1 required)
- Flowmeter Kit 300343
- Shielding Gas Filter 195189

Visit MillerWelds.com or your distributor for other Miller® options and accessories.

	Model	Stock Number*	Input Power	Input Welding Circuit Rating	Wire Feed Speed	Wire Type and Diameter Capacity	Maximum Spool Size Capacity	Dimensions	Net Weight
ArcReach	ArcReach SuitCase 8	(951726) w/Bernard BTB Gun 300 A (951727) w/Bernard S-Gun (951728) w/Bernard Dura-Flux gun (301457) Feeder only	Operates on open-circuit voltage and arc voltage: 14–48 VDC/110 max. OCV	330 A at 60% duty cycle	50–780 ipm (1.3–19.8 m/min.) dependent on arc voltage	Solid wire .023–.052 in. (0.6–1.4 mm) Flux-cored .030–5/64 in. (0.8–2.0 mm)	8 in. (203 mm), 14 lb. (6.4 kg)	H: 12.75 in. (324 mm) W: 7.25 in. (184 mm) D: 18 in. (457 mm)	28 lb. (13 kg)
	ArcReach SuitCase 12	(951729) w/Bernard BTB Gun 300 A (951730) w/Bernard S-Gun (951731) w/Bernard Dura-Flux gun (951732) w/Bernard PipeWorx gun (301456) Feeder only		425 A at 60% duty cycle					
	ArcReach Smart Feeder	(951733) w/Bernard PipeWorx gun (300935) Feeder only	XMT 350 FieldPro connected to three-phase power or an ArcReach-equipped engine drive	275 A at 60% duty cycle	50–780 ipm (1.3–19.8 m/min.) dependent on arc voltage	.035–.045 in. (0.9–1.1 mm)	12 in. (305 mm), 33 lb. (15 kg)	H: 18 in. (457 mm) W: 13 in. (330 mm) D: 21.5 in. (546 mm)	50 lb. (23 kg)
	SuitCase 12RC	(951580) w/Bernard BTB Gun 300 A (301121) Feeder only	24 VAC, 10 A, 50/60 Hz	425 A at 60% duty cycle	50–700 ipm (1.3–17.8 m/min.)	Solid wire .023–.052 in. (0.6–1.4 mm) Flux-cored .030–5/64 in. (0.8–2.0 mm)	12 in. (305 mm), 45 lb. (20 kg)	H: 15.5 in. (394 mm) W: 9 in. (229 mm) D: 21 in. (533 mm)	31 lb. (14.1 kg)

20 Series Industrial Bench Feeders

70 Series Heavy-Industrial Bench Feeders

Designed for manufacturing, our popular bench feeders are available in two series with multiple models to fit your needs.



20 Series Digital

S-74D

S-74 MPA Plus

D-74 MPA Plus

20 and 70 Series Features

Feature	20 Series		70 Series		
	Basic	Digital	74S	74D	74MPa
Available w/Bernard gun:					
BTB Gun 300 A	●	●			
BTB Gun 400 A					●
Trigger hold	●	●	●	●	●
Digital meter(s)	●	●	●	●	●
Remote voltage control	●	●	●	●	●
Adjustable run-in control	●	●	●	●	●
Automatic run-in control			●	●	●
Dual-wire models			●	●	●
Rotatable drive assembly			●	●	●
Accu-Mate™			●	●	●
Preflow/postflow					●
Spot control					●
Dual schedule control					●
Trigger program select					●
Trigger dual schedule					●
Sequence control					●
Locks and limits					●
Weld programs					4
Trigger schedule select					●
Push-pull capability					●
Synergic pulsed MIG					●
Profile Pulse™					●

● Standard ● Field option



Bernard BTB Gun 300 A shown.

Feeders include a 10 ft. interconnecting cord and are available with a Bernard® gun and drive rolls (see chart on page 21). Feeders with BTB Gun 300 A (20 Series) or BTB Gun 400 A (70 Series, two with dual-wire models) come with Centerfire™ contact tips and .035/.045 in. drive rolls.

Trigger hold allows the operator to make long welds without having to hold the trigger continuously. Reduces operator fatigue.

Miller® standard, quick-change drive rolls save time.

Quick-release drive-roll pressure arm allows drive roll change without losing spring preload setting.

Easy loading and threading of welding wire without having to release the drive roll pressure arm.

Four gear-driven drive rolls provide more consistent feeding on larger wire diameters.

Feeders include a 10-foot 14-pin interconnecting cord and are available with a 15-foot Bernard BTB Gun 300 A (20 Series) or BTB Gun 400 A (70 Series, two with dual-wire models).

Additional features for 70 Series feeders

Available in dual-wire models which allow two different wire types to be available on one feeder, avoiding downtime from changing spools and drive rolls.

Toolless rotatable drive assembly allows operator to rotate the drive housing, allowing a straight path for wire flow.

Accu-Mate™ properly seats the MIG gun power pin for best feeding performance.

High-torque permanent-magnet motor, sealed ball bearing gear drive and solid-state speed and brake control are maintenance free for long life.

20 Series (Basic and Digital) See literature M/11.0

Simple and cost-effective feeders for industrial manufacturing and fabricating.

Ideal for most high-duty-cycle applications requiring day-in/day-out trouble-free operation.

On-board burnback and motor ramp control for excellent starting and stopping performance.

Digital meter (standard on digital model, field option on basic model) ensures accuracy when presetting and reading actual voltage, amperage and wire feed speed.

Remote voltage control (standard on digital model, field option on basic model) at feeder for easier adjustments in the weld cell.

Adjustable run-in control (standard on digital model, field option on basic model) for better arc-starting performance on a variety of wires.

70 Series (74S and 74D) See literature M/3.0

Standard, simple feeders for most heavy-industrial applications, with the 74D providing increased accuracy and control of the most common weld parameters.

Digital meters (74D models only) ensure accuracy when presetting and reading actual voltage, amperage and wire feed speed.

Remote voltage control (standard on 74D, field option on 74S) allows you to set both voltage and wire feed speed at the feeder, saving time and increasing weld quality because optimal weld parameters are easy to set.

70 Series (74 MPa Plus) See literature M/3.0

Adds features for weld control and programs, plus push-pull aluminum capabilities. Optimized with Invision™ MPa or XMT® MPa power sources.

Adjustable run-in control for improved arc starts.

Dual schedule control allows the operator to switch between two preconfigured welding parameters without readjusting the machine, saving time and enhancing quality.

Trigger schedule select saves time when switching between two weld settings by simply tapping gun trigger.

Trigger program select provides the ability to access any of the four active programs.

Sequence control gives the operator the ability to adjust all of the welding parameters: preflow, run-in, weld time, crater, burnback and postflow.

Locks and limits for restricting or limiting operator adjustments, such as voltage and wire feed speed parameters.

Four weld program memories allow operators to recall up to four previously used processes and their weld settings.

Push-pull capability provides consistent, versatile and dependable aluminum wire feeding over greater distances.

Recommended aluminum solution.

Dedicated XR Plus guns (gooseneck and pistol grip) work with MPa Plus feeders to coordinate wire feed speed of the gun and the feeder. This provides optimized aluminum feeding and welding performance. See chart below for gun models and stock numbers.



Additional features when used with Invision MPa or XMT MPa power sources

Synergic pulsed MIG. As wire speed increases/decreases, pulse parameters also increase/decrease to match the right amount of power needed, eliminating the need to make additional adjustments.

Profile Pulse™ provides TIG appearance with MIG simplicity and productivity.

Achieve “stacked dimes” without gun manipulation. Profile Pulse frequency can be changed to increase or decrease the spacing between the ripple pattern to achieve the desired weld appearance.



Industrial ● 20 Series
Heavy Industrial ● 70 Series

CVDC Use with CV, DC power sources.

Processes

- MIG (GMAW) ▪ Flux-cored (FCAW)
- Pulsed MIG (GMAW-P) with MPa Plus feeder and optional MPa power source

Suggested power sources

- Invision™ MPa Series (pg 14)
- Dimension™ 650/650 ArcReach® (pg 41)
- XMT® Series (pg 42-45)

Suggested guns

- Bernard® Guns (pg 25-26)
- XR-Aluma-Pro™ Plus and XR™-Pistol Plus (see chart below)

Most popular accessories

- Feeder Cart 142382 (pg 114)
- Extension Cables (pg 122)
- Spool Adapter 047141 (pg 122)
- Turntable Assembly 146236 (pg 122)
- Wire Straightener (pg 122)
- Field Kits for 20 Series Basic
 - 301513 Digital meter and remote voltage control
 - 301515 Run-in control
- Field Kits for 70 Series (74S)
 - 194988 Remote voltage control for single-wire models
 - 194991 Remote voltage control for dual-wire models
- Hanging Bail 058435
- Spool Covers
 - 057607 For 20 and 70 Series single-wire models and left side of dual-wire models
 - 090389 For right side of dual-wire models
- Wire Reel Assembly 108008
- Remote configurations are available – see page 22 and literature M/3.0

Visit MillerWelds.com or your distributor for other Miller® options and accessories.

*Additional packages are available – visit MillerWelds.com or your distributor. **Requires wire kit (230708) to run 1/16 in. (1.6 mm) wire.

Model	Stock Number*	Input Power	Wire Feed Speed	Wire Type and Diameter Capacity	Maximum Spool Size Capacity	Dimensions	Net Weight	
20 Series	Basic (301499) Feeder only Basic (951779) w/Bernard BTB Gun 300 A Digital (301499001) Feeder only Digital (951780) w/Bernard BTB Gun 300 A	24 VAC, 3.5 A, 50/60 Hz	75-750 ipm (1.9-19 m/min.)	.023-5/64 in. (0.6-2.0 mm)	60 lb. (27 kg) coil with optional wire reel assembly (108008)	H: 16 in. (406 mm) W: 12.375 in. (314 mm) D: 27.875 in. (708 mm)	46 lb. (21 kg)	
70 Series (Single-wire models)	S-74S (951196) w/Bernard BTB Gun 400 A S-74D (951198) w/Bernard BTB Gun 400 A S-74 MPa Plus (951291) w/Bernard BTB Gun 400 A	24 VAC, 10 A, 50/60 Hz	50-780 ipm (1.3-19.8 m/min.)	.023-5/64 in. (0.6-2.0 mm) MPa Plus model Hard wire .023-5/64 in. (0.6-2.0 mm) Aluminum** .035-1/16 in. (0.9-1.6 mm)	60 lb. (27 kg) coil with optional wire reel assembly (108008)	H: 14 in. (356 mm) W: 12.5 in. (318 mm) D: 28 in. (711 mm)	48 lb. (21.2 kg)	
70 Series (Dual-wire models)	D-74S (951203) w/Bernard BTB Gun 400 A D-74D (951204) w/Bernard BTB Gun 400 A D-74 MPa Plus (951292) w/Bernard BTB Gun 400 A					H: 14 in. (356 mm) W: 21 in. (533 mm) D: 35 in. (889 mm)	87 lb. (39.5 kg)	
Optional Push-Pull Gun (For MPa Plus feeders only)								
		Cable Length						
		15 ft. (4.6 m)	25 ft. (7.6 m)	Welding Current Rating	Wire Feed Speed	Wire Type and Diameter Capacity	Dimensions	Gun Only Net Weight
XR-Aluma-Pro Plus (Air-cooled)	(301575)	(301574)	300 A at 100% duty cycle	70-780 ipm (1.8-19.8 m/min.)	Aluminum** .030-1/16 in. (0.8-1.6 mm)	H: 5 in. (127 mm) W: 2.5 in. (64 mm) L: 17 in. (432 mm)	2.5 lb. (1.1 kg)	
XR-Aluma-Pro Plus (Water-cooled)	(301576)	(301577)	400 A at 100% duty cycle				2.9 lb. (1.3 kg)	
XR-Pistol Plus (Air-cooled)	(300753)	(300754)	200 A at 100% duty cycle	70-780 ipm (1.8-19.8 m/min.)	Aluminum** .030-1/16 in. (0.8-1.6 mm)	H: 7.375 in. (187 mm) W: 1.875 in. (48 mm) L: 10.625 in. (270 mm)	2.2 lb. (1 kg)	
XR-Pistol Plus (Water-cooled)	–	(300757)	400 A at 100% duty cycle				2.4 lb. (1.1 kg)	

70 Series Swingarc™ See literature M/13.11

Swingarc boom-mounted wire feeders bring an extra dimension of flexibility and efficiency to weld stations dealing with large weldments, or wherever operator mobility is required.

Models include a 10 ft. 14-pin interconnecting cord, Bernard® BTB Gun 400 A (two with dual-wire models) with Centerfire™ contact tips, and .035/.045 in. drive rolls.

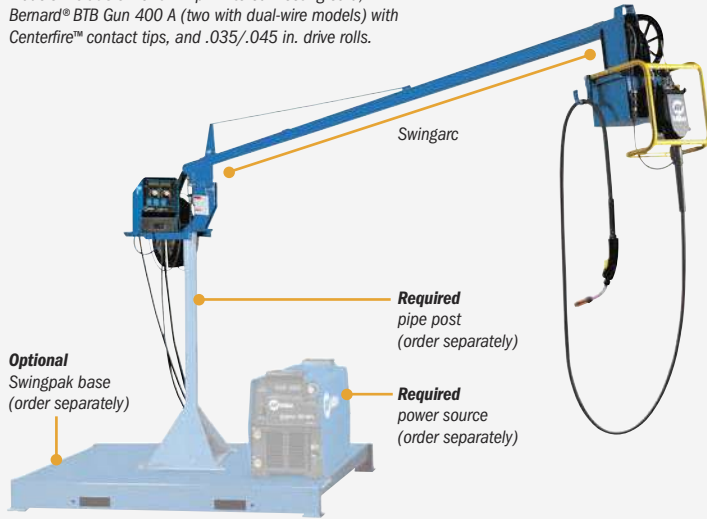

Single- and dual-wire models with 12- or 16-foot booms are sized to accommodate a variety of weld cell layouts (24- or 32-foot diameter work area).

Counterbalance design makes it easy to position boom and 360-degree rotation and 60-degree lift angle maximize work area.

In-boom cable routing organizes hoses and cables for a cleaner work environment.

MPa Plus Swingarc. Optimized for the Invision™ MPa and XMT® MPa power sources and available in single- or dual-wire models in two boom lengths.

Heavy Industrial • CV DC

Use with CV, DC power sources.

Processes

- MIG (GMAW) ▪ Flux-cored (FCAW)
- Pulsed MIG (GMAW-P) with MPa Plus control and optional MPa power source

Suggested power sources/guns

- Same as 70 Series

Most popular accessories

- Swingpak™ Base 183997
- Pipe Post with 18 in. Base 149838 4 ft. 149839 6 ft.
- Single/Dual Spool Carrier 300353 For 4 ft. post 300352 For 6 ft. post Pipe post not included – carrier is designed to put spool hub assembly at 36 inches from base for easier wire spool installation



Visit MillerWelds.com or your distributor for other Miller® options and accessories.

Model	Single-Wire Model Stock Numbers	Dual-Wire Model Stock Numbers	Input Power	Wire Feed Speed	Wire Diameter Capacity	Maximum Spool Size Capacity	Net Weight with Feeder
12 ft. (3.7 m) Boom	SS-74D12 (951526) w/S-74D SS-74 MPa Plus-12 (951438) w/S-74 MPa Plus	DS-74D12 (951535) w/D-74D DS-74 MPa Plus-12 (951441) w/D-74 MPa Plus	24 VAC, 10 A, 50/60 Hz	50-780 ipm (1.3-19.8 m/min.)	.023-5/64 in. (0.6-2.0 mm)	60 lb. (27 kg) coil with optional wire reel assembly (108008)	Single-wire model: 160 lb. (73 kg) Dual-wire model: 207 lb. (94 kg)
16 ft. (4.9 m) Boom	SS-74D16 (951527) w/S-74D SS-74 MPa Plus-16 (951439) w/S-74 MPa Plus	DS-74D16 (951536) w/D-74D DS-74 MPa Plus-16 (951442) w/D-74 MPa Plus					Single-wire model: 210 lb. (95 kg) Dual-wire model: 280 lb. (127 kg)

70 Series Remote Configurations See literature M/3.0

Remote wire feeder control box and wire drive assembly for non-Miller boom applications.



Single-wire control box
300881 S-74S
300882 S-74D
300738 S-74 MPa Plus

Note: MPa Plus wire drive motor assemblies and control cables are only for use with MPa Plus control boxes.



Wire drive motor assembly
300904 Standard left-hand drive
300740 MPa Plus left-hand drive
 MPa Plus drive can be used with push-only guns, OR XR-Aluma-Pro™ Plus and XR™-Pistol Plus push-pull guns.

Motor control cable
 Standard: 11 conductor
 MPa Plus: 14 conductor

Motor control cable
 11 conductor

Motor control cable
 Standard: 11 conductor
 MPa Plus: 14 conductor



Push-only wire drive motor assembly
300741001 Standard right-hand drive
300741 MPa Plus right-hand drive

Dual-wire control box
300886 D-74S
300887 D-74D
300739 D-74 MPa Plus

Wire drive motor assembly
300904 Standard left-hand drive
300740 MPa Plus left-hand drive
 MPa Plus drive can be used with push-only guns, OR XR-Aluma-Pro™ Plus and XR™-Pistol Plus push-pull guns.

Heavy Industrial • CV DC

Use with CV, DC power sources.

Processes

- MIG (GMAW) ▪ Flux-cored (FCAW)
- Pulsed MIG (GMAW-P) with MPa Plus control and optional MPa power source

Suggested power sources/guns

- Same as 70 Series

Most popular accessories

- Motor Control Cable (11 conductor) 254935010 10 ft. (3 m) 254935025 25 ft. (7.6 m) For push-only gun configurations
- MPa Plus Motor Control Cable (14 conductor) 254864010 10 ft. (3 m) 254864025 25 ft. (7.6 m) 254864050 50 ft. (15.2 m) For MPa Plus configurations only – single-wire or left side of dual-wire



▪ **Feeder Base** 195369
 For use with spooled wire
 Visit MillerWelds.com or your distributor for other Miller® options and accessories.



For more detailed information, visit

MillerWelds.com/guns-torches

Product Guide

Model	Page	Class	MIG	Pulsed MIG*	Flux-cored**	Hard	Wire Types			Wire Diameter Capacity	Available Cable Lengths	Typical Applications		
							Flux-cored		Alum.					
							Dual-shld	Self-shld						
MIGmatic™ M-100 MIG Gun	23	●	●	●	●	●	●	●	CV**	●	.023-.045 in. (0.6-1.2 mm)	10 ft.	Light industrial steel fabrication	Steel
MIGmatic™ M-150 MIG Guns	23	●	●	●	●	●	●	●	CV**	●	.023-.045 in. (0.6-1.2 mm)	10, 12 or 15 ft.	Light industrial steel fabrication	
MDX™-100 MIG Gun	24	●	●	●	●	●	●	●	CV**	●	.023-.045 in. (0.6-1.2 mm)	10 ft.	Light industrial steel fabrication	
MDX™-250 MIG Guns	24	●	●	●	●	●	●	●	CV**	●	.023-.045 in. (0.6-1.2 mm)	10, 12 or 15 ft.	Industrial steel fabrication	
MDX™-250 EZ-Select™ MIG Guns	24	●	●	●	●	●	●	●	CV**	●	.023-.045 in. (0.6-1.2 mm)	15 ft.	Industrial steel fabrication	
Bernard® BTB MIG Guns	25	●	●	●	●	●	●	●	CV**	●	.023-1/8 in. (0.6-3.2 mm)	10, 15, 20, or 25 ft.	Heavy industrial steel fabrication	
Bernard® Clean Air™ Fume Extraction Guns with Straight Handle	26	●	●	●	●	●	●	●	CV**	●	.023-1/8 in. (0.6-3.2 mm)	8, 10, 12, 15, 20, or 25 ft.	Heavy industrial steel fabrication	
Bernard® Clean Air™ Fume Extraction Guns with Curved Handle	26	●	●	●	●	●	●	●	CV**	●	.023-5/64 in. (0.6-2.0 mm)	8, 10, 12, 15, 20, or 25 ft.	Heavy industrial steel fabrication	
Bernard® Dura-Flux™ Guns with Replaceable Liner	26	●	●	●	●	●	●	●	CV**	●	.045-5/64 in. (1.2-2.0 mm)	8, 10, 12, 15, 20, or 25 ft.	Heavy industrial steel fabrication	
Bernard® Dura-Flux™ Guns with Fixed Liner	26	●	●	●	●	●	●	●	CV**	●	1/16-3/32 in. (1.6-2.4 mm)	8, 10, 12, 15, 20, or 25 ft.	Heavy industrial steel fabrication	
Spoolmate™ Spool Guns	27	●	●	●	●	●	●	●		●	100/200/3035 models: .023-.035 in. (0.6-0.9 mm) 150 model: .030-.035 in. (0.8-0.9 mm)	100 model: 12 ft. 150/200/3035 models: 20 ft.	Light industrial aluminum fabrication	Aluminum
Spoolmatic® Spool Guns	28	●	●	●	●	●	●	●	CV**	●	.030-1/16 in. (0.8-1.6 mm)	15 or 30 ft.	Industrial aluminum fabrication	
XR-Aluma-Pro™ Lite Push-Pull Gun	29	●	●	●	●	●	●	●		●	.030-.047 in. (0.8-1.2 mm)	25 ft.	Industrial aluminum fabrication	
XR-Aluma-Pro™ Push-Pull Guns	29	●	●	●	●	●	●	●		●	.030-1/16 in. (0.8-1.6 mm)	15, 25 or 35 ft.	Heavy industrial aluminum fabrication	
XR™ Pistol Push-Pull Guns	29	●	●	●	●	●	●	●		●	.030-1/16 in. (0.8-1.6 mm)	Pistol: 15 or 30 ft. Pistol-Pro: 15, 25 or 35 ft.	Heavy industrial aluminum fabrication	

Product Key

Class: ● Light industrial ● Industrial ● Heavy industrial Capability: ● Designed for this process ● Capable of this process

*Requires MPa inverter power source. **Certain self-shielded wires require CV output. Miller recommends a CV power source whenever possible.

MIGmatic™ M-Series MIG Guns

See literature AY/15.0

An ideal match for Miller® all-in-one MIG machines or other Miller wire feeders.



Three-piece nozzle construction extends nozzle life by reducing wear and helps prevent rocking of nozzle on contact tip adapter.

Interchangeable contact tips and monocoil liners help reduce parts inventory.

Brass contact tip adapter helps prevent galling, sticking and stripping of threads.

Steel spring strain relief protects power cable from wear and helps prevent liner from kinking, allowing better wire feedability.

Light industrial ●

Processes

- MIG (GMAW) ■ Flux-cored (FCAW)

Suggested power sources

- Millermatic® 141/211 (M-100/M-150) (pg 7)
- Multimatic 200 (M-150) (pg 37)
- Multimatic 215 (M-100/M-150) (pg 37)

Most popular accessories

- MIGmatic M-Series Consumable Kits (pg 117)
 - 234607 .023 in. (0.6 mm)
 - 234608 .030 in. (0.8 mm)
 - 234609 .035 in. (0.9 mm)
- MIGmatic M-Series Guns AccuLock™ Conversion Kit 1880269
 - Allows M-100 and M-150 MIG guns to upgrade to AccuLock™ MDX™ nozzles and tips (see pg 24)

Visit MillerWelds.com or your distributor for other Miller® options and accessories.

Model	Stock Number	Cable Length	Rated Output	Rated Duty Cycle	Wire Diameter Capacity	Gun Only Net Weight
M-100	(248282)	10 ft. (3 m)	100 A	100% with CO ₂ gas, 60% with mixed gas	.023-.045 in. (0.6-1.2 mm)	3.2 lb. (1.5 kg)
M-150	(249039)	10 ft. (3 m)	150 A	100% with CO ₂ gas, 60% with mixed gas	.023-.045 in. (0.6-1.2 mm)	4.4 lb. (2.0 kg)
	(249040)	12 ft. (3.7 m)				4.7 lb. (2.1 kg)
	(249041)	15 ft. (4.6 m)				6.0 lb. (2.7 kg)

MDX™ Series MIG Guns

See literature AY/15.5

An ideal match for Miller® all-in-one MIG machines or other Miller wire feeders.



Durable, ergonomic handle features rubber overmolding for improved grip and rear swivel to reduce welder fatigue.

AccuLock™ consumables provide long life and superior wire feeding. See below for more information.

Pulse welding capable due to increased copper in the gun cable which ensures reliable performance with CV and pulse waveforms (MDX-250/MDX-250 EZ-Select only).

EZ-Select™ function allows you to conveniently select from up to four weld programs by tapping the MIG gun trigger rather than walking back to the machine. Lights on handle indicate weld program selected (MDX-250 EZ-Select only).



Model	Stock Number	Cable Length	Rated Output	Rated Duty Cycle	Standard Wire Size	Standard Consumables
MDX-100	(1770028)	10 ft. (3 m)	100 A	100% with CO ₂ gas, 60% with mixed gas	.030-.035 in. (0.8-0.9 mm)	AccuLock MDX Series
MDX-250	(1770035)	10 ft. (3 m)	250 A	100% with CO ₂ gas, 60% with mixed gas	.030-.035 in. (0.8-0.9 mm)	AccuLock MDX Series
	(1770036)	12 ft. (3.7 m)	250 A	100% with CO ₂ gas, 60% with mixed gas	.030-.035 in. (0.8-0.9 mm)	AccuLock MDX Series
	(1770037)	15 ft. (4.6 m)	250 A	100% with CO ₂ gas, 60% with mixed gas	.030-.035 in. (0.8-0.9 mm)	AccuLock MDX Series
	(1770038)	15 ft. (4.6 m)	250 A	100% with CO ₂ gas, 60% with mixed gas	.035-.045 in. (0.9-1.2 mm)	AccuLock MDX Series
	(1770041)	10 ft. (3 m)	250 A	100% with CO ₂ gas, 60% with mixed gas	.035-.045 in. (0.9-1.2 mm)	AccuLock S Series
	(1770042)	12 ft. (3.7 m)	250 A	100% with CO ₂ gas, 60% with mixed gas	.035-.045 in. (0.9-1.2 mm)	AccuLock S Series
MDX-250 EZ-Select	(1770043)	15 ft. (4.6 m)	250 A	100% with CO ₂ gas, 60% with mixed gas	.035-.045 in. (0.9-1.2 mm)	AccuLock S Series
	(1770046)	15 ft. (4.6 m)	250 A	100% with CO ₂ gas, 60% with mixed gas	.035-.045 in. (0.9-1.2 mm)	AccuLock S Series
	(1770047)	15 ft. (4.6 m)	250 A	100% with CO ₂ gas, 60% with mixed gas	.030-.035 in. (0.8-0.9 mm)	AccuLock MDX Series

Light industrial ● MDX-100
Industrial ● MDX-250/250 EZ-Select

Processes

- MIG (GMAW) ■ Flux-cored (FCAW)
- Pulsed MIG (GMAW-P) with MDX-250/250 EZ-Select

Suggested power sources

For MDX-100

- Millermatic® 141/211 (pg 7)
- Multimatic® 215 (pg 37)
- Multimatic® 220 AC/DC (pg 38)

For MDX-250

- Millermatic® 212 Auto-Set™ (pg 8)
- Millermatic® 252 (pg 8)
- Millermatic® 255 (pg 9)
- Multimatic® 200 (pg 37)
- Multimatic® 255 (pg 39)

For MDX-250 EZ-Select

- Millermatic® 255 (pg 9)
- Multimatic® 255 (pg 39)

Most popular consumables

AccuLock Consumables

Liners (inches)

- LM1A-10** .023-.025, 10 ft. length
- LM2A-10** .030-.035, 10 ft. length
- LM3A-10** .035-.045, 10 ft. length
- LM1A-12** .023-.025, 12 ft. length
- LM2A-12** .030-.035, 12 ft. length
- LM3A-12** .035-.045, 12 ft. length
- LM1A-15** .023-.025, 15 ft. length
- LM2A-15** .030-.035, 15 ft. length
- LM3A-15** .035-.045, 15 ft. length

Diffusers

- D-M100** MDX-100
- D-M250** MDX-250
- D-MA250** MDX-250 AccuLock S conversion

MDX-100 Nozzles (inches)

- NS-M1200B** 1/2 ID, flush, brass
- NS-M1200C** 1/2 ID, flush, copper
- NS-MFLX** Gasless nozzle

MDX-250 Nozzles (inches)

- AccuLock MDX**
- N-M1200C** 1/2 ID, flush, copper
- N-M1218C** 1/2 ID, 1/8 rec., copper
- N-M5800C** 5/8 ID, flush, copper
- N-M5818C** 5/8 ID, 1/8 rec., copper
- N-M58XC** 5/8 ID, 1/8 ext., copper
- AccuLock S**
- N-A5800C** 5/8 ID, flush, copper
- N-A5818C** 5/8 ID, 1/8 rec., copper
- N-A5814C** 5/8 ID, 1/4 rec., copper

Contact Tips (inches)

AccuLock MDX

- T-M023** .023
- T-M030** .030
- T-M035** .035
- T-M045** .045
- T-M047** 3/64

AccuLock S

- T-A023CH** .023
- T-A030CH** .030
- T-A035CH** .035
- T-A039CH** .039
- T-A045CH** .045

Visit MillerWelds.com or your distributor for other Miller® options and accessories.

AccuLock™ MDX™ Consumables

See literature AY/15.5



AccuLock MDX cutaways shown

Liner lock self-aligns to back of contact tip when gas diffuser is tightened

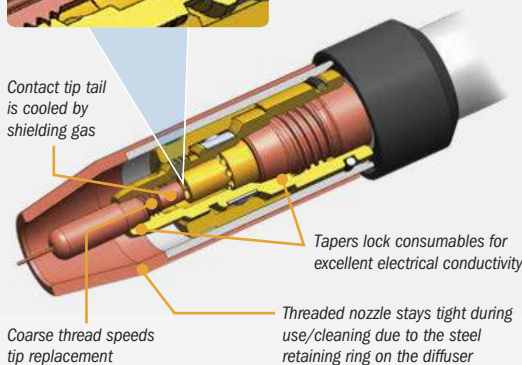

Contact tip tail is cooled by shielding gas

Tapers lock consumables for excellent electrical conductivity

Threaded nozzle stays tight during use/cleaning due to the steel retaining ring on the diffuser

Coarse thread speeds tip replacement

Flawless wire feeding path. Front-loading liner is locked (without set screws) and concentrically aligned with both the contact tip and power pin.

Error-proof liner trimming ensures accurate replacement every time – no measuring required!

Maximize electrical conductivity and tip life.

Tapered mating surface between the contact tip and gas diffuser locks tips in place for optimal performance.



AccuLock MDX

AccuLock S

Upgrade to Bernard® AccuLock S consumables for increased durability and longer life when guns are used in pulsed welding or more industrial applications. See page 25 for more information.

Bernard® Semi-Automatic Guns

Miller offers rugged and reliable Bernard welding guns that have been customized to match the performance of many of its industrial wire feeders and power sources.

BTB Air-Cooled MIG Guns See Bernard literature SP-BTB

Our rugged Bernard BTB MIG guns bring together all the best features and options from our former Q-Gun,™ S-Gun™ and T-Gun™ MIG guns into a single, flexible gun series.



Fully configurable BTB MIG guns help keep your skilled welders comfortable while also increasing their productivity. Choose from a variety of necks, handles and trigger styles to optimize welder ergonomics and weld access, then standardize with a single line of consumables to simplify maintenance and contain costs. **See chart below for a pre-configured BTB MIG gun or visit MillerWelds.com to view a complete list. Configure your BTB MIG gun by visiting BernardWelds.com/ConfigureMyGun**

All guns in chart come with a Miller® power pin and a Universal Conventional liner except:
*Comes with a Miller power pin and a QUICK LOAD® liner AutoLength™ system.

Stock Number	Amperage	Cable Length	Handle	Trigger	Neck	Consumables	Wire Size
Q3015AE8XMC	300	15 ft. (4.6 m) Hytrel® polymer	B Series small curved	Standard	Rotatable med. 45°	Centerfire™ (flush)	.045 in. (1.2 mm)
Q3015AE8EMC	300	15 ft. (4.6 m) Hytrel® polymer	B Series small curved	Standard	Rotatable med. 45°	Centerfire™	.045 in. (1.2 mm)
Q3015TE5EMC	300	15 ft. (4.6 m) Hytrel® polymer	O Series small curved	Standard	Rotatable med. 45°	Quik Tip™	.045 in. (1.2 mm)
Q3015AE8HMC	300	15 ft. (4.6 m) Hytrel® polymer	B Series small curved	Standard	Rotatable med. 45°	Centerfire™	.052 in. (1.3 mm)
Q4015AE8EMC	400	15 ft. (4.6 m) Hytrel® polymer	B Series curved	Standard	Rotatable med. 45°	Centerfire™	.045 in. (1.2 mm)
Q4015TE5EMC	400	15 ft. (4.6 m) Hytrel® polymer	O Series small curved	Standard	Rotatable med. 45°	Quik Tip™	.045 in. (1.2 mm)
Q4015VS3EML*	400	15 ft. (4.6 m) Hytrel® polymer	C Series straight	Standard	Fixed med. 60°	TOUGH LOCK®	.045 in. (1.2 mm)
Q4015MS3EMC	400	15 ft. (4.6 m) Hytrel® polymer	T Series straight	Standard	Fixed med. 60°	TOUGH LOCK®	.045 in. (1.2 mm)
Q4015AE8HMC	400	15 ft. (4.6 m) Hytrel® polymer	B Series curved	Standard	Rotatable med. 45°	Centerfire™	.052 in. (1.3 mm)
Q4020MF8HMC	400	20 ft. (6.1 m) Hytrel® polymer	T Series straight	Standard	Rotatable med. 60°	Centerfire™	.052 in. (1.3 mm)
Q4015AE8IMC	400	15 ft. (4.6 m) Hytrel® polymer	B Series curved	Standard	Rotatable med. 45°	Centerfire™	1/16 in. (1.6 mm)
Q4025MF8IMC	400	25 ft. (7.6 m) Hytrel® polymer	T Series straight	Standard	Rotatable med. 60°	Centerfire™	1/16 in. (1.6 mm)
S4025MF8IMC	400	25 ft. (7.6 m) steel monocoil	T Series straight	Standard	Rotatable med. 60°	Centerfire™	1/16 in. (1.6 mm)
Q4015MS3IMC	400	15 ft. (4.6 m) Hytrel® polymer	T Series straight	Standard	Fixed med. 60°	TOUGH LOCK®	1/16 in. (1.6 mm)
Q4015NS3IMC	400	15 ft. (4.6 m) Hytrel® polymer	T Series straight	Locking	Fixed med. 60°	TOUGH LOCK®	1/16 in. (1.6 mm)

Bernard® AccuLock™ S Consumables See Bernard literature SP-ALS



Load and lock for flawless wire feeding

- Shorten your troubleshooting list by reducing liner misalignment and gaps
- Error-proof your liner installation — no measuring required!

Reduce parts, increase accuracy

- Use AccuLock S consumables on both your Bernard BTB and Miller® MDX-250 MIG guns (see page 24) to simplify inventory and reduce replacement errors

Heavy industrial ●

Processes

- MIG (GMAW) ▪ Flux-cored (FCAW)
- Pulsed MIG (GMAW-P)

Duty cycle ratings

- 100% with CO₂
- 60% with mixed gases

Suggested feeders

- Intellx™ Feeders (pg 13)
- Continuum™ Feeder (pg 15)
- SuitCase® Series (pg 18)
- 20 and 70 Series Feeders (pg 20–22)

Suggested power source

- Millermatic® 350P (pg 10)

Most popular consumables

Centerfire Consumables

Diffusers (amps)

- DS-1 200, 300, small
- D-1 400, 500, 600, large

Brass Nozzles (inches)

- NS-1218B 1/2 ID, 1/8 rec., small

Copper Nozzles (inches)

- NS-5818C 5/8 ID, 1/8 rec., small
- N-5818C 5/8 ID, 1/8 rec., large
- N-5814C 5/8 ID, 1/4 rec., large
- N-3414C 3/4 ID, 1/4 rec., large

Contact Tips (inches)

- T-035 .035
- T-045 .045
- T-052 .052
- T-062 1/16

Quik Tip Consumables

Diffusers (amps)

- D118Q 200, 300, 400
- D114Q 500, 600

Plated Copper Nozzles (inches)

- N1C58Q 5/8 ID
- N1C34HQ 3/4 ID, HD

Contact Tips (inches)

- T1035 .035
- T1045 .045

TOUGH LOCK Consumables

Diffusers (amps)

- 404-18-25 200, 300, 400 SD
- 404-26-25 300, 400, 500, 600 HD

Copper Nozzles (inches)

- 401-4-62 5/8 ID, 1/8 rec., SD
- 401-6-62 5/8 ID, 1/8 rec., HD
- 401-5-62 5/8 ID, 1/4 rec., HD
- 401-5-75 3/4 ID, 1/4 rec., HD

Contact Tips (inches)

- 403-14-35-25 .035 SD
- 403-20-35-25 .035 HD
- 403-14-45-25 .045 SD
- 403-20-45-25 .045 HD
- 403-20-52-25 .052 HD
- 403-20-116-25 1/16 HD

Visit BernardWelds.com or your distributor for additional Bernard consumable options.



For more detailed information, visit BernardWelds.com



Bernard® Semi-Automatic Guns

Industrial-duty fume extraction and flux-cored welding solutions built for the way you weld.



Straight handle
(shown with optional
short nozzle shroud)

Curved handle

Clean Air™ Fume Extraction MIG Guns

See Bernard literature SP-CLA

Maintaining a clean working environment is important and Bernard understands the need for a reliable fume extraction solution. Extract fumes at the weld bead using either of our two models and a FILTAIR® fume extractor.

Clean Air straight handle gun

- Available in 300-, 400-, 500- and 600-amp models
- Compatible with Centerfire, Quik Tip and TOUGH LOCK consumables
- Ergonomic, lightweight handle with rear swivel improves operator comfort

Clean Air curved handle gun

- Available in 300- and 400-amp models
- Compatible with Centerfire, Quik Tip and TOUGH LOCK consumables
- Small lightweight handle maximizes maneuverability and comfort



Replaceable
power cable liner

Fixed power
cable liner

Dura-Flux™ Self-Shielded Flux-Cored Guns

See Bernard literature SP-DF

For structural steel applications, bridge construction and heavy equipment repair, Bernard offers two types of 350-amp self-shielded flux-cored guns.

Dura-Flux gun with replaceable power cable liner

- Replaceable power cable liner allows quick and easy power cable maintenance
- Quik Tip consumables provide excellent heat transfer and electrical conductivity

Dura-Flux gun with fixed power cable liner

- Ultra-heavy-duty steel monocoil power cable is highly resistant to kinking
- Centerfire consumables are easy to use and high performing, providing better arc starts, less spatter and more consistent welds

Bernard® Welding Consumables (cutaways shown)



Centerfire™ consumables

See Bernard literature SP-CFC

- Drop-in contact tip (no tools required to replace tip or nozzle) means quick changeover and reduced downtime
- Spatter shield within nozzle holds tip in place, protects diffuser and directs gas evenly with reduced turbulence
- Diffuser mates securely with contact tip for better conductivity



Quik Tip™ consumables

See Bernard literature SP-QTC

- A quick twist is all it takes to install contact tips
- Threaded taper lock increases tip life and allows excellent heat transfer and electrical conductivity
- Fixed contact tip position for repeatability and consistent quality welds



TOUGH LOCK® consumables

See Bernard literature SP-TLC

- Dual taper technology keeps consumables locked from tip to neck for improved weld consistency, positive electrical conductivity and maximized heat dissipation
- Consumables run cooler, improving performance and extending life



For more detailed information, visit BernardWelds.com



Heavy Industrial ●

Processes

- MIG (GMAW) ▪ Flux-cored (FCAW)
- Pulsed MIG (GMAW-P)

Duty cycle ratings

- 100% with CO₂
- 60% with mixed gases

Suggested feeders

- Intelli™ Feeders (pg 13)
- Continuum™ Feeder (pg 15)
- SuitCase® Series (pg 18)
- 20 and 70 Series Feeders (pg 20-22)

Suggested power source

- Millermatic® 350P (pg 10)

Suggested fume extractor

- FILTAIR® 130 (pg 99)

Most popular consumables

Centerfire Consumables

Diffusers (amps)

DS-1 300, small

D-1 400, 500, 600, large

Copper Nozzles (inches)

NS-5818C 5/8 ID, 1/8 rec., small

N-5818C 5/8 ID, 1/8 rec., large

N-5814C 5/8 ID, 1/4 rec., large

N-3414C 3/4 ID, 1/4 rec., large

Contact Tips (inches)

T-035 .035

T-045 .045

T-052 .052

T-062 1/16

Contact Tip Insulator (Dura-Flux only)

7010024 Fixed power cable liner

Contact Tip Holder (Dura-Flux only)

7010026 Fixed power cable liner

Quik Tip Consumables

Diffusers (amps)

D118Q 300, 400

D114Q 500, 600

Plated Copper Nozzles (inches)

N1C58Q 5/8 ID

N1C34Q 3/4 ID

Contact Tips (inches)

T1035 .035

T1045 .045

T1116 1/16

Contact Tip Insulator (Dura-Flux only)

7010062 Replaceable power cable liner

TOUGH LOCK Consumables

Diffusers (amps)

404-44-25 300, 400, 500, 600 HD

Copper Nozzles (inches)

401-6-62 5/8 ID, 1/8 rec., HD

401-5-75 3/4 ID, 1/4 rec., HD

Contact Tips (inches)

403-20-35-25 .035 HD

403-20-45-25 .045 HD

403-20-52-25 .052 HD

403-20-116-25 1/16 HD

Visit BernardWelds.com or your distributor for additional Bernard consumable options.

Spoolmate™ Spool Guns

Reliable and economical spool guns designed for home hobbyists and light fabricators.



Spoolmate 100

Spoolmate 100 includes carrying case that holds gun and cable, extra contact tips, nozzle and wire (wire sold separately).

Spoolmate 100 See literature M/1.45

Light industrial gun for 4043 series aluminum wire rated at 135 amps at 30 percent duty cycle.

12-foot direct-connect cable with heavy-duty strain relief provides extended reach and accessibility to your work.

Dual V-knurled drive rolls with adjustable tension control for consistent feeding of different types of wire.

Clear spool canister protects the wire and allows easy view of spool.

Includes carrying case, extra contact tips and nozzle.



Spoolmate 150

PORTABLE!

Spoolmate 150 See literature M/1.46

Light industrial gun for 4000 or 5000 series aluminum wire rated at 150 amps at 60 percent duty cycle.

20-foot direct-connect cable with heavy-duty strain relief provides extended reach and accessibility to your work.

Heavy-duty head tube.

Dual V-knurled drive rolls with adjustable tension control for consistent feeding of different types of wire.

Clear spool canister protects the wire and allows easy view of spool.



Spoolmate 200

Spoolmate 200 See literature M/1.47

Light industrial gun for 4000 or 5000 series aluminum wire rated at 160 amps at 60 percent duty cycle.

20-foot weld/control cables with strain relief and sheath provide extended reach and accessibility to your work.

Wire feed speed adjustment on the gun – not machine – for easy setup.

Easy access to drive assembly and drive rolls.

Two-stage trigger with built-in gas valve allows for gas preflow/postflow.

Toolless head tube removal allows easy replacement. Comes standard with heavy-duty head tube. Three optional head tubes available.



Spoolmate 3035

Spoolmate 3035 See literature M/1.5

Light industrial gun for 4000 or 5000 series aluminum wire rated at 150 amps at 60 percent duty cycle.

20-foot weld/control cables with strain relief and sheath provide extended reach and accessibility to your work.

Light weight and well balanced for operator comfort.

Clear spool canister protects the wire and allows easy view of spool.

Easy-to-remove head tube assembly.

Light Industrial

Use with CV, DC power sources.

Processes

- MIG (GMAW) with aluminum and other soft alloy wires
- MIG (GMAW) with hard wires

Suggested power sources

For Spoolmate 100

- Millermatic® 141/211 (pg 7)
- Multimatic™ 200/215 (pg 37)
- Multimatic™ 220 AC/DC (pg 38)
- Syncrowave® 210 (pg 53)
(requires MIG accessory kit 301254)

For Spoolmate 150

- Millermatic® 211 (pg 7)
- Multimatic™ 200 (pg 37) effective with serial number MF364047N
- Multimatic™ 215 (pg 37)
- Multimatic™ 220 AC/DC (pg 38)
- Syncrowave® 210 (pg 53)
(requires MIG accessory kit 301254)

For Spoolmate 200

- Millermatic® 212 Auto-Set™ (pg 8)
- Millermatic® 252 (pg 8)
- Millermatic® 255 (pg 9)
- Multimatic™ 255 (pg 39)
- Bobcat™ 200 Air Pak™ (pg 73)

For Spoolmate 3035

- Direct connect to vintage Millermatic 210/212 tapped-voltage models
- Millermatic® 141/211 (pg 7)
(requires SGA 100 control 043856)
- Bobcat™ 225 (pg 74)
(requires SGA 100C control 043857)

Most popular accessories

For Spoolmate 200

- 45-Degree Head Tube 300591
- 9-Inch Extension Head Tube 300592
- 5-Inch Head Tube 243385
- Spoolmatic Adapter Cable 195287
Allows connection to older Millermatic 210 and 212 (non-Auto-Set)

For Spoolmate 3035

- SGA 100 043856 (pg 122)
- SGA 100C 043857 (pg 122)
- Heavy-Duty Head Tube 195375

Visit MillerWelds.com or your distributor for other Miller® options and accessories.

Model/ Stock Number	Welding Current Rating	Wire Feed Speed	Wire Type and Diameter Capacity	Maximum Spool Size Capacity	Dimensions	Net Weight with Cable Assembly
Spoolmate 100 (300371)	135 A at 30% duty cycle	5-625 ipm (1.7-15.9 m/min.) Wire speed dependent on power source used	Aluminum .030-.035 in. (0.8-0.9 mm) Solid steel .023-.035 in. (0.6-0.9 mm) Stainless .023-.035 in. (0.6-0.9 mm)	4 in. (102 mm)	H: 11.5 in. (291 mm) W: 3 in. (76 mm) L: 13 in. (330 mm)	6 lb. (2.7 kg) 9 lb. (4.1 kg) with case
Spoolmate 150 (301272)	150 A at 60% duty cycle	115-715 ipm (2.9-18.1 m/min.) Wire speed dependent on power source used	Aluminum .030-.035 in. (0.8-0.9 mm) Solid steel .030-.035 in. (0.8-0.9 mm) Stainless .030-.035 in. (0.8-0.9 mm)	4 in. (102 mm)	H: 11.5 in. (291 mm) W: 3 in. (76 mm) L: 12.5 in. (318 mm)	7.3 lb. (3.2 kg)
Spoolmate 200 (300497)	160 A at 60% duty cycle,	70-875 ipm (1.8-22.2 m/min.)	Aluminum .030-.035 in. (0.8-0.9 mm) Solid steel .023-.035 in. (0.6-0.9 mm) Stainless .023-.035 in. (0.6-0.9 mm)	4 in. (102 mm)	H: 9 in. (229 mm) W: 2.5 in. (64 mm) L: 14.5 in. (368 mm)	11 lb. (5 kg)
Spoolmate 3035 (195016)	150 A at 60% duty cycle, 200 A at 60% duty cycle with optional heavy-duty head tube	115-715 ipm (2.9-18.1 m/min.)	Aluminum .030-.035 in. (0.8-0.9 mm) Solid steel .023-.035 in. (0.6-0.9 mm) Stainless .023-.035 in. (0.6-0.9 mm)	4 in. (102 mm)	H: 11.5 in. (291 mm) W: 2.25 in. (57 mm) L: 8 in. (203 mm)	9.1 lb. (4.1 kg)

Spoolmatic® Spool Guns

Portable, aluminum wire feeder for industrial applications.



Spoolmatic

PORTABLE!

Spoolmatic See literature M/1.73

Integrated spool canister rotates 180 degrees for operator flexibility and comfort.

Available in 15- or 30-foot cable lengths, providing flexibility to be used in the shop and in the field.

Two-stage trigger with built-in gas valve allows for gas preflow and eliminates the need to purge long gas lines.

Wire feed speed adjustment on the gun handle and reversible drive rolls save time and money.

Quick-change, single-turn contact tip provides excellent performance and is easy to replace.

Spoolmatic Pro (additional features) See literature M/1.76

Wire tension settings. 4000- or 5000-specific tension settings ensure the very best wire feeding performance and arc consistency.

More durable motor and drive design improves feedability and arc consistency while helping reduce downtime and maintenance costs.

Easy access to drive assembly and removable toolless head tube reduce service time by allowing a means of changing drive rolls and head tube, or performing routine maintenance, without disassembly of gun.

Easy-to-rotate, self-seating head tube allows for better access into tight spots, preventing leaks and providing excellent current transfer. Head tubes are common with the XR-Aluma-Pro™ and XR™-Pistol-Pro guns.

Head tube options in several different lengths and bend configurations are available for when a standard head tube doesn't fit the application.



Spoolmatic Pro

*Spoolmatic Pro requires wire kit (230708) to run 1/16 in. (1.6 mm) wire.

Industrial ● CC CV DC

Use with CC/CV, DC power sources.

Processes

- MIG (GMAW) with aluminum and other soft alloy wires
- MIG (GMAW) with hard wires
- Pulsed MIG (GMAW-P) with optional pulsing power source

Suggested power sources

- Millermatic® 212 Auto-Set™ (pg 8)
- Millermatic® 252 (pg 8)
- Millermatic® 255 (pg 9) (non-Pro gun only)
- Millermatic® 350P/350P Aluminum (pg 10) (non-Pro gun only)
- Multimatic® 255 (pg 39) (non-Pro gun only)
- Bobcat™ 200 Air Pak™ (pg 73)
- Bobcat™ Series (pg 74) (requires WC-115A with contactor 137546011)

These power sources require WC-24 control (137549)

- AlumaPower™ MPa (pg 11)
- Invision™ MPa (pg 14)
- Dimension™ 650/650 ArcReach® (pg 41)
- XMT® Series (pg 42-45)
- Trailblazer® Series (pg 76-78)

Most popular accessories

- WC-115A 137546 (pg 122)
- WC-115A with contactor 137546011 (pg 122)
- WC-24 137549 (pg 122)

Visit MillerWelds.com or your distributor for other Miller® options and accessories.

Model/Stock Number	Welding Current Rating	Wire Feed Speed	Wire Type and Diameter Capacity	Maximum Spool Size Capacity	Dimensions	Gun Only Net Weight
Spoolmatic (195156) 15 ft. (4.5 m) cable (130831) 30 ft. (9 m) cable	200 A at 100% duty cycle	70-875 ipm (1.8-22.2 m/min.) Wire speed dependent on control or Millermatic used	Aluminum* .030-1/16 in. (0.8-1.6 mm) Hard wire .030-.045 in. (0.8-1.1 mm)	4 in. (102 mm)	H: 10.25 in. (260 mm) W: 2.5 in. (64 mm) L: 15.125 in. (384 mm)	2.9 lb. (1.3 kg)
Spoolmatic Pro (301147) 15 ft. (4.5 m) cable (301148) 30 ft. (9 m) cable	200 A at 100% duty cycle	70-900 ipm (1.8-23 m/min.) Wire speed dependent on control or Millermatic used			H: 10.75 in. (273 mm) W: 2.5 in. (64 mm) L: 15.375 in. (390 mm)	3.0 lb. (1.4 kg)

Miller recommends



Filler metals are a critical component in any weld project. They become part of your end product and choosing the right filler metal can affect the look and quality of your weld.

To make your filler metal choice easier, **Hobart offers a FREE app for download** on both Android™ and Apple® devices. Features of the app include:

- Recommendations for aluminum, carbon steel and stainless steel welding
- Calculates the amount of filler metal needed for your job
- Heat input calculator
- Hardfacing cross-reference function

Download the Filler Metal Selector and Calculator app today.

XR™ Push-Pull Guns

XR-Aluma-Pro and XR-Pistol guns work in conjunction with an XR-AlumaFeed or select Millermatic machines to provide the best solution for push-pull applications.



Threaded quick-change 360-degree rotatable head tubes are available in different bends and lengths for even those hard-to-reach welds. Over 30 different styles to fit your application and welder's preference.

Wire tension settings (except XR-Pistol). 4000- or 5000-specific tension settings ensure the very best wire feeding performance and arc consistency.

Heavy-duty construction. All internal components are designed to provide long lasting performance and feeding precision.

XR-Aluma-Pro™ Lite See literature M/1.75

Lightest weight gooseneck-style gun features rear trigger that allows access to hard-to-reach welds.

XR-Aluma-Pro™ See literature M/1.71

Robust professional-grade gun has the highest duty cycle rating in its class.

Easy access to drive assembly and removable toolless head tube reduce service time by allowing a means of changing drive rolls and head tube, or performing routine maintenance, without disassembly of gun.



XR™-Pistol See literature M/1.73

Reliable, cost-effective gun for light- to medium-industrial applications.

XR™-Pistol-Pro See literature M/1.74

Exceptional aluminum welding results for heavy-industrial applications.

Most durable motor and drive design improves feedability and arc consistency while helping reduce downtime and maintenance costs.

Easy access to drive assembly and removable toolless head tube reduce service time by allowing a means of changing drive rolls and head tube, or performing routine maintenance, without disassembly of gun.

Industrial ● XR-Aluma-Pro Lite
Heavy Industrial ● XR-Aluma-Pro and all Pistol models

 Use with CC/CV, DC power sources.

Processes

- MIG (GMAW) with aluminum wire (capable of other wires with optional hardware kits)
- Pulsed MIG (GMAW-P) with optional pulsing power source

Suggested feeders/controls

- XR-AlumaFeed® SuitCase® (pg 11)

Suggested power sources

- Millermatic® 252 (pg 8)
- Millermatic® 255 (pg 9) (XR-Aluma-Pro guns only)
- Millermatic® 350P/350P Aluminum (pg 10)
- Multimatic® 255 (pg 39) (XR-Aluma-Pro guns only)

These power sources require an XR-AlumaFeed SuitCase

- AlumaPower™ MPa (pg 11)
- Deltaweld® 350/500 (pg 12) (14-pin receptacle models only)
- Invision™ MPa (pg 14)
- XMT® Series (pg 42-45)
- Trailblazer® Series (pg 76-78)

Most popular accessories

- Hardwire Liner Kit 198377

Visit MillerWelds.com or your distributor for other Miller® options and accessories.

*Dependent on control box or Millermatic used. **Requires wire kit (230708) to run 1/16 in. (1.6 mm) wire.

Model	Cable Length				Welding Current Rating	Wire Feed Speed*	Wire Type and Diameter Capacity	Dimensions	Gun Only Net Weight
	15 ft. (4.6 m)	25 ft. (7.6 m)	30 ft. (9 m)	35 ft. (10.6 m)					
XR-Aluma-Pro Lite (Air-cooled)	–	(300948)	–	–	175 A at 60% duty cycle	70–900 ipm (1.8–23 m/min.)	Aluminum .030–.047 in. (0.8–1.2 mm)	H: 4 in. (102 mm) W: 1.9 in. (48 mm) L: 15 in. (381 mm)	2.0 lb. (0.9 kg)
XR-Aluma-Pro (Air-cooled)	(301568)	(301569)	–	(301570)	300 A at 100% duty cycle	70–900 ipm (1.8–23 m/min.)	Aluminum** .030–1/16 in. (0.8–1.6 mm)	H: 5 in. (127 mm) W: 2.5 in. (64 mm) L: 17 in. (432 mm)	2.5 lb. (1.1 kg)
XR-Aluma-Pro (Water-cooled)	(301571)	(301572)	–	(301573)	400 A at 100% duty cycle				2.9 lb. (1.3 kg)
XR-Pistol (Air-cooled)	(198127)	–	(198128)	–	200 A at 100% duty cycle	70–875 ipm (1.8–22.2 m/min.)	Aluminum .030–1/16 in. (0.8–1.6 mm)	H: 7.375 in. (187 mm) W: 1.875 in. (48 mm) L: 10.625 in. (270 mm)	2.2 lb. (1 kg)
XR-Pistol (Water-cooled)	(198129)	–	(198130)	–	400 A at 100% duty cycle				2.4 lb. (1.1 kg)
XR-Pistol-Pro (Air-cooled)	(300782)	(300783)	–	(300784)	200 A at 100% duty cycle	70–900 ipm (1.8–23 m/min.)	Aluminum** .030–1/16 in. (0.8–1.6 mm)		2.2 lb. (1 kg)
XR-Pistol-Pro (Water-cooled)	(300786)	(300787)	–	(300788)	400 A at 100% duty cycle				2.4 lb. (1.1 kg)



Automation

For more detailed information, visit



MillerWelds.com/automation

To order automation solutions: Contact local Miller district manager or email MWASales@MillerWelds.com

For automation service/parts: Call **1-630-653-6819** or email MWAService@MillerWelds.com

PERFORMARC™ ROBOTIC WELDING SYSTEM



A family of pre-engineered automation cells to increase productivity and improve weld quality.

Fast installation. Pre-wired and pre-assembled make setup fast and easy. Most systems are up and running in under two hours from delivery (connect power/wire/gas and mounting tooling).

Integrated controls. Control station and full-color teach pendant keep the operator informed, maximizing production uptime.

Flexibility. Fully welded frame allows easy relocation and reconnection as production plans or layouts change.

Increased productivity. Operator can load and inspect parts while robot is welding.

A/B 180° Indexing Table Single-station load/unload system



PA250M 250 lb./side, 60 in. manually indexed table
PA350S 350 lb./side, 66 in. servo indexing table
PA750S/PA750SW 750 lb./side, 92 or 108 in. servo indexing table

Side-by-Side Two-station load/unload system



**Robot between dual head and tailstock/
single- or dual-robot
configuration.**

PA1100SS 1,100 lb./side, 120 in. long x 44 in. turning diameter
PA2200SS 2,200 lb./side, 120 in. long x 66 in. turning diameter

A/B 180° Indexing H-Frame Single-station load/unload system

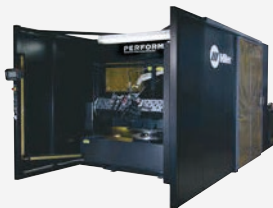

**Dual head and tailstock/
single- or dual-robot
configuration.**

PA550H 550 lb./side, 48 in. long x 34 in. turning diameter on 92 in. servo indexer
PA550HW 550 lb./side, 60 in. long x 40 in. turning diameter on 108 in. servo indexer
PA1100HW 1,100 lb./side, 60 in. long x 40 in. turning diameter on 108 in. servo indexer

A/B 180° Indexing Ferris Wheel Single-station load/unload system



**Dual head and tailstock/
single-, dual- or triple-
robot configuration.**

PA1100FW 1,100 lb./side, 118 in. long x 43 in. turning diameter

Laser Welding/Cladding System



PL1100HW 1,100 lb./side,
60 in. long x 34 in. turning diameter on
108 in. servo indexer

Integrated laser solution with fiber cable management.

- Autogenous, hotwire, coldwire or hybrid processes
- Class 1 laser-safe enclosure
- Available with fiber or diode laser configurations

To order automation solutions: Contact local Miller district manager or email MWASales@MillerWelds.com

For automation service/parts: Call 1-630-653-6819 or email MWAService@MillerWelds.com

Active Wire Process (AWP)

Active wire is an advanced short arc welding process combining the robot motion path, welder waveform and servo wire feed control simultaneously reversing the wire at the short circuit to control the weld deposition precisely.

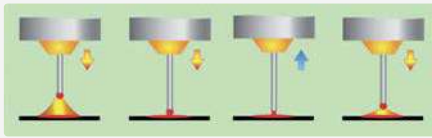

Spatter control. Spatter is virtually eliminated in all phases of the weld using mixed argon 90/10 or 100 percent CO₂ gas.

Fast and clean arc striking. At the moment the wire touches the base the wire is reversed, reducing arc strike spatter by up to 90 percent.

Flexibility. Large variations in torch angle are possible, allowing push-pull in and out of corners without increasing spatter.

Appearance. The precise nature of the process allows many customers an alternative to TIG welding.

Wide range of materials. Mild steels, stainless steels and aluminum from thin to medium gauge benefit from AWP.

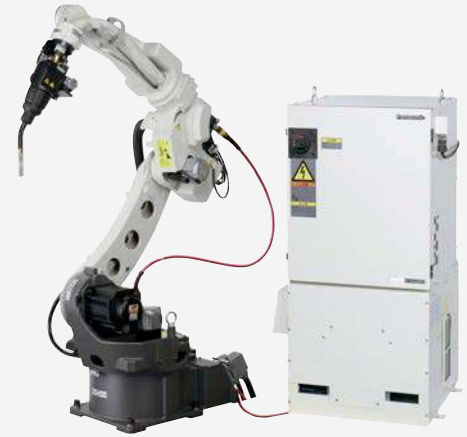

Thick Plate Welding

Fast and easy programming even on the most complex multi-pass weldments. All required commands and sensor setup in a single menu screen. Welding procedures can be developed quickly and transported easily from part to part.

Graphical, menu-driven interface. Pop-up graphical windows allow for fast programming of any welding joint in a single location.

Multi-layer path control. Easy-to-use interface to sequence the location of starts/stops and create multi-layer weld paths with appropriate offsets.

Advanced sensors. High-voltage touch sensing with menu-driven touch macros, a specialized high-amperage arc sensor system, and adaptive fill capability allow the weld process to adapt to incoming/varying production parts.



DeskTop Programming and Simulation (DTPS)

Software allows the development of programs offline, minimizing robot downtime and maximizing throughput and productivity.

Specialized software generates programs and simulates the actual taught paths from your desktop.

Native language programming. Same language and functions that the technician will see on the teaching pendant, making program generation off-line easier than competitive code-based systems.

Simplified file transfer. Transfer robot programs between robot types, sizes and controller generations.

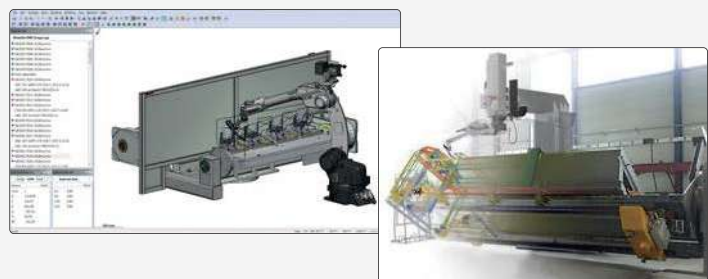

Automation Components



Auto-Continuum™ power sources (pg 16)



Insight Core™, Centerpoint™ and ArcAgent™ Welding Intelligence™ (pg 67-69)



Tregaskiss® robotic MIG guns and reamers (pg 34-35)



FILTAIR® weld fume extraction system with low profile hood (pg 102-103)



Miller recommends Hobart® filler metals (visit HobartBrothers.com)



Jetline® Fixed Automation

Jetline offers a partnership to ensure you find the right solution to improve your weld quality and productivity – from design to installation, our engineers will help you get the results you need to stay competitive. Learn more at MillerWelds.com/jetline



Longitudinal Seam Welding Systems



Jetline longitudinal seam welders deliver speed and precision. Features include linear welding, high-volume cylinder production, joining thin-gauge or coiled sheets and more.

- High-precision travel and positioning result in weld accuracy
- Complete solution, single source
- Bolt-on control modules provide adaptability
- Aluminum hold-down fingers with copper tips absorb and dissipate heat
- Toe-touch tapeswitch control activates finger clamping
- Range includes:
 - External: flat sheets, cylinders and more
 - Internal: flat sheets and internal welds on cylinders
 - Combination: internal and external welds
 - Elevating: seam welder raises and lowers to accommodate diameters up to 96-inch OD
 - Bench: small seam welder for welding shorter, smaller parts

Circumferential Welding Systems

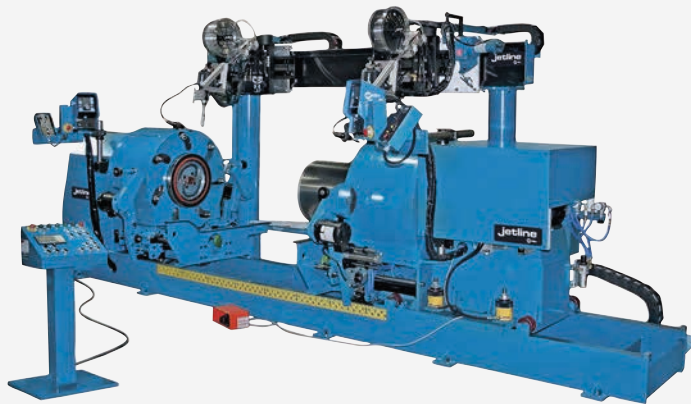

Jetline precision lathes and light-, medium- and heavy-duty circumferential welders handle a wide variety of part sizes and dimensions – from less than one pound up to 10,000 pounds, and from one inch up to 60 inches in diameter. Whatever the challenge, Jetline can work with you to find the perfect solution.

- Powered variable speed headstock
- Adjustable tailstock can be moved along the bed to accommodate differing part lengths
- Air-operated tailstocks apply a constant clamping pressure to the part throughout the welding cycle
- Range includes:
 - Precision: 500-pound maximum part
 - Light duty: 500-pound maximum part
 - Medium duty: 2,000-pound maximum part
 - Heavy duty: 10,000-pound maximum part

Weld Head Locators



Jetline precision weld head locators provide a universal solution to position weld heads for circumferential and linear welding applications. With a variety of control systems, bolt-on accessories and base options, we can design the solution to meet your GTAW, GMAW and PAW needs.

- Jetline manipulators allow for simplified torch positioning
- Linear rails provide high-precision movement of the boom for linear welding
- 360 degrees of column rotation allows the weld head to be positioned over multiple fixtures
- Remote pushbutton pendant for weld head locator operation
- Range includes:
 - 6 x 6 foot
 - 9 x 9 foot
 - 12 x 12 foot

To order Jetline automation solutions: Contact local Miller district manager or email JetlineSales@MillerWelds.com

For Jetline service: Call 1-630-653-6819 or email JetlineService@MillerWelds.com

9900 Controller



The 9900 controller is a touch screen industrial computer with an intuitive graphical user interface.

- Large 15-inch touch screen panel with industrial PC
- User-friendly graphical interface and easy programming using industry-standard terms
- Graphical representation of the weld parameters during the weld and programming
- Standard configuration controls up to 15 channels
- Ethernet and fiber optic communication for flexibility and speed
- Software options

9700 Controller



The 9700 controller is the standard Jetline control and sequencer used on our motor-driven equipment.

- Microprocessor-based control technology
- User-friendly front panel layout with large-screen graphic backlit display
- Closed-loop control for higher accuracy and stability
- Modbus® provides enhanced control of compatible Dynasty® and Maxstar® power sources for a single point of programming
- Processes include GTAW, GMAW, SAW and PAW
- Integrates with other optional Jetline components including arc length control, cold wire and hot wire feeders, and oscillators

Arc Length Control



Jetline arc length control maintains a constant arc length by controlling arc voltage in gas tungsten arc welding (GTAW) or plasma arc welding (PAW) applications.

- Regulation of welding voltage for precise, repeatable welds
- Provides consistent performance and results
- Touch retract allows starting gap to be automatically preset in TIG (GTAW) applications
- Simplified setup and operation requires minimal operator intervention
- Standard package includes 9790 arc length control and 6-inch arc length control actuator

Cold Wire Feed



Jetline cold wire feeder is used for automated gas tungsten arc welding (GTAW) or plasma arc welding (PAW) applications to add “fill” to a weld joint.

- Cold wire feeder system includes 9700W microprocessor control, four-roll feed assembly and wire guide positioner
- 9700W microprocessor controller offers a simple menu for setup and operation
- Four-roll feed assembly optimizes feeding of both hard and soft wires
- Wire guide positioner provides fine adjustment to position where the wire enters the weld puddle
- Optional clear spool cover protects the wire from the dust and dirt from the manufacturing environment



Tregaskiss® Robotic Guns

Available with all PerformArc® robotic welding systems, fully configurable Tregaskiss TOUGH GUN® TA3 and CA3 robotic MIG guns are engineered for accurate, reliable and repeatable performance that maximizes production uptime and throughput. Parts can be replaced with minimal downtime and little to no impact on Tool Center Point (TCP).



TOUGH GUN
TA3 MIG gun

TOUGH GUN
CA3 MIG gun

Air-Cooled MIG Guns

See Tregaskiss literature SP-TA3 and SP-CA3

TA3 robotic MIG gun

- Runs internal to the robot arm
- Available in 350-amp models at 100 percent duty cycle with mixed gases
- Available as a complete package from the power pin to the contact tip
- Durable neck clamp provides consistent clamping force for repeatability and TCP accuracy

CA3 robotic MIG gun

- Runs external to the robot arm
- Available in 385-amp models at 100 percent duty cycle with mixed gases
- Replaceable unicable reduces downtime through faster repair and extended service life
- Cable guide minimizes stress on cable connection as the robot articulates
- Durable neck clamp provides consistent clamping force for repeatability and TCP accuracy

Tregaskiss® Fixed Automatic Guns

Tregaskiss fixed automatic MIG guns are engineered for hard tooling automation applications requiring a simple, durable and repeatable MIG gun. These automatic torches can be configured with the same consumables as your Bernard® semi-automatic or Tregaskiss robotic MIG guns to simplify your inventory.

Air-Cooled MIG Guns

See Tregaskiss literature M033

MA1 automatic MIG gun

- Available in 500- and 600-amp models
- Spring-guard strain relief prevents kinking and abrasion
- Air-cooled neck is made from aircraft-grade aluminum

Water-Cooled MIG Guns

See Tregaskiss literature M033 and SP-WCA

MW1 automatic MIG gun

- Available in 450- and 600-amp models
- Spring-guard strain relief prevents kinking and abrasion
- Water-cooled neck is made from stainless steel and is silver brazed and leak tested
- 600-amp water-cooled model has a thread-on heavy-duty nozzle

AW2 automatic MIG gun

- Available in both cable and cableless 600-amp models
- Power cable equipped guns are available in lengths of 3–25 feet in 1/2-foot increments
- Internal threaded connections stay tight inside the anti-vibration compression fit body for good electrical connectivity and longer life



TOUGH GUN
MA1 MIG gun

TOUGH GUN
MW1 MIG gun

TOUGH GUN
AW2 MIG gun

Industrial ●

Process ▪ MIG (GMAW)

Compatible robots for robotic air-cooled guns

- Panasonic®
- ABB®
- COMAU®
- FANUC®
- Kawasaki®
- KUKA®
- Motoman®
- OTC Daihen®
- Reis® (CA3 only)

Packages

- PerformArc Robotic Welding Systems (pg 30)

Most popular accessories

- TOUGH GUN I.C.E.™ (Integrated Cooling Enhancer) Technology – adds water-cooling to air-cooled guns for a boost in duty cycle
- Neck Checking Fixture
- TOUGH GUN TT3E Ethernet Reamer Robotic Nozzle Cleaning Station (pg 35)
- TOUGH GUN TT3A Reamer Robotic Nozzle Cleaning Station (pg 35)

Most popular consumables

- AccuLock™ Consumables (pg 35)
- TOUGH LOCK® Consumables (pg 35)
- QUICK LOAD® Liners (pg 35)
- QUICK LOAD Liner AutoLength™ System (see Tregaskiss literature SP-QLL)

Visit Tregaskiss.com or your distributor for other Tregaskiss options and accessories.



For more information or to configure your Tregaskiss robotic gun online, visit

Tregaskiss.com/ConfigureMyGun



Tregaskiss® TOUGH GUN® TT3 Reamers

See Tregaskiss literature SP-TT3

TOUGH GUN TT3 reamers provide automated spatter removal to help extend the life of your robotic MIG guns and consumables, increasing both production uptime and throughput while benefiting your bottom line.



TOUGH GUN TT3E reamer shown with TOUGH GUN CA3 MIG gun.

Tough on spatter and designed to operate reliably in even the harshest welding environments.

Two models available. TT3A and TT3E (Ethernet model) enhanced with digital Ethernet communication for better integration.

TT3E Ethernet model is designed for durability, serviceability and repeatability. Provides greater control optimization, remote monitoring capability and faster troubleshooting to facilitate increased productivity.

One-year warranty on both TOUGH GUN TT3 reamer models. *Extend your warranty from one year to two years with the addition of a factory-installed Lubricator, OR from one year to three years with the addition of a factory-installed Lubricator, plus exclusive use of Tregaskiss TOUGH GARD anti-spatter liquid.*

Industrial ●

Most popular accessories

- Reamer Lubricator
- Nozzle Detect
- TOUGH GUN Reamer Stand – custom height, quick installation, easy on the budget



- **TOUGH GARD™ Anti-Spatter Liquid**
- **TOUGH GARD Multi-Feed System**

Visit Tregaskiss.com or your distributor for other Tregaskiss options and accessories.



For more information or to configure your TOUGH GUN reamer online, visit

Tregaskiss.com/ConfigureMyGun



Tregaskiss Welding Consumables (cutaways shown)



AccuLock™ R consumables

See Tregaskiss literature SP-ALR

AccuLock contact tips deliver longer life and quick, accurate replacement. Maintaining the proven electrical conductivity and locking benefits of tapered connections, AccuLock consumables are a simple and beneficial upgrade in robotic welding applications.

- The contact tip's long tail centers it in the diffuser prior to engagement of the coarse thread, making it virtually impossible to cross-thread
- A quick 360-degree twist is all it takes to replace the contact tip
- Upgrade from TOUGH LOCK consumables to the new contact tip and AccuLock R diffuser with no effect on Tool Center Point (TCP) in robotic applications
- Compatible with Tregaskiss nozzles and QUICK LOAD® liners

QUICK LOAD® liners

See Tregaskiss literature SP-QLL

- Requires less than half the time and effort to replace compared to conventional liners
- Two-piece system with retainer installed inside the power pin on first use
- No need to cut and waste wire!
- Avoid climbing over robotic tooling or transfer systems to remove the torch from the wire feeder
- Change the liner from a safe zone in the robotic work cell

Most popular consumables

AccuLock Consumables

AccuLock R Diffusers

- D-ATSH** HD for slip-on nozzles
- D-ATTH** HD for thread-on nozzles

Tregaskiss Nozzles (inches)

Slip-on

- 401-6-62** 5/8 ID, 1/8 recessed
- 401-87-62** 5/8 ID, 1/8 stickout

Thread-on

- 401-14-62** 5/8 ID, 1/8 recessed
- 401-20-62** 5/8 ID, 1/8 stickout

AccuLock Contact Tips (inches)

- T-A039CH** .039 copper
- T-A045CH** .045 copper
- T-A039WH** .039 HDP
- T-A045WH** .045 HDP

QUICK LOAD Liners

6 ft. Liners (inches)

- 415-35-6Q** .035-.045
- 415-35-062Q** .035-.045, galvanized
- 415-116-6Q** .045-1/16
- 415-116-062Q** .045-1/16, galvanized

See literature SP-QLL for complete offering. Visit Tregaskiss.com or your distributor for additional Tregaskiss consumable options.



Multiprocess

For more detailed information, visit



MillerWelds.com/multiprocess



Power Source Welding Performance

		Light Industrial			Industrial			Heavy Industrial		
		Multimatic® 200 (page 37)	Multimatic® 215 (page 37)	Multimatic® 220 AC/DC (page 38)	Multimatic® 255 (page 39)	Maxstar® 280 Multiprocess (page 40)	Dynasty® 280 DX Multiprocess (page 40)	XMT® 350 Models (pages 42-45)	XMT® 450 Models (pages 42-45)	Dimension™ 650 (page 41)
Material	Mild Steel	●	●	●	●	●	●	●	●	●
	Stainless Steel	●	●	●	●	●	●	●	●	●
	Aluminum	●	●	●	●	●	●	● ¹	● ¹	●
Material Thickness	Gauge (.020-.125 in.)	●	●	●	●	●	●	●	●	●
	Sheet (.125-.375 in.)	●	●	●	●	●	●	●	●	●
	Plate (.375-1 in.)								●	●
	Plate (1+ in.)								●	●
Wire Size	.023 in.	●	●	●	●	●	●	●	●	●
	.030 in.	●	●	●	●	●	●	●	●	●
	.035 in.	●	●	●	●	●	●	●	●	●
	.045 in.	●	●	●	●	●	●	●	●	●
	.052 in.					●	●	●	●	●
	1/16 in.							●	●	●
	5/64 in.							●	●	●
3/32 in.								●	●	
Process	Short Circuit	★★★★	★★★★	★★★★	★★★★	★★★★	★★★★	★★★★	★★★★	★★★★
	Pulsed Spray				★★★★			★★★★ ²	★★★★ ²	
	Stick	★★	★★	★★	★★★	★★★★	★★★★	★★★★	★★★★	★★★★
	AC TIG			★★★★			★★★★			
	DC TIG	★★★	★★★	★★★★	★★★	★★★★	★★★★	★★★	★★★	★★★
	CAC-A					3/16 in.	3/16 in.	1/4 in.	5/16 in.	3/8 in.

Icon Key

Capability: ● Designed for ● Capable of Process Quality: ★ Good ★★ Better ★★★ Best ★★★★ Optimized
 New! products appear in blue type.

¹ CC/CV and FieldPro™ models are capable of aluminum welding. MPA models are designed for aluminum welding. XR™AlumaFeed SuitCase system is recommended for best results.

² MPA models only.

Multimatic® 200 and 215

See literature DC/12.57 (200) and DC/12.59 (215)



Multi-voltage plug (MVP™) allows connection to common 120- and 240-volt power receptacles without the use of any tools – simply choose the plug that fits the receptacle and connect to the power cord.



See page 121

Welding Capability

Max. 3/8 in. (9.5 mm)	Max. 3/8 in. (9.5 mm)
MIG Mild Steel	MIG Aluminum
Min. 24 ga. (0.6 mm)	Min. 18 ga. (1.2 mm)
Max. 3/16 in. (4.8 mm)	Max. 3/8 in. (9.5 mm)
TIG Mild Steel	Stick Mild Steel
Min. 24 ga. (0.6 mm)	Min. 16 ga. (1.5 mm)

Aluminum welding uses optional Spoolmate 100 and 4000 series aluminum wire **OR** Spoolmate 150 (effective with Multimatic 200 serial number MF364047N) and either 4000 or 5000 series aluminum wire. TIG welding uses optional TIG contractor kit.

Weighing only 29 pounds (200) or 38 pounds (215), these lightweight MIG, stick and TIG welders provide portability on the job.

Impact-resistant, flame-retardant case (200 only) provides strength and durability, while protecting components and welding wire from moisture, dust and other contaminants.

Auto-Set™ Elite can be used on multiple materials and multiple processes with the ability to fine-tune your settings. Easy to set up and use!

Excellent arc characteristics! Positive arc starts and an extremely stable arc with minimal spatter.

Auto Spool Gun Detect™ automatically detects when a MIG gun or spool gun is connected, eliminating the need for a switch.

Multimatic 215 model additional features

Intuitive color LCD interface makes it quick and easy to adjust parameters.

Angled cast-aluminum drive system provides smooth feeding and the ability to use 10-, 12- or 15-foot guns.



Light industrial 

Processes

- MIG (GMAW) ▪ Flux-cored (FCAW)
- DC stick (SMAW) ▪ DC TIG (DC GTAW)

Comes complete with

- 10 ft. (3 m) 250-amp MDX™-250 MIG gun (Multimatic 200) **OR** 10 ft. (3 m) 100-amp MDX™-100 MIG gun (Multimatic 215)
- 13 ft. (4 m) cable with electrode holder and 25 mm Dinse-style connector
- 10 ft. (3 m) work cable with clamp and 25 mm Dinse-style connector
- Power cord with MVP plugs for 120 V and 240 V
- Quick Select™ drive roll for .024 in. (0.6 mm) or .030/.035 in. (0.8/0.9 mm) solid wire, and .030/.035 in. (0.8/0.9 mm) flux-cored wire



- Flow gauge regulator and gas hose for argon or AR/CO₂ mix, extra MDX contact tips, information/settings chart and material thickness gauge (229895) – Hobart® spool of .030 in. solid wire and hook-and-loop cord wraps as seen in photo above are included with Multimatic 215 model only

Most popular accessories

- Spoolmate™ Spool Guns (pg 27) 300371 Spoolmate 100 301272 Spoolmate 150
- Running Gear/Cylinder Rack 301239 (pg 114)
- Protective Cover 301262 (pg 117) (for Multimatic 215 only)
- TIG Contractor Kits (pg 120) 301287 For Multimatic 200 301337 For Multimatic 215

Visit MillerWelds.com or your distributor for other Miller® options and accessories.

Model/Stock Number	Welding Mode/Process	Input Power	Amperage Range	Rated Output	Amps Input at Rated Output, 50/60 Hz				Wire Feed Speed	Max. Open-Circuit Voltage	Dimensions	Net Weight
					120 V	230 V/240 V	KVA	KW				
Multimatic 200 (907518) (951649) with TIG contractor kit (see page 120 for kit contents)	CV: MIG/flux-cored	120 V	30-140	90 A at 18.5 V, 60% duty cycle	18.0	–	2.2	2.0	70-425 ipm (1.8-10.8 m/min.)	90 VDC	H: 14.5 in. (368 mm) W: 9.75 in. (248 mm) D: 17 in. (432 mm)	29 lb. (13.2 kg)
				110 A at 19.5 V, 20% duty cycle	22.4	–	2.7	2.6				
	230 V	30-200	150 A at 21.5 V, 20% duty cycle	–	17.5	4.0	3.8					
			CC: TIG	120 V	5-150	150 A at 16 V, 30% duty cycle	27.0	–	3.3	3.2		
	230 V	5-150	150 A at 16 V, 30% duty cycle	–	13.8	3.2	3.0					
	CC: Stick	120 V	20-100	100 A at 24 V, 35% duty cycle	24.0	–	2.9	2.8				
230 V		20-150	150 A at 26 V, 30% duty cycle	–	20.8	4.8	4.5					
Multimatic 215 (907693) (951674) with TIG contractor kit (see page 120 for kit contents)	CV: MIG/flux-cored	120 V	30-125	110 A at 19.5 V, 60% duty cycle	23.0	–	2.8	2.8	60-600 ipm (1.5-15.2 m/min.)	58 VDC	H: 12.5 in. (318 mm) W: 11.25 in. (286 mm) D: 20.5 in. (521 mm)	38 lb. (17.2 kg)
				200 A at 24 V, 20% duty cycle	–	25.8	6.2	6.2				
				150 A at 21.5 V, 40% duty cycle	–	16.7	4.0	4.0				
	CC: TIG	120 V	20-150	140 A at 15.6 V, 40% duty cycle	24.6	–	3.0	3.0	–	58 VDC		
		240 V	20-210	190 A at 17.6 V, 20% duty cycle	–	18.0	6.7	6.7				
	CC: Stick	120 V	30-100	90 A at 23.6 V, 40% duty cycle	22.7	–	2.7	2.7				
240 V		30-200	190 A at 27.6 V, 20% duty cycle	–	27.0	6.5	6.5					



Multimatic® 220 AC/DC

See literature DC/12.65



Multi-voltage plug (MVP™) allows connection to common 120- and 240-volt power receptacles without the use of any tools – simply choose the plug that fits the receptacle and connect to the power cord.



See page 121

Welding Capability

Max. 3/8 in. (9.5 mm)	Max. 3/8 in. (9.5 mm)
MIG Mild Steel	MIG Aluminum
Min. 24 ga. (0.6 mm)	Min. 18 ga. (1.2 mm)
Max. 1/4 in. (6.4 mm)	Max. 1/4 in. (6.4 mm)
TIG Mild Steel	TIG Aluminum
Min. 24 ga. (0.6 mm)	Min. 24 ga. (0.6 mm)
Max. 3/8 in. (9.5 mm)	
Stick Mild Steel	
Min. 16 ga. (1.5 mm)	

MIG aluminum welding uses optional Spoolmate 100 and 4000 series aluminum wire OR Spoolmate 150 and either 4000 or 5000 series aluminum wire.

All in one. Comes equipped with all accessories to MIG, stick, AC and DC TIG weld with one machine – unlike other machines where you need to purchase additional accessories.

Innovative QuickTech™ technology makes setup and changing processes even easier.

- Automatically determines the polarity. Work is always connected to the bottom right receptacle. MIG gun and TIG torch can stay connected at the same time.
- Automatically switches to the right process. Just hit the trigger or the foot control and the machine automatically changes, eliminating the need to manually change processes.
- Automatically recalls the settings from the last process used.

Auto-Set™ Elite can be used on multiple materials and multiple processes with the ability to fine-tune your settings. Easy to set up and use!

Pro-Set™ (TIG/stick) eliminates the guesswork when setting weld parameters. Use Pro-Set when you want the speed, convenience and confidence of preset controls.

Intuitive color LCD interface makes it quick and easy to adjust parameters.

Weighing only 56 pounds, this lightweight MIG, stick and AC/DC TIG welder provides portability on the job.

Two shielding gas connections (one for MIG gas and one for TIG gas) so both gases can be left connected to the machine – no switching needed.

Manual mode offers additional TIG adjustments for increased control including AC balance, AC frequency and DC pulsing.

TIG high-frequency (HF) arc starting for non-contact arc initiation, reducing tungsten and material contamination.



Light Industrial ● CC CV AC DC 1 Phase

Processes

- MIG (GMAW) = Flux-cored (FCAW)
- DC stick (SMAW) = AC/DC TIG (GTAW)
- Pulsed TIG (GTAW-P)

Comes complete with

- 10 ft. (3 m) 100-amp MDX™-100 MIG gun
- 13 ft. (4 m) cable with electrode holder and 25 mm Dinse-style connector
- 12.5 ft. (3.8 m) Weldcraft™ A-150 (WP-17) TIG torch with 25 mm Dinse-style connector
- 10 ft. (3 m) work cable with clamp and 25 mm Dinse-style connector
- 6.5 ft. (2 m) power cord with MVP plugs for 120 V and 240 V
- RFC5-14 HD foot control with 20 ft. (6 m) cord
- Quick Select™ drive roll for .024 in. (0.6 mm) or .030/.035 in. (0.8/0.9 mm) solid wire, and .030/.035 in. (0.8/0.9 mm) flux-cored wire
- Two flow gauge regulators and gas hoses for argon or AR/CO₂ mix, extra contact tips, Hobart® spool of .030 in. solid wire, AK2C TIG torch accessory kit, hook-and-loop cord wraps and material thickness gauge (229895)

Most popular accessories

- Spoolmate™ Spool Guns (pg 27)
 - 300371 Spoolmate 100
 - 301272 Spoolmate 150



- Dual Cylinder Rack Cart 951770 (pg 114)
- Protective Cover 301524 (pg 117)
- Wireless Remote Foot Control 300429 (pg 121)

Visit MillerWelds.com or your distributor for other Miller® options and accessories.

Stock Number (907757)	Welding Mode/Process	Input Power	Amperage Range	Rated Output	Amps Input at Rated Output, 50/60 Hz				Wire Feed Speed	Max. Open-Circuit Voltage	Dimensions	Net Weight
					120 V	240 V	KVA	KW				
CV: MIG/flux-cored		120 V	30-125	105 A at 19.2 V, 60% duty cycle	23.3	–	2.8	2.8	60-600 ipm (1.5-15.2 m/min.)	45 VDC	H: 17.5 in. (445 mm) W: 11.25 in. (286 mm) D: 21.5 in. (546 mm)	56 lb. (25.3 kg)
				200 A at 24 V, 20% duty cycle	–	27.2	4.8	4.8				
				170 A at 21.5 V, 40% duty cycle	–	21.5	3.8	3.8				
CC: TIG		120 V	20-140	130 A at 15.2 V, 40% duty cycle	24.0	–	2.9	2.9	–	46 VDC		
				240 V	20-210	210 A at 18.4 V, 20% duty cycle	–	22.4				
CC: Stick		120 V	30-90	90 A at 23.6 V, 40% duty cycle	24.5	–	2.9	2.9				
				240 V	30-200	200 A at 28.4 V, 15% duty cycle	–	31.3				

Multimatic® 255

See literature DC/12.9



Multimatic 255 with running gear package shown.



See page 121

Welding Capability

Max. 1/2 in. (13 mm)	Max. 1/2 in. (13 mm)
Mild Steel	Aluminum
Min. 22 ga. (0.8 mm)	Min. 18 ga. (1.2 mm)
Max. 3/8 in. (9.5 mm)	Max. 5/16 in. (7.9 mm)
TIG Mild Steel	Stick Mild Steel
Min. 24 ga. (0.6 mm)	Min. 16 ga. (1.5 mm)

Aluminum welding uses optional XR-Aluma-Pro push-pull gun. TIG welding uses optional Multimatic 255 TIG kit.



Easy-to-understand interface with 7-inch color LCD display ensures proper machine setup and parameter selection, reducing setup time and increasing weld time.

- Quick-access process and weld mode backlit buttons across the top illuminate when active
- Soft-key buttons below the display change function depending on which screen is displayed – makes setup or change quick, easy and intuitive
- Large text for easier readability
- Intuitive connection setup images
- Full troubleshooting descriptions versus help errors and look up codes

AUTO-LINE TECHNOLOGY Allows for any input voltage hookup (208–575 V, single-phase) with no manual linking, providing convenience in any job setting. Ideal solution for dirty or unreliable power.

Auto-Set™ Elite offers predefined weld settings to increase ease of use and ensure that the job is done right for operators of all skill levels.

- Available for MIG, pulsed MIG, stick and DC TIG processes with the ability to fine-tune your settings
- Set weld parameters by:
 - MIG – selecting wire and gas type, wire diameter and material thickness
 - Stick – selecting electrode type, electrode diameter and material thickness
 - DC Lift-Arc™ TIG – selecting remote on/off, tungsten diameter and material thickness

Built-in pulsed MIG programs. All programmed information is restored after each power up – aluminum/steel/stainless steel.

Program mode allows easy save and recall of favorite weld settings. Save up to four programs for each process. Delivers more productivity and consistent quality while minimizing supervisor intervention.

EXCLUSIVE! Auto-Gun Detect™ automatically adjusts voltage, wire speed and timers for faster switching between MIG, push-pull and spool guns.

Heavy-duty aluminum two-drive-roll system.

Fan-On-Demand™ cooling system only operates when needed, reducing power consumption and keeping internal components cleaner.

Industrial ● CC CV DC 1 Phase

Processes

- MIG (GMAW) ▪ Flux-cored (FCAW)
- Pulsed MIG (GMAW-P)
- DC stick (SMAW)
- DC Lift-Arc™ TIG (GTAW)
- Pulsed TIG (GTAW-P)

Multimatic 255

comes complete with

- 15 ft. (4.5 m) 250-amp MDX™-250 MIG gun with Bernard® AccuLock™ S consumables
- 10 ft. (3 m) cable with electrode holder
- 10 ft. (3 m) work cable with clamp
- 10 ft. (3 m) industrial power cord
- Factory-installed gas solenoid
- Flow gauge regulator and gas hose for argon or AR/CO₂ mix
- Chain to secure gas cylinder
- .035/.045 in. reversible V-groove drive rolls
- Extra contact tips and material thickness gauge (229895)

Most popular accessories

- MDX™-250 EZ-Select™ MIG Gun 1770047 (pg 24)
 - Spoolmatic® Spool Gun (pg 28) (non-Pro gun only)
 - XR-Aluma-Pro™ Air-Cooled Push-Pull Guns (pg 29)
 - EZ-Latch™ Single Cylinder Running Gear 301449 (pg 114)
 - EZ-Latch™ Dual Cylinder Rack with Elevated Gun and Cable Rack 301481
- Converts an EZ-Latch™ Single Cylinder Running Gear into a Dual Cylinder Rack Running Gear as seen below



- EZ-Latch™ Dual Cylinder Running Gear 951769 (pg 114)
- Protective Cover 301521 (pg 117)
- Multimatic 255 TIG Kit 301518 (pg 120)
- 10-Pin to 14-Pin Adapter Cord 301545 (pg 120)
- Wireless Remote Foot Control 300429 (pg 121)

Visit MillerWelds.com or your distributor for other Miller® options and accessories.

Stock Number	Welding Mode/Process	Amperage Range	Rated Output	Amps Input at Rated Output, 50/60 Hz	Wire Feed Speed	Max. Open-Circuit Voltage	Power Source Dimensions	Power Source Net Weight
(907728) 208–575 V	CV: MIG/flux-cored CC: Stick CC: DC TIG	20–350	230 A at 25.5 V, 60% duty cycle	208 V	50–800 ipm (1.3–20 m/min.)	81 VDC	H: 19.24 in. (489 mm) W: 13.75 in. (349 mm) D: 26.25 in. (667 mm)	84 lb. (38 kg)
240 V								
460 V								
(951767) 208–575 V with single cylinder running gear				240 V				
(951768) 208–575 V with dual cylinder running gear and TIG kit				460 V				
				575 V				
				KVA				
				KW				



NEW! Maxstar 280 Multiprocess Dynasty® 280 DX Multiprocess

See literature DC/35.5 (Maxstar) and AD/4.95 (Dynasty)

Multiprocess performance in a portable package. Designed for industrial applications that require a versatile solution with superior arc performance.



See page 121

Maxstar 280 Multiprocess (far left) and Dynasty 280 DX Multiprocess shown with ArcReach SuitCase 8 (packages now available for Dynasty with ArcReach SuitCase, see below).

AUTO-LINE TECHNOLOGY Allows for any input voltage hook-up (208–575 V) with no manual linking, providing convenience in any job setting. Ideal solution for dirty or unreliable power.

Blue Lightning™ high-frequency (HF) arc starter for non-contact arc initiation. Provides more consistent arc starts and greater reliability compared to traditional HF arc starters.

Pulsed TIG can be used to increase puddle agitation, arc stability and travel speeds while reducing heat input and distortion.

Fan-On-Demand™ cooling system only operates when needed, reducing power consumption and keeping internal components cleaner.

Cooler-On-Demand™ feature operates the auxiliary cooling system only when needed. Reduces noise, energy use, and airborne contaminants pulled through the cooler.

ArcReach SuitCase feeder paired with the CV output of the Maxstar or Dynasty power source gives this unit MIG process capabilities.

Note: Maxstar and Dynasty are not capable of ArcReach control.



Dynasty 280 DX Multiprocess Complete package shown.

Industrial ● AC/DC 3 1 DC Phase Phase

Processes

- AC/DC TIG (GTAW) ■ Pulsed TIG (GTAW-P)
- MIG (GMAW)² ■ Flux-cored (FCAW)²
- Stick (SMAW) ■ Air carbon arc (CAC-A)

¹Dynasty model only.

²With ArcReach SuitCase wire feeder.

Comes with

- 8 ft. (2.4 m) power cord (no plug)
- Two 50 mm Dinse-style connectors
- Two Dinse/Tweco® adapters
- 8 ft. (2.4 m) weld cable with Tweco®-style connectors to power feeder
- Quick reference guide

Contractor packages include above, plus

- Contractor kit with A-200 TIG torch and RCCS-14 fingertip control (301550) **OR** RFCS-14 HD foot control (301549)
- ArcReach® SuitCase® 8 **OR** ArcReach® SuitCase® 12 with two .035/.045 in. “V” groove drive rolls
- Bernard® BTB Gun 300 A with three .035 in. and two .045 in. Centerfire™ contact tips

Complete package includes ArcReach SuitCase 12 and Bernard BTB gun from package above, plus

- Coolmate™ 1.3
- Coolant (4 one-gallon bottles)
- Small Runner™ cart
- Wireless foot control
- Weldcraft™ W-280 water-cooled torch kit

Most popular accessories

- ArcReach® SuitCase® Feeders (pg 18)
- Small Runner™ Cart 301318 (pg 115)
- Coolmate™ 1.3 300972 (pg 115)
- Contractor Kits (pg 120)
 - 301311 w/RCCS-14 finger control
 - 301309 w/RFCS-14 HD foot control
- Weldcraft™ Water-Cooled Torch Kits (pg 120)
 - 300185 W-250 (WP-20)
 - 300990 W-280 (WP-280)
 - 301268 W-375
- Remote Controls (pg 120–121)

Visit MillerWelds.com or your distributor for other Miller® options and accessories.

*Refer to owner's manual for complete ratings.
**Sense voltage for low OCV stick and Lift-Arc™ TIG.

	Model/Stock Number	Welding Process	Input Power	Welding Amp Range	Rated Output at 60% Duty Cycle	Amps Input at Rated Load Output, 50/60 Hz					Max. Open-Circuit Voltage	Power Source Dimensions	Power Source Net Weight		
					208 V	230 V	400 V	460 V	575 V	KVA	KW				
DC Maxstar	Maxstar 280 Multiprocess (907552001) Power source only	TIG	3-phase	1-280	250 A at 20 V	21	19	11	9	7	7.6	7.3	60 VDC (11 VDC**)	H: 13.6 in. (346 mm) W: 8.6 in. (219 mm) D: 22.5 in. (569 mm)	47 lb. (21.3 kg)
			1-phase	1-280	250 A at 20 V	35	32	18	16	13	7.3	7.1			
		Stick	3-phase	5-280	250 A at 30 V	*	*	14	13	10	9.9	9.6			
			1-phase	5-280	180 A at 27.2 V	32	29	*	*	*	6.7	6.5			
AC/DC Dynasty	Dynasty 280 DX Multiprocess (907514007) Power source only (951796) Contractor w/fingertip and SuitCase 8 (951798) Contractor w/fingertip and SuitCase 12 (951797) Contractor w/foot and SuitCase 8 (951799) Contractor w/foot and SuitCase 12 (951757) Complete w/wireless foot and SuitCase 12	TIG	3-phase	2-280 (AC) 1-280 (DC)	250 A at 20 V	21	19	11	9	7	7.6	7.3	60 VDC (11 VDC**)	H: 13.6 in. (346 mm) W: 8.6 in. (219 mm) D: 22.5 in. (569 mm)	55 lb. (25 kg)
			1-phase	2-280 (AC) 1-280 (DC)	250 A at 20 V	35	32	18	16	13	7.3	7.1			
		Stick	3-phase	5-280	250 A at 30 V	*	*	14	13	10	9.9	9.6			
			1-phase	5-280	180 A at 27.2 V	32	29	*	*	*	6.7	6.5			
MIG/ flux-cored	3-phase	5-280	250 A at 26.5 V	*	*	13	11	9	9.2	8.9					
	1-phase	5-280	200 A at 24 V	31	29	*	*	*	6.5	6.3					

Dimension™ 650 and 650 ArcReach®

See literature DC/19.3

Developed for harsh environmental conditions and output requirements that range from power-intensive to precise.



Dimension 650 ArcReach power source shown with ArcReach SuitCase 12 feeder and ArcReach Stick/TIG Remote (all sold separately). Feeder includes Bernard BTB Gun 300 A OR S-Gun™ with reversible dual size (.045 and 1/16 in.) VK drive rolls.

ArcReach®

Every year, outdated welding equipment wastes hundreds of productive work hours — and thousands of dollars in profit — by forcing operators to make numerous walks from the weld joint to the welder. Welding systems with ArcReach technology let operators adjust welding parameters right at the weld joint without a control cord using the wire feeder or remote — maximizing arc-on time, improving safety and impacting the bottom line. See pages 18/46 for ArcReach SuitCase feeders and page 46 for the Stick/TIG Remote. **Don't walk. Weld!** Learn more at MillerWelds.com/arcreach

Note: Dimension 650 ArcReach does not support the new Cable Length Compensation (CLC™) and Adjust While Welding (AWW™) features or the ArcReach Smart Feeder.

All aluminum construction helps the machine resist corrosion for long life.

Exclusive protection input inductor protects machine's performance and reliability from "dirty" input power.

Wind Tunnel Technology™ Internal air flow that protects components, greatly improving reliability.

Fan-On-Demand™ cooling system only operates when needed, reducing power consumption and keeping internal components cleaner.

High-quality performance in all welding processes, from thick to thin metals.

Arc control available in the stick and wire modes for easier fine tuning of tough-to-weld materials and out-of-position applications.

Reduced size and weight results in an easier-to-handle package that exceeds the welding performance of larger, heavier machines. Dimension 650 is 3.5 times lighter than the Dimension 652 and also uses 40 percent less floor space.

High electrical efficiency and excellent power factor mean that you can get more welding done using less power. Dimension 650 uses up to 32 percent less amperage than the Dimension 652.

Heavy industrial   

Processes

- MIG (GMAW) ▪ Flux-cored (FCAW)
- Stick (SMAW) ▪ TIG (GTAW)
- Submerged arc (SAW)
- Air carbon arc cutting and gouging (CAC-A) (rated 3/8 in. carbons)

Dimension 650 Stationary package includes

- Power source
- S-74 MPa Plus feeder with Bernard® BTB Gun 400 A and .035/.045 in. drive rolls
- Industrial MIG 4/0 kit consisting of flowmeter regulator with 10 ft. (3 m) gas hose, 10 ft. (3 m) 4/0 feeder weld cable with lugs, and 15 ft. (4.6 m) work cable with 600-amp C-clamp

Dimension 650 MIGRunner™ package includes above plus

- Running gear cylinder rack

Most popular accessories



▪ Dimension 650 ArcReach® Rack 907701

- Comes assembled with four Dimension 650 ArcReach power sources fused for 460 volts
- ArcReach® SuitCase® Feeders (pg 18/46)
- 70 Series Feeders (pg 20)
- Bernard® MIG Guns (pg 25-26)
- ArcReach® Stick/TIG Remote 301325 (pg 46) (for ArcReach model only)
- Running Gear Cylinder Rack 300408 (pg 115)
- Industrial MIG 4/0 Kit (with lug connectors) 300390 (pg 117)
- Extension Cables (pg 122)
 - 242208025 25 ft. (7.6 m)
 - 242208050 50 ft. (15 m)
 - 242208080 80 ft. (24.4 m)

Visit MillerWelds.com or your distributor for other Miller® options and accessories.

Model/Stock Number	Amperage/ Voltage Ranges	Rated Output	Amps Input at Rated Output, 50/60 Hz				Max. Open-Circuit Voltage	Power Source Dimensions (Includes lift eye)	Power Source Net Weight
			380 V	460 V	KVA	KW			
Dimension 650 (907617) 380/460 V power source only (951638) 380/460 V stationary package (951637) 380/460 V MIGRunner package	CC mode: 10-815 A CV mode: 10-44 V SAW mode: 10-65 V	650 A at 44 VDC, 100% duty cycle	53.2	42.8	34	30.7	87 VDC	H: 28.187 in. (716 mm) W: 16.687 in. (424 mm) D: 31.625 in. (803 mm)	158 lb. (71.7 kg)
Dimension 650 ArcReach (907617001) 380/460 V power source only									



XMT® Series

Portability and excellent multiprocess arc performance make the XMT family the most popular in the industry. With many models to choose from the XMT family has the right solution for your business.



Input power choices

AUTO-LINE TECHNOLOGY XMT 350 models allow for any input voltage hookup (208–575 V, single- or three-phase) with no manual linking, providing convenience in any job setting. Ideal solution for dirty or unreliable input power.

Standard hookup on XMT 450 models. 230/460 V manual link or 575 V, three-phase only.

Advanced features for the professional welder

Adaptive Hot Start™ makes starting stick electrodes easy without creating an inclusion.

Infinite arc control available in the stick and wire modes for easier fine tuning of tough-to-weld materials and out-of-position applications.

Lift-Arc™ provides arc starting that minimizes contamination of the electrode and without the use of high frequency.

Insight Core™ **Welding Intelligence™ system.** XMT 14-pin models are Insight Core capable to monitor weld voltage, amperage, and arc-time and percentage.

Reliability

Wind Tunnel Technology™ Internal air flow that protects components, greatly improving reliability.

Fan-On-Demand™ cooling system only operates when needed, reducing power consumption and keeping internal components cleaner.

Welder-friendly control panel

Process selector switch reduces the number of control setup combinations without reducing any features.

Ultra-tough, polycarbonate-blended cover protects front controls from damage.

Large, dual digital meters are easy to view and presettable to ease setting weld output.

Output connector choices

Dinse- or Tweco®-style weld disconnects (350 models) provide high-quality weld cable connections.

Note: Two Dinse connectors are supplied with Dinse machines. Tweco connectors must be ordered separately.

Weld studs (450 models).

14-pin receptacle provides a quick, direct connection to Miller® wire feeders. Capable of remote voltage control.

Choose the Right XMT

	350 Amp		450 Amp	
	XMT 350 CC/CV	XMT 350 MPa	XMT 450 CC/CV	XMT 450 MPa
Input Power	3- or 1-phase power		3-phase	
Primary Operating Range	Auto-Line (208–575 V)		Manual link (230/460 V) or 575 V	
Weld Output	350 A at 34 VDC (3-phase input power at 60% duty cycle)	UPGRADE	450 A at 38 VDC (3-phase input power at 100% duty cycle)	
Carbon Arc Gouging	Rated: 1/4 in. (6.4 mm)	UPGRADE	Rated: 5/16 in. (7.9 mm)	
Net Weight	80 lb. (36.3 kg)		122 lb. (55.3 kg)	
Output Connector	Dinse-style	Dinse- or Tweco-style	1/2 in. stud	
Pulsed MIG	–	UPGRADE Yes	–	UPGRADE Yes
14-pin Compliant	Yes		Yes	
Insight Core Capable (requires Insight Core 14-pin module)	Yes (page 68)		Yes (page 68)	
ArcReach™	Factory option (page 44)	–	Factory option (page 45)	–

XMT® 350 CC/CV and 450 CC/CV

See literature DC/18.93 (350) and DC/18.94 (450)

Flexibility and simplicity make this the most popular model. It has the core multiprocess capabilities along with the flexibility of a 14-pin for spool guns, feeders, and remote controls.



XMT® 350 MPa and 450 MPa

See literature DC/18.93 (350) and DC/18.94 (450)

Built-in pulse programs for manufacturing and fabrication applications that have benefits for standard steels, high-strength steels and aluminum.

Pulse programs provide a reduced heat-affected zone and good gap filling ability, and are great for thick to thin metal. They allow welding in all positions, as well as faster travel speeds and deposition.

SharpArc® controls the arc in pulsed MIG mode and gives total control over the arc cone shape, puddle fluidity and bead profile.

Additional features when using a 70 Series MPa Plus feeder or XR-AlumaFeed® feeder.

Synergic pulsed MIG.

As wire speed increases/decreases, pulse parameters also increase/decrease to match the right amount of power needed, eliminating the need to make additional adjustments.



Profile Pulse™ provides TIG appearance with MIG simplicity and productivity.

Achieve “stacked dimes” without gun manipulation. Profile Pulse frequency can be changed to increase or decrease the spacing between the ripple pattern to achieve the desired weld appearance.



Added capabilities with Insight Core.™ When using an MPa Plus feeder, wire deposition is added to the Insight Core capabilities.

Heavy industrial  XMT 450
Phase Phase is 3-phase only.

Processes

- MIG (GMAW) ▪ Pulsed MIG (GMAW-P)*
- Stick (SMAW) ▪ TIG (GTAW)
- Flux-cored (FCAW)
- Air carbon arc cutting and gouging (CAC-A) (carbons – 350: 1/4 in., 450: 5/16 in.)

*XMT MPa models only.

Most popular accessories

- XR-AlumaFeed® SuitCase® 301567 (pg 11)
- SuitCase® Feeders (pg 18)
- 20 and 70 Series Feeders (pg 20)
- Spoolmatic® WC-24 (pg 28/122)
- MIGRunner™ Cart 195445 (pg 115)
- Running Gear Cylinder Rack 300408 (pg 115)
- Coolmate™ Coolant System (pg 115)
- Industrial MIG 4/0 Kits (pg 117)
 - 300405 For XMT 350
 - 300390 For XMT 450
- Gas Valve Kit
 - See literature DC/18.93 (350) and DC/18.94 (450)

Visit MillerWelds.com or your distributor for other Miller® options and accessories.

¹ Optional 115-volt auxiliary power provides 10 amps of circuit-breaker protected power for coolant systems, etc.

² Feeders include gun and drive rolls. MIGRunner adds 2/0 weld cable and 2/0 work cable with clamp, flowmeter regulator with gas hose and MIGRunner cart.

³ Duty cycle rating below achieved with 6-gauge input power cord (8-gauge cord supplied with unit).

	Model/Stock Number Most Popular Models ◀	Input Power	Amperage/ Voltage Ranges	Rated Output	Amps Input at Rated Load Output, 60 Hz	Max. Open-Circuit Voltage	Power Source Dimensions	Power Source Net Weight
					208 V 230 V 400 V 460 V 575 V KVA KW			
350 A	XMT 350 CC/CV (Dinse) (907161) ◀ 208-575 V power source only (907161011) 208-575 V w/auxiliary power ¹ (951786) 208-575 V MIGRunner w/20 Series Basic ² (951314) 208-575 V MIGRunner w/S-74D ²	3-phase	5-425 A 10-38 V	350 A at 34 VDC, 60% duty cycle	40.4 36.1 20.6 17.8 14.1 14.2 13.6	75 VDC	H: 17 in. (432 mm) W: 12.5 in. (318 mm) D: 24 in. (610 mm)	80 lb. (36.3 kg)
	XMT 350 MPa (Dinse except where noted) (907366) ◀ 208-575 V power source only (907366011) 208-575 V w/auxiliary power ¹ (907366014) 208-575 V w/Tweco®	1-phase	5-425 A 10-38 V	300 A at 32 VDC, 60% duty cycle ³	60.8 54.6 29.7 24.5 19.9 11.7 11.2			
450 A	XMT 450 CC/CV (1/2 in. stud) (907481) ◀ 230/460 V power source only (907482) 575 V w/ArcReach	3-phase	15-600 A 10-38 V	450 A at 38 VDC, 100% duty cycle	— 51 — 27.6 24.4 22 18.9	90 VDC	H: 17.25 in. (438 mm) W: 14.5 in. (368 mm) D: 27.125 in. (689 mm)	122 lb. (55.3 kg)
	XMT 450 MPa (1/2 in. stud) (907479) ◀ 230/460 V power source only (907479001) 230/460 V w/auxiliary power ¹ (907480) 575 V power source only				— 51 — 27.6 23.6 21.6 18.3 (KVA is 23.5 on 575 V)			



XMT® 350 FieldPro™ Systems

See literature DC/18.96



Top row left to right: ArcReach SuitCase 12 feeder, XMT 350 FieldPro power source, XMT 350 FieldPro with Polarity Reversing power source, and ArcReach Smart Feeder. Bottom row left to right: ArcReach Stick/TIG Remote and ArcReach Stick/TIG Remote with Polarity Reversing. Feeders include gun and drive rolls (see page 18 for details).

ArcReach®

Every year, outdated welding equipment wastes hundreds of productive work hours – and thousands of dollars in profit – by forcing operators to make numerous walks from the weld joint to the welder. Welding systems with ArcReach technology let operators adjust welding parameters right at the weld joint without a control cord using the wire feeder or remote – maximizing arc-on time, improving safety and impacting the bottom line. See page 18/46 for ArcReach feeders and page 46 for the Stick/TIG Remotes.

Don't walk. Weld! Learn more at MillerWelds.com/arcreach

More jobsite productivity and efficiency

Cable Length Compensation (CLC™) ensures that the voltage a weld operator sets is the voltage they get by automatically adjusting voltage based on weld cable length, even hundreds of feet away from the power source.

Polarity reversing models of power source and remote are ideal for pipe and module assembly where changing polarity happens frequently.

AUTO-LINE TECHNOLOGY For portability and reliability, Auto-Line allows for any input voltage hookup (208–575 V, single- or three-phase) with no manual linking, providing convenience in any job setting. Ideal solution for dirty or unreliable power.

Auto-Bind™ automatically establishes exclusive communication between the power source and the wire feeder, using the existing weld cables upon system power up.

Exceptional arc performance

Common weld failures can be minimized with stick stops that are specifically programmed to eliminate arc strikes outside of the heat-affected zone.

Regulated Metal Deposition (RMD®) and pulsed MIG are fully supported, enabling operators to use these advanced processes in the field for faster, more-efficient welds.

Increased uptime

Delivers the performance you need. XMT 350 FieldPro welders and ArcReach feeders and remotes have been extensively proven in the field.

Wind Tunnel Technology™ Internal air flow that protects electrical components and PC boards from dirt, dust, debris... greatly improving reliability.

Eliminate expenses related to maintaining or replacing easily damaged control cords because the weld cables are used to communicate weld parameters between the wire feeder and power source.

Improved jobsite safety

Decrease the chances of slip, trip or fall injuries because ArcReach technology allows weld operators to make parameter changes at the wire feeder or remote instead of having to travel through multistory and cluttered jobsites back to the power source.

Maximum fleet compatibility

Maximize fleet compatibility and get the benefits of ArcReach when you pair XMT 350 FieldPro welders and ArcReach feeders with other ArcReach compatible products.

More operator control

Weld operators can Adjust While Welding (AWW™) to change weld parameters while the arc is on.

Inadvertent parameter changes by other jobsite workers can be easily avoided because connecting an ArcReach accessory from the power source automatically locks out the power source's panel controls.

Return to a previous weld process faster because the power source is restored to its previous settings once the ArcReach accessory is removed.

Decrease the chance of an incorrect weld process being used because Auto-Process Select™ automatically sets the power source to the correct weld process based on the polarity applied to the weld accessory.

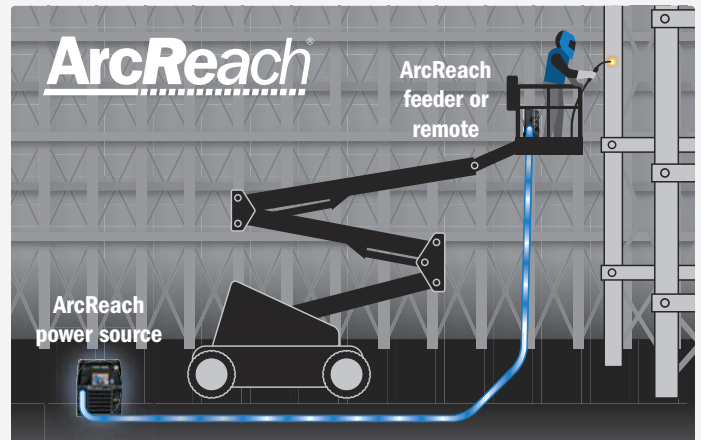

XMT® 450 CC/CV ArcReach®

See literature DC/18.94



Note: XMT 450 CC/CV ArcReach does not support the Cable Length Compensation (CLC™) and Adjust While Welding (AWW™) features or the ArcReach Smart Feeder.

Auto-Process Select.™ System automatically changes to MIG/FCAW (with gas) if electrode positive polarity is detected or FCAW (no gas) if electrode negative polarity is detected, when ArcReach communication is established between the feeder and the XMT – reducing the need to access the power supply.

Automatic return to panel settings. System automatically returns to XMT setting when ArcReach communication is terminated. For example, if the XMT is set to gouging at 550 amps and an ArcReach feeder is connected, the XMT will go to a MIG/FCAW process. If the feeder is disconnected, the XMT will go back to its previous setting (gouging at 550 amps).

Auto-Bind™ automatically establishes exclusive communication between the power source and the wire feeder, using the existing weld cables upon system power up.

Operator can precisely set arc voltage at the feeder and monitor the actual arc voltage and current delivered to the weld using the digital meters on the feeder. This removes guesswork when it comes to adhering to weld procedures.

Remote override of XMT. When an ArcReach feeder is connected to an XMT 450 ArcReach the feeder has full control and the XMT controls are disabled, preventing accidental changes by personnel other than the welding operator.

Heavy industrial ●
CC CV DC 3 1 XMT 450
 Phase Phase is 3-phase only.

Processes

- MIG (GMAW) ▪ Stick (SMAW)
- TIG (GTAW) ▪ Flux-cored (FCAW)
- RMD* ▪ Pulsed MIG (GMAW-P)*
- Air carbon arc cutting and gouging (CAC-A) (carbons – 304: 1/4 in., 350: 1/4 in., 450: 5/16 in.)

*XMT 350 FieldPro only with ArcReach Smart Feeder.

Stick/TIG system includes

- XMT 350 FieldPro power source
- ArcReach Stick/TIG Remote

MIG/flux-cored system includes

- XMT 350 FieldPro power source
- ArcReach SuitCase 12 feeder with drive rolls and Bernard® BTB Gun 300 A

RMD/pulse system includes

- XMT 350 FieldPro power source
- ArcReach Smart Feeder with drive rolls and Bernard® PipeWox 300-15 MIG gun

Most popular accessories

- XR-AlumaFeed® SuitCase® 301567 (pg 11)
- ArcReach® SuitCase® Feeders (pg 18/46)
- ArcReach® Smart Feeder (pg 18/46) (for XMT 350 FieldPro power sources only)
- 20 and 70 Series Feeders (pg 20)
- Spoolmatic®/WC-24 (pg 28/122)
- ArcReach® Stick/TIG Remote 301325 (pg 46)
- ArcReach® Stick/TIG Remote with Polarity Reversing 300934 (pg 46) (for XMT 350 FieldPro with Polarity Reversing power source only)

Visit MillerWelds.com or your distributor for other Miller® options and accessories.

XMT Racks

All the benefits of an individual XMT in an easy-to-transport package for multiple arcs in the field.



XMT 350 FieldPro Rack shown.

Flexible solution. The flexibility of the XMT makes it ideal for multiple system racks. Every system in a rack can be used for different tasks on-site, increasing fleet utilization and making the best use of equipment budgets.

Easy installation. The power distribution system on the rack allows the entire rack to be wired into a single power drop, isolating high-voltage power in the field.

Model	Stock Number	Input Power to Rack
XMT 350 FieldPro	4-Pack Rack (907739)	230-575 V, three-phase (fused for 460/575 V)
	6-Pack Rack (907740)	
XMT 350 FieldPro with Polarity Reversing	4-Pack Rack (907742)	230-575 V, three-phase (fused for 460/575 V)
	6-Pack Rack (907741)	
XMT 450 CC/CV ArcReach	4-Pack Rack (907700)	230/460 V, three-phase (fused for 460 V)

*Optional 115-volt auxiliary power provides 10 amps of circuit-breaker protected power for coolant systems, etc.

**Duty cycle rating below achieved with 6-gauge input power cord (8-gauge cord supplied with unit).

Model/Stock Number Most Popular Models	Input Power	Amperage/ Voltage Ranges	Rated Output	Amps Input at Rated Load Output, 60 Hz						Max. Open-Circuit Voltage	Dimensions	Net Weight		
				208 V	230 V	400 V	460 V	575 V	KVA	KW				
350 A	XMT 350 FieldPro System (Tweco®) (951736) Stick/TIG (951734) MIG/flux-cored (951738) RMD/pulse	3-phase	5-425 A 10-38 V	350 A at 34 VDC, 60% duty cycle	40.4	36.1	20.6	17.8	14.1	14.2	13.6	75 VDC	H: 17 in. (432 mm) W: 12.5 in. (318 mm) D: 24 in. (610 mm)	93 lb. (42.2 kg)
		1-phase	5-425 A 10-38 V	300 A at 32 VDC, 60% duty cycle**	60.8	54.6	29.7	24.5	19.9	11.7	11.2			
	XMT 350 FieldPro with Polarity Reversing System (Tweco®) (951737) Stick/TIG (951735) MIG/flux-cored (951739) RMD/pulse	3-phase	5-425 A 10-38 V	350 A at 34 VDC, 60% duty cycle	40.4	36.1	20.6	17.8	14.1	14.2	13.6	75 VDC	H: 17 in. (432 mm) W: 12.5 in. (318 mm) D: 24 in. (610 mm)	93 lb. (42.2 kg)
		1-phase	5-425 A 10-38 V	300 A at 32 VDC, 60% duty cycle**	60.8	54.6	29.7	24.5	19.9	11.7	11.2			
450 A	XMT 450 CC/CV ArcReach (1/2 in. stud) (907481003) 230/460 V (907481004) 230/460 V w/auxiliary power* (907482) 575 V	3-phase	15-600 A 10-38 V	450 A at 38 VDC, 100% duty cycle	–	51	–	27.6	24.4	22	18.9	90 VDC	H: 17.25 in. (438 mm) W: 14.5 in. (368 mm) D: 27.125 in. (689 mm)	122 lb. (55.3 kg)

DONT WALK WELD™

ArcReach WELDING SYSTEMS



The more they walk the more it costs.

“Business as usual” could cost you thousands of dollars a year and waste hundreds of hours of productive time. Welders can get more done — and your business can make more money — when you use **Miller® products with ArcReach® technology.**

Investing in ArcReach technology today can add up to big savings over time.



WHAT IT DOES:

With ArcReach technology, weld parameters can be adjusted remotely without a control cable. Parameter changes are sent to the power source through the weld leads.

HOW IT HELPS:

ArcReach technology saves welders multiple walks back and forth to the power source. That saves time, boosts productivity, and improves safety and weld quality.

ArcReach power sources and accessories



ARC REACH PLUG-IN POWER SOURCES

XMT® 350 FieldPro™ system pg 44

Exceptional arc performance maximizes weld quality, minimizes defects.

XMT® 350 FieldPro™ system with Polarity Reversing pg 44

Automatically selects polarity, lead outputs and weld parameters.

XMT® 450 CC/CV ArcReach®** pg 45

Portability and excellent arc performance with flexibility and simplicity.

Dimension™ 650 ArcReach®** pg 41

For harsh environments and a wide range of output requirements.

ARC REACH ENGINE-DRIVEN POWER SOURCES

Trailblazer® 325 ArcReach® models** pg 76

Smaller and lighter than competition with unbeatable arc performance.

Big Blue® ArcReach® models** pg 78–81

Tackle tough jobs that require high output for welding, gouging and aux power.

ARC REACH WIRE FEEDERS

ArcReach® SuitCase® Feeders pg 18

For all ArcReach power sources. For MIG and flux-cored welding. Features remote voltage control and Auto-Process Select™.

ArcReach® Smart Feeder pg 18

For both XMT 350 FieldPro models and all ArcReach engine drives. For RMD® and pulsed MIG welding up to 200 feet from the power source. Helps reduce weld failures and eliminate backing gas on some stainless and chrome-moly applications.

ARC REACH STICK/TIG REMOTES

ArcReach® Stick/TIG Remote 301325

For all ArcReach power sources except XMT 350 FieldPro with Polarity Reversing. Features remote amperage control, arc control for stick and Auto-Process Select.

ArcReach® Stick/TIG Remote with Polarity Reversing 300934

For XMT 350 FieldPro with Polarity Reversing power source only. Provides all the same functionality of the XMT 350 FieldPro with Polarity Reversing hundreds of feet from the power source, including process changeover and amperage adjustment — with no special cables.

*Does not support the new Cable Length Compensation (CLC) and Adjust While Welding (AWW) features or the ArcReach Smart Feeder.

**Does not support the new Cable Length Compensation (CLC) and Adjust While Welding (AWW) features.

PipeWorx 400 Welding System

See literature PWS/2.0

Optimized for pipe fabrication shops.

PipeWorx 400 welding system shown with PipeWorx accessory kit for dual-wire feeder. Filler metal and shielding gas sold separately.



Simple process setup

- The front panel was designed by welders for welders
- Requires just a few basic steps to set up a new weld process, resulting in less training time and minimizing errors from incorrect setups
- Memory feature stores four programs for each selection: stick, DC TIG, and MIG (left and right side of feeder) – eliminates the need to remember parameters

True multiprocess machine

- Weld processes are optimized to deliver superior arc performance and stability, specifically for root, fill, and cap passes on pipe
- RMD® and pulsed MIG increase quality and productivity

Quick process changeover

- Simply push a process selection button to choose a welding process
- Eliminates setup time and reduces the risk of weld reworks due to incorrect cable connections
- PipeWorx “Quick Select” technology automatically selects the welding process, the correct polarity, cable outputs, gas solenoid, and user-programmed welding parameters

Single-system design

- One machine designed to perform all of your pipe welding needs
- Simplified and optimized specifically for pipe welding

Heavy industrial 

Processes

- Stick (SMAW) ▪ DC TIG (GTAW)
- MIG (GMAW) ▪ Flux-cored (FCAW)
- RMD ▪ Pulsed MIG (GMAW-P)
- Air carbon arc cutting and gouging (CAC-A)

PipeWorx welding system comes complete with

- PipeWorx 400 power source with cable hangers (907382 OR 907384)
- Dual-wire feeder with drive rolls (300366)
- Two Bernard® PipeWorx 300-15 MIG guns (195400)
- Running gear with gas cylinder rack and handles (300368)
- Cable kit with 25 ft. (7.6 m) work sense lead (300367)

Most popular accessories

- Bernard® PipeWorx Guns
195399 15 ft. (4.6 m), 250-15
195400 15 ft. (4.6 m), 300-15
- PipeWorx Accessories Kit for Dual-wire Feeder 300568
Includes 25 ft. (7.6 m) work cable with EG500 clamp, two flowmeter regulators and two 5 ft. (1.5 m) gas hoses
- Composite Cable Kit
300454 25 ft. (7.6 m)
300456 50 ft. (15.2 m)
- PipeWorx Cooler 300370
- Foot Control Bracket 300676
- RFCS-14 HD 194744 (pg 120)
- RPBS-14 300666 (pg 120)

Visit MillerWelds.com or your distributor for other Miller® options and accessories.

Advanced Technologies of PipeWorx System

Regulated Metal Deposition (RMD®)

- Higher quality root pass
- Calm stable arc
- Less spatter
- More tolerant of hi-lo conditions
- Reduced training requirements
- Less chance of cold lap or lack of fusion; reduces rework
- Can eliminate the need for a hot pass
- Can eliminate backing/purge gas in some stainless applications



RMD carbon steel

Pulsed MIG

- Less heat input than traditional spray pulse transfer
- Shorter arc length
- Narrower arc cone
- Improved fusion and fill at the toes of the weld resulting in:
 - Faster travel speeds
 - Higher deposition rates
- Less training time required because pulsed MIG:
 - Virtually eliminates arc wander
 - Is easier to control the puddle
 - Compensates for tip-to-work variations automatically
- When used with RMD, it is possible to use one wire and one gas for all passes



Pulsed MIG stainless

*Dimensions and weight are for power source only.

Model/Stock Number Most Popular System 	Welding Mode/ Process	Amperage/ Voltage Ranges	Rated Output at 100% Duty Cycle	Amps Input at Rated Output, 60 Hz, 3-Phase			KVA			KW			Max. Open- Circuit Voltage	Dimensions*	Net Weight*
				230 V	460 V	575 V	230 V	460 V	575 V	230 V	460 V	575 V			
PipeWorx 400 Welding System (951381) 230/460 V (951382) 575 V PipeWorx 400 Power Source only (907382) 230/460 V (907384) 575 V	CC: Stick	40-400 A	400 A at 36 VDC	43.9	26.6	22.4	17.5	21.2	22.3	16.1	16.3	16.4	90 VDC	H: 28.5 in. (724 mm) W: 19.5 in. (495 mm) D: 31.75 in. (806 mm)	225 lb. (102 kg)
	CC/DC: TIG	10-350 A	350 A at 24 VDC	29.3	18.2	13.5	11.8	14.5	13.4	10.7	10.6	10			
	CV: MIG/flux-cored	10-44 V	400 A at 34 VDC	42.9	24	20.5	17.3	19.2	20.5	16	15.8	16.2			
Model/Stock Number	Input Power	Input Welding Circuit Rating	Wire Feed Speed	Wire Diameter Capacity			Maximum Spool Size Capacity			Dimensions			Net Weight		
PipeWorx Dual-wire Feeder only (300366)	24 VAC, 11 A	100 V, 750 A at 100% duty cycle	50-780 ipm (1.3-19.8 m/min.)	.035-.062 in. (0.9-1.6 mm)			60 lb. (27 kg)			H: 14 in. (356 mm) W: 19 in. (483 mm) D: 29 in. (737 mm)			90 lb. (41 kg)		



Product Guide

	Page	Class	Stick	DC TIG	CAC-A	Portability	Weldable Metals	Welding Amperage Range	Special Features	Typical Applications
1-Phase	Thunderbolt® 160	48	●	●		Handle, shoulder strap	Steel, stainless	20-160 DC	Infinite amperage control, dual-voltage MVP™ plugs	Garage/job shops, maintenance/repair, farm
	Thunderbolt® 210	48	●	●				25-210 DC	Infinite amperage control	Garage/job shops, maintenance/repair, farm
	Maxstar® 161 S	48	●	●		Handle/shoulder strap, optional case		20-160 DC	Auto-Line™ (120-240 V), digital meter	MRO, ship installation/repair, farm/ranch
1- & 3-Ph	Maxstar® 210 STR	49	●	●		Handles, shoulder strap, optional carts	Steel, stainless	5-210 DC	Auto-Line™ (120-480 V), digital meters	Construction, fabrication, pipe, steel erection, shipbuilding
	CST™ 280	50	●	●		Handle, optional cart		5-280 DC	Portable at 41 lb., optional meter, also available in multioperator rack	Construction, fabrication, pipe, steel erection, shipbuilding
3-Ph	CST™ 280 Rack	50	●	●	5/16"	Lift eye, optional running gear	Steel, stainless	5-280 DC	Up to 4 or 8 operators, lightweight	Construction, maintenance/repair, shipbuilding

Product Key

Class: ● Light industrial ● Industrial ● Heavy industrial Capability: ● Designed for this process ● Capable of this process
*Two machines paralleled.

Thunderbolt® 160 and 210

See literature DC/37.0

Dependable, portable, powerful stick welder.



Thunderbolt 160 shown.

Nearly 100 pounds lighter so you can work smarter not harder by bringing the welder to the work.

More powerful – up to 85 more amps – compared to leading competitive machine means you can weld thicker materials.

Hot Start™ technology provides easy, quick and reliable arc starts.



Thunderbolt 160 includes multi-voltage plug (MVP™)

which allows for connection to 120- or 240-volt receptacles without tools. Choose the plug that fits the receptacle and connect it to the power cord.

Light industrial ● CC DC 1 Phase

Process - Stick (SMAW)

Comes complete with

- 10 ft. (3 m) No. 4 electrode cable with heavy-duty electrode holder
- 10 ft. (3 m) work cable with clamp
- 6.5 ft. (2 m) power cord with MVP™ plugs for 120 V and 240 V (160 model) OR standard 240 V plug (210 model)
- Cable pouch

Visit MillerWelds.com or your distributor for Miller® options and accessories.

Model/Stock Number	Input Power	Welding Amperage Range	Rated Output	Amps Input at Rated Output	Max. Open-Circuit Voltage	Dimensions	Net Weight
Thunderbolt 160 (907721)	120 V	20-80	65 A at 20% duty cycle	20.7	91 VDC	H: 10.5 in. (267 mm) W: 7.125 in. (181 mm) D: 13.375 in. (340 mm)	15 lb. (6.8 kg)
	240 V	20-160	160 A at 30% duty cycle	27.8	91 VDC		
Thunderbolt 210 (907722)	240 V	25-210	210 A at 20% duty cycle	43.4	85 VDC		15.5 lb. (7.0 kg)

Maxstar® 161 S

See literature DC/27.3

Industrial class – provides maximum portability and performance in the most compact stick package in the industry.



Maxstar 161 S with X-CASE shown.



Allows for any input voltage hookup (120-240 V) with no manual linking, providing convenience in any job setting. Ideal solution for dirty or unreliable power.

Portable with adjustable handle/shoulder strap. Easy to transport at only 13 pounds.

Fan-On-Demand™ power source cooling system operates only when needed, reducing noise, energy use and the amount of contaminants pulled through the machine.

Digital meter for more precise control when presetting or monitoring welding amperage.

Adaptive Hot Start™ for stick arc starts.

Stick-Stuck detects if the electrode is stuck to the part and turns the welding output off to safely and easily remove the electrode. Menu selectable.

Superior stick arc performance even on the difficult-to-run electrodes like E6010.

Industrial ● CC DC 1 Phase

Process - Stick (SMAW)

Comes complete with

- 6.5 ft. (2 m) power cords for 120 V and 240 V
- 13 ft. (4 m) electrode cable with holder and 25 mm Dinse-style connector
- 10 ft. (3 m) work cable with clamp and 25 mm Dinse-style connector
- Quick-reference guide

907709001 includes above plus

- Protective X-CASE™

Most popular accessories

- Protective X-CASE™ 301429

Visit MillerWelds.com or your distributor for other Miller® options and accessories.

Stock Number	Input Power	Welding Amperage Range	Rated Output	Amps Input at Rated Output, 50/60 Hz	KVA at Duty Cycle	KW	Max. Open-Circuit Voltage	Dimensions	Net Weight
(907709) (907709001) with X-CASE	120 V	20-90	90 A at 23.6 V, 30% duty cycle	23.2	2.8	2.8	48 VDC (12-16 VDC*)	H: 10.3 in. (262 mm) W: 5.6 in. (142 mm) D: 13.5 in. (343 mm)	13 lb. (5.9 kg)
	240 V	20-160	160 A at 26.4 V, 20% duty cycle	22.6	5.4	5.3			

Maxstar® 210 STR See literature DC/32.1

Maximum flexibility with automatic connection to any input power while maintaining the best DC stick/TIG welding performance in its product class.



AUTO-LINE TECHNOLOGY Allows for any input voltage hookup (120–480 V) with no manual linking, providing convenience in any job setting. Ideal solution for dirty or unreliable power.

Lift-Arc™ provides TIG arc initiation without the use of high frequency.

Dual schedule allows operators to switch between welding parameters for specific electrodes without readjusting the machine.

Hot Start™ adaptive control provides positive arc starts without sticking.

Fan-On-Demand™ power source cooling system operates only when needed, reducing noise, energy use and the amount of contaminants pulled through the machine.

Remote amperage control.

Digital meters for more precise control when presetting or monitoring welding amperage.

Portable with adjustable shoulder strap.

Industrial ● **CC DC** **3 1**
Phase Phase

Processes

- Stick (SMAW) = TIG (GTAW)

Comes complete with

- 8 ft. (2.4 m) power cord (no plug)
- Two 50 mm Dinse-style connectors

Most popular accessories

- 12.5 ft. (3.8 m) Weldcraft™ A-150 Valve TIG torch WP-17V-25-2 (pg 60)
- Remote Controls (pg 120)
- Air-Cooled TIG Torch Connector (pg 121)

Visit MillerWelds.com or your distributor for other Miller® options and accessories.

Note: See page 54 in the TIG section for Maxstar 210 Series.
*Sense voltage for stick and Lift-Arc TIG.

Stock Number (907682)	Welding Process	Input Power	Welding Amperage Range	Rated Output	Phase	Amps Input at Rated Load Output, 50/60 Hz						Max. Open-Circuit Voltage	Dimensions	Net Weight	
						120 V	208 V	240 V	400 V	480 V	KVA				KW
	Stick	208-480 V	5-210	160 A at 26.4 V, 60% duty cycle	Three-phase	—	15	13	8	6	5.5	5.2	80 VDC (11 VDC*)	H: 13.6 in. (346 mm) W: 8.6 in. (219 mm) D: 19.5 in. (495 mm)	36 lb. (16.3 kg)
					Single-phase	—	26	22	13	11	5.3	5.3			
	TIG	208-480 V	1-210	210 A at 18.4 V, 60% duty cycle	Three-phase	—	14	12	7	6	5.2	4.9			
					Single-phase	—	24	20	12	10	4.9	4.9			
		120 V	5-100	90 A at 23.6 V, 60% duty cycle	Single-phase	23	—	—	—	—	2.8	2.8			
		120 V	1-210	125 A at 15 V, 60% duty cycle	Single-phase	22	—	—	—	—	2.6	2.6			

Get the Latest News from Miller®

Are you a professional fabricator, or do you like to repair everyday items in your home garage? Perhaps you're a welding educator looking for class resources or to share what your school has been working on?

Sign up for the Miller eNewsletters — **PRO**, **DIY**, **Instructor** and **The Bevel** — to receive new product updates, success stories, how-to and technical articles and videos, special offers, project ideas and other information tailored to your interests.

If you're an occupational health and safety professional, sign up for the **Welding Safety** eNewsletter to receive information on regulatory updates, industry news and solutions that can elevate productivity and compliance within the workplace.

Sign up now at MillerWelds.com/newsletters

Miller / PRO



MYTH vs. REALITY

Debunking 5 Common Misconceptions About Suitcase Wire Feeders

Are common wire feeder myths keeping you from reaping the benefits of wire welding processes on the jobsite? Learn the truth about feeder performance today.

Miller / DIY



PASSION TO PROFIT

How Josh Walton Started His Welding Business

There's nothing better than doing what you love every single day, which is why expert welder Josh Walton started his company, Brown Dog Welding. Get his advice for starting.

Miller / INSTRUCTOR



DEMAND FOR EDUCATION

Lewis and Clark Community College Relaunches Welding Technology Program

A new \$4.5 million welding education facility allowed Lewis and Clark Community College to double its welding bays and better meet student demand.

Miller / THE BEVEL



COMPETITIVE EDGE

NAES Power Contractors Saves Time and Money

NAES welders complete three times as many welds per shift by switching processes and polarity with the push of a button. See how they save time and avoid rework — with a record of less than five repairs on over 20,000 welds inspected.

CST™ 280

See literature DC/29.55

Durable power source designed for the construction industry. Ideal for stick electrodes up to 3/16-inch and TIG welding of pipe and plate.



Superior stick arc performance even on the difficult-to-run electrodes like E6010.

Simple voltage-changeover switch saves time when changing primary voltage. Input voltage can be changed without removal from inverter rack or removal of machine case.

Optional digital meter for more precise control when presetting or monitoring welding amperage.

Portable in the shop or at the jobsite – at 41 pounds (18.6 kg) the CST 280 is easily moved from location to location.

Lift-Arc™ start provides TIG arc starting without the use of high frequency.

Rack mountable for protection, storage and transportation of multiple power sources while using a single primary power cable.



See page 121

CST 280

CST 280 with meter

*Output on single-phase reduced to comply with current limitation on input cable.

Industrial ● **CC DC 3 1**
Phase Phase

Processes

- Stick (SMAW)
- TIG (GTAW)

Comes with

- 6 ft. (1.8 m) power cord
- One set of male connectors (Dinse-style model only)

Most popular accessories

- CST 280 Rack (see below)
- Remote Controls (pg 120-121)
- For TIG torches see literature DC/29.55

Visit MillerWelds.com or your distributor for other Miller® options and accessories.

Stock Number	Welding Process	Input Power	Welding Amperage Range	Rated Output	Amps Input at Rated Load Output, 50/60 Hz 208 V 220 V 230 V 400 V 440 V 460 V 575 V	KVA	KW	Max. Open-Circuit Voltage	Dimensions	Net Weight						
(907244) Dinse (907244011) Tweco® (907696) Tweco® with meter 220-230/460-575 V	Stick/TIG	Three-phase	5-280	280 A at 31.2 V, 35% duty cycle	—	35.0	34.2	—	—	17.8	14.7	14.6	10.2	77 VDC	H: 13.5 in. (343 mm) W: 7.5 in. (191 mm) D: 18 in. (457 mm)	41 lb. (18.6 kg)
			200 A at 28 V, 100% duty cycle	—	23.3	22.5	—	—	11.7	9.7	9.6	6.4				
		Single-phase	5-200	200 A at 28 V, 50% duty cycle*	—	43.9	43.0	—	—	—	—	10.1	6.6			
			150 A at 26 V, 100% duty cycle*	—	32.7	32.0	—	—	—	—	—	7.3	4.6			
(907251) Dinse (907251011) Tweco® (907563) Dinse with meter 208-230/400-460 V	Stick/TIG	Three-phase	5-280	280 A at 31.2 V, 35% duty cycle	36.0	—	34.0	19.8	18.0	17.5	—	14.0	10.2	67 VDC		
			200 A at 28 V, 100% duty cycle	23.5	—	22.8	13.5	12.0	12.7	—	10.2	6.9				
		Single-phase	5-200	200 A at 28 V, 50% duty cycle*	43.9	—	43.0	—	—	—	—	9.9	6.5			
			150 A at 26 V, 100% duty cycle*	35.0	—	32.9	—	—	—	—	—	7.6	4.8			

CST™ 280 Racks

See literature DC/18.82

Rugged enclosure provides simple means for protecting and transporting multiple welding power sources for construction, maintenance/repair and shipbuilding applications.



Light weight and small footprint for easy transportation. The low weight enables the use of elevators to move the rack.

The low weight enables the use of elevators to move the rack.

All controls including power switch are located on front of machine for easy access.

Top cover protects machines from falling debris.

Lift eyes simplify crane or overhead lifting device transport.

Lift truck fork pockets.

One main disconnect box with branched fusing for each machine.

Common output ground connection (for same polarity use only).

Optional rack running gear available for moving the rack.



See page 121

CST 280 8-pack rack shown.

Note: For additional rack systems see Dimension 650 ArcReach Rack on page 41 and XMT® Racks on page 45.

Heavy Industrial ● **CC DC 3**
Phase

Processes

- Stick (SMAW)
- TIG (GTAW)
- Air carbon arc cutting and gouging (CAC-A) (5/16 in. carbons with paralleled CST 280 units)

Most popular accessories



- 4-Pack Rack Running Gear 195114
- 8-Pack Rack Running Gear 195436

Visit MillerWelds.com or your distributor for other Miller® options and accessories.

Model	Stock Number	Rack Capacity	Input Power to Rack	Amps Input at Rated Output, 50/60 Hz 220 V 230 V 400 V 440 V 460 V 575 V	KVA	KW	Dimensions	Net Weight
4-Pack Rack	(907247) Tweco®	4 units	220-230/460-575 V, three-phase, 50/60 Hz. Note: CST 280 machines are factory-linked for 460-575 V.	137 134 79 72 70 57	58.4	40.8	H: 50.75 in. (1,289 mm) 4-pack W: 25.5 in. (648 mm)	355 lb. (161 kg)
8-Pack Rack	(907365) Tweco®	8 units	See above for information on CST 280.	274 268 158 145 140 114	116.8	81.6	8-pack W: 46 in. (1,168 mm) D: 26.5 in. (673 mm)	640 lb. (290 kg)
Empty Rack	(195051)	4 units	—	—	—	—	Same as 4-pack rack	166 lb. (75 kg)
	(300580)	8 units	—	—	—	—	Same as 8-pack rack	280 lb. (127 kg)



For more detailed information, visit

MillerWelds.com/tig

GTAW | **TIG**



Also see Multiprocess section for machines that can TIG weld.



Product Guide

Product	Page	Class	TIG	Pulsed TIG	Stick	CAC-A	MIG/Flux-cored	Max. Electrode Diameter					Material Thickness Range (TIG)	Welding Amperage Range	Pulse Capability	Net Weight	Generator Power Requirement
								E6010/11	E6013	E7018	E7024	CAC-A					
Maxstar® 161	52	●	●	●	●			5/32 in.	1/8 in.	1/8 in.	3/32 in.	—	.020-3/16 in.	5-160 A	0-150 pps (STH model)	13 lb. (5.9 kg)	5.3 kW
Maxstar® 210	54	●	●	●	●			3/16 in.	3/16 in.	5/32 in.	5/32 in.	—	.002-1/4 in.	1-210 A	0.1-250 pps (base model) 0.1-500 pps (DX model)	38 lb. (17.2 kg)	9 kW
Maxstar® 280	54	●	●	●	●			7/32 in.	3/16 in.	3/16 in.	3/16 in.	3/16 in.	.004-3/8 in.	1-280 A	0.1-250 pps (base model) 0.1-500 pps (DX model)	47 lb. (21.3 kg)	11 kW
Maxstar® 400	56	●	●	●	●			5/16 in.	5/16 in.	1/4 in.	1/4 in.	1/4 in.	.012-5/8 in.	3-400 A	0.1-5,000 pps	134 lb. (61 kg)	20 kW
Maxstar® 800	56	●	●	●	●			5/16 in.	5/16 in.	5/16 in.	5/16 in.	3/8 in.	.020-1 in.	5-800 A	0.1-5,000 pps	198 lb. (90 kg)	45 kW
Diversion™ 180	52	●	●					—	—	—	—	—	.030-3/16 in. (alum.) .025-3/16 in. (steel)	10-180 A	—	50 lb. (23 kg)	5.5 kW
Syncrowave® 210	53	●	●	●	●	●		5/32 in.	1/8 in.	1/8 in.	3/32 in.	—	.020-1/4 in. (aluminum/steel)	5-210 A	0.1-150 pps	133.5 lb. (61 kg)	6 kW
Dynasty® 210	54	●	●	●	●			3/16 in.	3/16 in.	5/32 in.	5/32 in.	—	.012-1/4 in. (alum.) .002-1/4 in. (steel)	2-210 A (AC) 1-210 A (DC)	0.1-250 pps (base, DC only) 0.1-500 pps (DX model)	47 lb. (21.3 kg)	9 kW
Dynasty® 280	54	●	●	●	●			7/32 in.	3/16 in.	3/16 in.	3/16 in.	3/16 in.	.012-3/8 in. (alum.) .004-3/8 in. (steel)	2-280 A (AC) 1-280 A (DC)	0.1-250 pps (base, DC only) 0.1-500 pps (DX model)	52 lb. (23.6 kg)	12.5 kW
Dynasty® 400	56	●	●	●	●			5/16 in.	5/16 in.	1/4 in.	1/4 in.	1/4 in.	.015-5/8 in. (alum.) .012-5/8 in. (steel)	3-400 A	0.1-500 pps (AC) 0.1-5,000 pps (DC)	134 lb. (61 kg)	20 kW
Dynasty® 800	56	●	●	●	●			5/16 in.	5/16 in.	5/16 in.	5/16 in.	3/8 in.	.020-1 in. (aluminum/steel)	5-800 A	0.1-500 pps (AC) 0.1-5,000 pps (DC)	198 lb. (90 kg)	50 kW
Syncrowave® 300	57	●	●	●	●			5/32 in.	5/32 in.	5/32 in.	5/32 in.	—	.015-3/8 in. (alum.) .012-1/2 in. (steel)	5-300 A	0.1-150 pps	101 lb. (45.8 kg)	9 kW

DC (Steel)

AC/DC (Aluminum/Steel)

Product Key

Class: ● Light industrial ● Industrial ● Heavy industrial Capability: ● All models ● Some models
New! products appear in blue type.

Diversion™ 180 AC/DC TIG

See literature AD/1.5

Professional-grade arc in a package designed specifically for personal users. Contains all of the features you need – simplicity combined with superior performance and value.



TIG Welding Capability

Max. 3/16 in. (4.8 mm)	Max. 3/16 in. (4.8 mm)
Steel	Aluminum
Min. 0.025 in. (0.6 mm)	Min. 0.030 in. (0.75 mm)



Multi-voltage plug (MVP™) allows for connection to 120- or 240-volt receptacles without tools. Choose the plug that fits the receptacle and connect it to the power cord.

Fan-On-Demand™ power source cooling system operates only when needed, reducing noise, energy use and the amount of contaminants pulled through the machine.

Auto-postflow adjusts the length of postflow time based on the amperage setting, shielding your tungsten and eliminating the need to set the postflow time.

Advanced squarewave AC provides a fast freezing weld puddle and deeper penetration.

Weldcraft™ A-150 torch with Diamond Grip™ provides more comfortable grip and reduces operator fatigue.

Easy-to-understand operator interface. Power up, select material type, set material thickness range and start welding!

Inverter-based AC/DC power source provides a more consistent welding arc while using less power.

HF arc starting for non-contact arc initiation that reduces tungsten and material contamination.

Portable. Easy to transport at 50 pounds.

*While idling.

Light industrial ● CC AC 1 DC Phase

Process - TIG (GTAW)

Comes with

- Power cord with MVP plugs for 120 V and 240 V
- 12.5 ft. (3.8 m) Weldcraft™ A-150 TIG torch
- 12 ft. (3.7 m) work cable with clamp
- RFCS-RJ45 remote foot control
- Flow gauge regulator with hose

Most popular accessories

- TIG Torch Accessory Kit AK2C (pg 66)
- Running Gear/Cylinder Rack 301239 (pg 114)
- Protective Cover 300579 (pg 120)
- RCCS-RJ45 Remote Fingertip Control 301146 (pg 120)
- RJ45 to 14-Pin Adapter Cord 300688
- Weldcraft™ Flexible Torch Body Kits (requires handle 105255R) A-125F (WP-9F) A-150F (WP-17F)

Visit MillerWelds.com or your distributor for other Miller® options and accessories.

AC/DC	Stock Number (907627)	Input Power	Welding Amp Range	Rated Output	Amps Input at Rated Output	KVA	KW	Max. Open-Circuit Voltage	Dimensions	Net Weight
		115 V	10-125	125 A at 15 V, 35% duty cycle	26.5 (.88*)	3.1 (.1*)	3.0 (.03*)	80 VDC	H: 17 in. (433 mm) W: 9.875 in. (251 mm) D: 23.875 in. (608 mm)	50 lb. (23 kg)
		230 V	10-180	150 A at 16 V, 20% duty cycle	16 (.44*)	3.7 (.1*)	3.6 (.03*)			
				180 A at 17.2 V, 10% duty cycle	20.5 (.44*)	4.7 (.1*)	4.6 (.03*)			

Maxstar® 161 STL and STH DC TIG and Stick

See literature DC/27.5

Maximum portability and performance provided in one compact TIG/stick package.



Maxstar 161 STH TIG/stick package with remote fingertip control shown – includes X-CASE.

TIG Welding Capability

Max. 3/16 in. (4.8 mm)
Steel
Min. 0.020 in. (0.5 mm)

Two models available. See page 48 in the Stick section for Maxstar 161 S. **STL:** DC TIG/stick with Lift-Arc™ starting without high frequency. **STH:** DC TIG/stick with high frequency and Lift-Arc™ starting, plus built-in pulsing from 0–150 pulses per second.

AUTO-LINE™ TECHNOLOGY Allows for any input voltage hookup (120–240 V) with no manual linking, providing convenience in any job setting.

Portable with adjustable handle/shoulder strap. Easy to transport at only 13 pounds.

Built-in gas solenoid eliminates need for a bulky torch with a gas valve.

Digital meter for more precise control.

Fan-On-Demand™ power source cooling system.

Superior stick arc performance even on the difficult-to-run electrodes like E6010.

Industrial ● CC DC 1 Phase

Processes

- TIG (GTAW) ■ Stick (SMAW)
- Pulsed TIG (GTAW-P) with STH model

Comes with

- 6.5 ft. (2 m) power cords for 120 V and 240 V
- 13 ft. (4 m) electrode cable with holder and 25 mm Dinse-style connector
- 10 ft. (3 m) work cable with clamp and 25 mm Dinse-style connector
- Air-cooled TIG torch connector
- Quick-reference guide

TIG/stick packages include above plus

- 12.5 ft. (3.8 m) Weldcraft™ A-150 TIG torch (WP1712RDI25)
- Protective X-CASE™ (301429)
- Flow gauge regulator with hose
- AK2C TIG torch accessory kit
- RCCS-6M remote fingertip control (packages 907710002 and 907711001 only)

Visit MillerWelds.com or your distributor for Miller® options and accessories.

*Sense voltage for stick and Lift-Arc™ TIG.

DC	Model/Stock Number	Model/Stock Number	Welding Process	Input Power	Welding Amp Range	Rated Output	Amps Input at Rated Output, 50/60 Hz	KVA at Duty Cycle	KW	Max. Open-Circuit Voltage	Dimensions	Net Weight
	Maxstar 161 STL (907710) Power source only (907710001) TIG/stick package (907710002) TIG/stick package with remote fingertip control	Maxstar 161 STH (907711) Power source only (907711001) TIG/stick package with remote fingertip control	TIG	120 V	5-130	130 A at 15.2 V, 30% duty cycle	22.6	2.73	2.70	48 VDC (12-16 VDC*)	H: 10.3 in. (262 mm) W: 5.6 in. (142 mm) D: 13.5 in. (343 mm)	13 lb. (5.9 kg)
				240 V	5-160	160 A at 16.4 V, 20% duty cycle	15.05	3.62	3.49			
			Stick	120 V	20-90	90 A at 23.6 V, 30% duty cycle	23.16	2.78	2.76			
				240 V	20-160	160 A at 26.4 V, 20% duty cycle	22.55	5.41	5.25			

Syncrowave® 210

AC/DC TIG, Stick and MIG (with Spool Gun)

See literature AD/4.6

Continuing the tradition of innovation through advanced inverter technology for light-industrial and personal users.



Syncrowave 210 Runner TIG/MIG Complete package shown.

 **WIRELESS REMOTE COMPATIBLE**
See page 121



Easy to use.
1) Turn power on.
2) Select the process.
3) Set amperage or voltage based on material thickness.
Then weld! It's easy as 1,2,3.

TIG Welding Capability

Max. 1/4 in. (6.4 mm)	
Steel	Aluminum
Min. 0.020 in. (0.5 mm)	

AUTO-LINE TECHNOLOGY Allows for any input voltage hookup (120-240 V) with no manual linking, providing convenience in any job setting. Ideal solution for dirty or unreliable power.



Multi-voltage plug (MVP™) allows for connection to 120- or 240-volt receptacles without tools. Choose the plug that fits the receptacle and connect it to the power cord.

Low power draw. Inverter-based power source provides full welding output from 240 volts while drawing less than 30 amps.

High-frequency (HF) arc starting for non-contact arc initiation, reducing tungsten and material contamination.

Pro-Set™ (TIG/stick) eliminates the guesswork when setting weld parameters. Use Pro-Set when you want the speed, convenience and confidence of preset controls.

AC frequency (TIG) controls the width of the arc cone and can improve directional control of the arc.

AC balance (TIG) control provides adjustable oxide removal which is essential for creating the highest quality aluminum welds.

Pulse (TIG). Pulsing can increase puddle agitation, arc stability and travel speeds while reducing heat input and distortion.

DIG (stick) control allows the arc characteristics to be changed for specific applications and electrodes. Lower the DIG setting for smooth running electrodes like E7018 and increase the DIG setting for stiffer, more penetrating electrodes like E6010.

Auto-Set™ (MIG) automatically sets your welder to the proper parameters. Simply set the wire size, material thickness, and shielding gas and you're ready to weld with the Spoolmate™ spool gun.

Light industrial 

- Processes**
- AC/DC TIG (GTAW) ▪ DC stick (SMAW)
 - Pulsed TIG (GTAW-P) ▪ MIG (GMAW)
 - Flux-cored (FCAW)

- Comes with**
- 10 ft. power cord with MVP plugs for 120 V and 240 V
 - 12.5 ft. (3.8 m) Weldcraft™ A-150 TIG torch (WP1712MFD150)
 - 12 ft. (3.7 m) work cable with clamp and Dinse-style connector
 - Electrode holder with Dinse-style connector
 - RFCS-14 HD heavy-duty remote foot control
 - Flow gauge regulator with hose
 - Factory-installed running gear with EZ-Change™ low cylinder rack
 - Quick-reference guide

- TIG/MIG Complete package includes above plus**
- Spoolmate™ 150 spool gun (301272)
 - 4-14 pin connector
 - Flow-thru Dinse-style connector

- Most popular accessories**
- 25 ft. (7.6 m) Weldcraft™ A-150 TIG Torch WP-17-25-R (pg 60)



- **TIG Torch Accessory Kit AK2C** (pg 66) Includes one short back cap, one of each size (#4, #5, #6) alumina nozzle, and one of each size (.040, 1/16, 3/32 in.) of the following: collet, collet body, and 7-inch 2% ceriated tungsten electrode
- **TIG Torch Accessory Kit AK-150MFC** (pg 66) Allows A-150 torch customization. Converts into 28 different torch styles while using existing cable. Includes collets, collet bodies, nozzles, torch heads, handle and more
- **Protective Cover 195142** (pg 120)
- **RCC-14 Remote Control 151086** (pg 120)
- **Wireless Remote Foot Control 300429** (pg 121)

Visit MillerWelds.com or your distributor for other Miller® options and accessories.

AC/DC	Stock Number (907596) Runner (951684) Runner TIG/MIG Complete (includes Spoolmate 150)	Input Power	Welding Process	Welding Amperage Range	Rated Output (R.M.S.)	Amps Input at Rated Output	Max. Open-Circuit Voltage	Dimensions	Net Weight
		115 V	DC TIG	5-125	95 A at 13.8 V, 60% duty cycle	17.4 (.58 while idling)	47 VDC	H: 31.5 in. (800 mm) W: 18.5 in. (470 mm) D: 43 in. (1092 mm)	Runner package: 133.5 lb. (61 kg) Runner TIG/MIG Complete package: 139.5 lb. (63 kg)
		AC TIG	5-125	90 A at 13.6 V, 60% duty cycle	12.4 (.58 while idling)				
		DC stick	20-90	70 A at 22.8 V, 60% duty cycle	20.5 (.58 while idling)				
		230 V	DC TIG	5-210	125 A at 15 V, 60% duty cycle	11.9 (.35 while idling)			
			AC TIG	5-210	114 A at 14.6 V, 60% duty cycle	8.62 (.35 while idling)			
			DC stick	20-150	90 A at 23.6 V, 60% duty cycle	11.9 (.35 while idling)			

Maxstar® and Dynasty® 210/280 Series

DC (Maxstar) and AC/DC (Dynasty) TIG and Stick

See literature DC/32.1 (Maxstar 210), DC/35.0 (Maxstar 280), AD/4.81 (Dynasty 210) and AD/4.9 (Dynasty 280)



See page 121

Maxstar and Dynasty 210 Series (Maxstar 210 shown).

Dynasty 280 DX

210 Series TIG Welding Capability

Max. 1/4 in. (6.4 mm)	Max. 1/4 in. (6.4 mm)
Steel	Aluminum (Dynasty only)
Min. 0.002 in. (0.05 mm)	Min. 0.012 in. (0.3 mm)

280 Series TIG Welding Capability

Max. 3/8 in. (9.5 mm)	Max. 3/8 in. (9.5 mm)
Steel	Aluminum (Dynasty only)
Min. 0.004 in. (0.1 mm)	Min. 0.012 in. (0.3 mm)

Base and DX models available. Base model provides essential TIG and stick functions. DX model adds extended ranges to sequencer, full trigger options, and full preflow and pulser functions.

Note: See page 40 in the Multiprocess section for the Maxstar 280 Multiprocess and Dynasty 280 DX Multiprocess, and see page 49 in the Stick section for the Maxstar 210 STR.

AUTO-LINE TECHNOLOGY Allows for any input voltage hookup (210 models: 120–480 V, 280 models: 208–575 V) with no manual linking, providing convenience in any job setting. Ideal solution for dirty or unreliable power.

Blue Lightning™ high-frequency (HF) arc starter for non-contact arc initiation. Provides more consistent arc starts and greater reliability compared to traditional HF arc starters.

Lift-Arc™ provides AC or DC arc initiation without the use of high frequency.

Hot Start™ adaptive control provides positive arc starts without sticking.

Auto-postflow adjusts the length of postflow time based on the amperage setting, shielding your tungsten and eliminating the need to set the postflow time.

Pro-Set™ eliminates the guesswork when setting weld parameters. Use Pro-Set when you want the speed, convenience and confidence of preset controls. Simply select the feature and adjust until Pro-Set appears on the display.

Sleep timer conserves electricity. This programmable feature will power down the machine if it sits idle for a specified time.

Update and expand. Front panel memory card data port provides the ability to easily update software and expand product features.

Optional cooler power supply (CPS) is an integrated 120-volt dedicated-use receptacle for the Coolmate™ 1.3. *Not available on Maxstar 210 Series.*

Cooler-On-Demand™ feature operates the auxiliary cooling system only when needed. Reduces noise, energy use, and airborne contaminants pulled through the cooler. *Only available on CPS models.*

*Refer to owner's manual for 208-volt output ratings and duty cycle.

**Sense voltage for low OCV stick and Lift-Arc™ TIG.

DC Maxstar	Model/ Stock Number	Welding Process	Input Power	Welding Amp Range	Rated Output at 60% Duty Cycle	Amps Input at Rated Load Output, 50/60 Hz								Max. Open- Circuit Voltage	Dimensions	Net Weight	
						120 V	208 V	230 V	240 V	400 V	460 V	480 V	575 V				KVA
Maxstar 210 (907683) Maxstar 210 DX (907684)	TIG	3-phase	1-210	210 A at 18.4 V	—	14	—	12	7	—	6	—	5.2	4.9	80 VDC (11 VDC**)	H: 13.6 in. (346 mm) W: 8.6 in. (219 mm) D: 19.5 in. (495 mm)	38 lb. (17.2 kg)
				1-phase	1-210	210 A at 18.4 V	—	24	—	20	12	—	10	—			
		1-phase (120 V)	1-150	125 A at 15 V	22	—	—	—	—	—	—	—	2.6	2.6			
	Stick	3-phase	5-210	160 A at 26.4 V	—	15	—	13	8	—	6	—	5.5	5.2			
				1-phase	5-210	160 A at 26.4 V	—	26	—	22	13	—	11	—			
		1-phase (120 V)	5-100	90 A at 23.6 V	23	—	—	—	—	—	—	—	2.8	2.8			
Maxstar 280 (907552) Maxstar 280 DX (907553) Maxstar 280 DX (907539) with CPS	TIG	3-phase	1-280	250 A at 20 V	—	21	19	—	11	9	—	7	7.6	7.3	60 VDC (11 VDC**)	H: 13.6 in. (346 mm) W: 8.6 in. (219 mm) D: 22.5 in. (569 mm)	47 lb. (21.3 kg) 50 lb. (22.7 kg) with CPS
				1-phase	1-280	250 A at 20 V	—	35	32	—	18	16	—	13			
	Stick	3-phase	5-280	250 A at 30 V	—	*	*	—	14	13	—	10	9.9	9.6			
				1-phase	5-280	180 A at 27.2 V	—	32	29	—	*	*	—	6.7			



Dynasty welders add AC TIG capabilities and the following AC features (limited on base model)

- Waveforms** for advanced squarewave, soft squarewave, sine wave and triangular wave.
- Balance** control provides adjustable oxide removal which is essential for creating the highest quality aluminum welds. DX models provide extended ranges.
- Frequency** controls the width of the arc cone and can improve directional control of the arc.



Dynasty 280 DX Complete package with wireless foot control and CPS shown.

Dynasty Water-Cooled Complete Packages

Additional packages are available — visit MillerWelds.com or your distributor.

Model	Packages with Foot Control and CPS	Packages with Wireless Foot Control and CPS
Dynasty 210	(951666)	(951667)
Dynasty 210 DX	(951668)	(951669)
Dynasty 280	(951466)	—
Dynasty 280 DX	(951468)	(951469)

*Refer to owner's manual for complete ratings.
 **Sense voltage for low OCV stick and Lift-Arc™ TIG.

Industrial 
CC ^{AC} **3** ^{DC} **1** ^{Phase} ^{Phase} Maxstar is DC only

- Processes**
- TIG (GTAW) ▪ Stick (SMAW)
 - Pulsed TIG (GTAW-P)
 - Air carbon arc (CAC-A) w/280 models

- Comes with**
- 8 ft. (2.4 m) power cord (no plug)
 - Two 50 mm Dinse-style connectors
 - Quick-reference guide (Dynasty only)

- Complete packages come with**
- 8 ft. (2.4 m) power cord (no plug)
 - Quick-reference guide
 - Small Runner™ cart
 - Coolmate™ 1.3
 - Coolant (four 1-gallon bottles)
 - Remote control (foot or wireless foot)
 - Weldcraft™ water-cooled torch kit
 Dynasty 210: W-250 (WP-20)
 Dynasty 280: W-280 (WP-280)

- Most popular accessories**
- 2-Wheel Trolley Cart 300971 (pg 115)
 - Small Runner™ Cart 301318 (pg 115)
 - Coolmate™ 1.3 300972 (pg 115)
 - Coolant 043810 (pg 115)

- Contractor Kits** (pg 120)
- 301309 A-150 w/RFCS-14 HD
 - 301311 A-150 w/RCCS-14
 - 301549 A-200 w/RFCS-14 HD
 - 301550 A-200 w/RCCS-14

- Weldcraft™ Water-Cooled Torch Kits** (pg 120)
- 300185 W-250 (WP-20)
 - 300990 W-280 (WP-280)
 - 301268 W-375
- Remote Controls** (pg 120-121)
- 043688 RCCS-14 fingertip control
 - 194744 RFCS-14 HD foot control
 - 300429 Wireless foot control

Visit MillerWelds.com or your distributor for other Miller® options and accessories.

Model/Stock Number	Welding Process	Input Power	Welding Amp Range	Rated Output at 60% Duty Cycle	Amps Input at Rated Load Output, 50/60 Hz								Max. Open-Circuit Voltage	Dimensions	Net Weight		
					120 V	208 V	230 V	240 V	400 V	460 V	480 V	575 V				KVA	KW
AC/DC Dynasty Dynasty 210 (907685) with CPS Dynasty 210 DX (907686) with CPS	TIG	3-phase	1-210	210 A at 18.4 V	—	14	—	12	7	—	6	—	5.2	4.9	80 VDC (11 VDC**)	H: 13.6 in. (346 mm) W: 8.6 in. (219 mm) D: 22.5 in. (569 mm)	47 lb. (21.3 kg) 50 lb. (22.7 kg) with CPS
			1-210	210 A at 18.4 V	—	24	—	20	12	—	10	—	4.9	4.9			
			1-150	125 A at 15 V	22	—	—	—	—	—	—	—	—	2.6			
	Stick	3-phase	5-210	160 A at 26.4 V	—	15	—	13	8	—	6	—	5.5	5.2			
			5-210	160 A at 26.4 V	—	26	—	22	13	—	11	—	5.3	5.3			
			5-100	90 A at 23.6 V	23	—	—	—	—	—	—	—	—	2.8			
Dynasty 280 (907550) with CPS Dynasty 280 DX (907551) with CPS	TIG	3-phase	2-280 (AC) 1-280 (DC)	250 A at 20 V	—	21	19	—	11	9	—	7	7.6	7.3	60 VDC (11 VDC**)	H: 13.6 in. (346 mm) W: 8.6 in. (219 mm) D: 22.5 in. (569 mm)	52 lb. (23.6 kg) 55 lb. (25 kg) with CPS
			2-280 (AC) 1-280 (DC)	250 A at 20 V	—	35	32	—	18	16	—	13	7.3	7.1			
	Stick	3-phase	5-280	250 A at 30 V	—	*	*	—	14	13	—	10	9.9	9.6			
			5-280	180 A at 27.2 V	—	32	29	—	*	*	—	*	6.7	6.5			
		1-phase	5-280	250 A at 30 V	—	*	*	—	14	13	—	10	9.9	9.6			
			5-280	180 A at 27.2 V	—	32	29	—	*	*	—	*	6.7	6.5			

Maxstar® and Dynasty® 400 and 800 DC (Maxstar) and AC/DC (Dynasty) TIG and Stick

See literature DC/24.5 (Maxstar) and AD/5.5 (Dynasty)



Dynasty 400

Dynasty 800



See page 121

TIG Welding Capability

800 Max. 1 in. (25.4 mm)	800 Max. 1 in. (25.4 mm)
400 Max. 5/8 in. (15.9 mm)	400 Max. 5/8 in. (15.9 mm)
Steel	Aluminum (Dynasty only)
400 Min. 0.012 in. (0.3 mm)	400 Min. 0.015 in. (0.4 mm)
800 Min. 0.020 in. (0.5 mm)	800 Min. 0.020 in. (0.5 mm)

Dynasty welders add AC TIG capabilities and the following AC features

Waveforms for advanced squarewave, soft squarewave, sine wave and triangular wave.

Balance control provides adjustable oxide removal which is essential for creating the highest quality aluminum welds.

Frequency controls the width of the arc cone and can improve directional control of the arc.

AC amplitude/amperage allows EP and EN amperages to be set independently to precisely control heat input to the work and electrode.

Dynasty 400 Complete package with wireless foot control shown.



AUTO-LINE TECHNOLOGY Allows for any input voltage hookup (208–575 V) with no manual linking, providing convenience in any job setting. Ideal solution for dirty or unreliable power.

Blue Lightning™ high-frequency (HF) arc starter for non-contact arc initiation. Provides more consistent arc starts and greater reliability compared to traditional HF arc starters.

Lift-Arc™ provides AC or DC arc initiation without the use of high frequency.

Hot Start™ adaptive control provides positive arc starts without sticking.

Auto-postflow adjusts the length of postflow time based on the amperage setting, shielding your tungsten and eliminating the need to set the postflow time.

Cooler power supply (CPS) is an integrated 120-volt dedicated-use receptacle for the Coolmate™ 3.5.

Program memory features nine independent program memories that maintain/save your parameters.

High-speed DC TIG pulse controls capable of 5,000 pulses per second.

*Sense voltage for low OCV stick and Lift-Arc™ TIG.

**See literature DC/24.5 and AD/5.5 for Complete package dimensions and weight.

Heavy Industrial
CC AC 3 1 DC Phase Phase Maxstar is DC only

Processes

- TIG (GTAW) ■ Stick (SMAW)
- Pulsed TIG (GTAW-P)
- Air carbon arc (CAC-A)

400 models come with

- 8 ft. (2.4 m) power cord (no plug)
- Two 50 mm Dinse-style connectors
- Quick-reference guide (Dynasty only)

800 models come with

- Thread-lock torch connector
- Two thread-lock weld cable connectors
- Quick-reference guide (Dynasty only)

Note: Power cord is NOT included with 800 models.

Complete packages include above plus

- Runner™ cart
- Coolmate™ 3.5
- Coolant (four 1-gallon bottles)
- Remote control (foot or wireless foot)
- Weldcraft™ water-cooled torch kit (400: W-375, 800: W-400)

Most popular accessories

- Runner™ Cart 300244 (pg 115)
- Coolmate™ 3.5 300245 (pg 115)
- Coolant 043810 (pg 115)



Weldcraft™ Water-Cooled Torch Kits

- (pg 120)
- 300185 W-250 (WP-20)
- 300990 W-280 (WP-280)
- 301268 W-375
- 300186 W-400 (WP-18SC)
- Remote Controls (pg 120–121)
- 043688 RCCS-14 fingertip control
- 194744 RFCS-14 HD foot control
- 300429 Wireless foot control

Visit MillerWelds.com or your distributor for other Miller® options and accessories.

	Model/Stock Number	Welding Process	Input Power	Welding Amp Range	Rated Output	Amps Input at Rated Load Output, 50/60 Hz						Max. Open-Circuit Voltage	Power Source Dimensions**	Power Source Net Weight**	
						208 V	230 V	400 V	460 V	575 V	KVA				KW
DC Maxstar	Maxstar 400 (907716) Power source only (951692) Complete w/foot (951693) Complete w/wireless foot	TIG/stick	3-phase	3-400	300 A at 32 V, 60% duty cycle	33	30	17	15	12	12.0	11.6	75 VDC (10–15 VDC*)	H: 24.75 in. (629 mm) W: 13.75 in. (349 mm) D: 22 in. (559 mm)	134 lb. (61 kg)
					250 A at 30 V, 60% duty cycle	48	43	24	20	16	10	9.2			
	Maxstar 800 (907718) Power source only	TIG/stick	3-phase	5-800	600 A at 44 V, 60% duty cycle	90	80	45	39	31	32	31	75 VDC (10–15 VDC*)	H: 34.5 in. (876 mm) W: 13.75 in. (349 mm) D: 22 in. (559 mm)	198 lb. (90 kg)
					500 A at 40 V, 60% duty cycle	126	112	61	53	41	26	24			
AC/DC Dynasty	Dynasty 400 (907717) Power source only (951694) Complete w/foot (951695) Complete w/wireless foot	TIG/stick	3-phase	3-400	300 A at 32 V, 60% duty cycle	36	33	19	16	13	13.1	12.5	75 VDC (10–15 VDC*)	H: 24.75 in. (629 mm) W: 13.75 in. (349 mm) D: 22 in. (559 mm)	134 lb. (61 kg)
					250 A at 29 V, 60% duty cycle	52	47	26	22	17	10.9	9.9			
	Dynasty 800 (907719) Power source only (951696) Complete w/foot (951697) Complete w/wireless foot	TIG/stick	3-phase	5-800	600 A at 44 V, 60% duty cycle	96	86	48	42	33	35	33	75 VDC (10–15 VDC*)	H: 34.5 in. (876 mm) W: 13.75 in. (349 mm) D: 22 in. (559 mm)	198 lb. (90 kg)
					500 A at 40 V, 60% duty cycle	136	122	66	56	44	28	26			

Syncrowave® 300 AC/DC TIG and Stick See literature AD/4.25



NEW!

TIG Welding Capability

Max. 1/2 in. (12.7 mm)		Max. 3/8 in. (9.5 mm)	
Steel		Aluminum	
Min. 0.012 in. (0.3 mm)		Min. 0.015 in. (0.4 mm)	



Industrial **CC** AC/DC **3** 1 Phase Phase

Processes

- TIG (GTAW) ▪ Stick (SMAW)
- DC pulsed TIG (GTAW-P)

Comes with

- 10 ft. (3 m) power cord (no plug)
- Two 50 mm Dinse-style connectors

Complete packages include above plus

- Running gear
- Coolmate™ 3 cooler
- Coolant (four 1-gallon bottles)
- Remote control (foot or wireless foot)
- Weldcraft™ W-280 water-cooled torch kit

Most popular accessories

- Coolant 043810 (pg 115)



- Weldcraft™ W-280 Water-Cooled Torch Kit 300990 (pg 120)
- Remote Controls (pg 120-121)
 - 043688 RCCS-14 fingertip control
 - 194744 RFCS-14 HD foot control
 - 300429 Wireless foot control

Visit MillerWelds.com or your distributor for other Miller® options and accessories.

Auto-Link® circuit automatically links the power source to primary voltage being applied (208/240/480 V, single- or three-phase).

AC balance control features adjustable cleaning action while increasing arc stability on various aluminum alloys, and helps eliminate tungsten spitting and arc rectification.

Blue Lightning™ high-frequency (HF) arc starter for non-contact arc initiation. Provides more consistent arc starts and greater reliability compared to traditional HF arc starters.

Lift-Arc™ provides AC or DC arc initiation without the use of high frequency.

Auto-postflow adjusts the length of postflow time based on the amperage setting, shielding your tungsten and eliminating the need to set the postflow time.

Pro-Set™ eliminates the guesswork when setting weld parameters. Use Pro-Set when you want the speed, convenience and confidence of preset controls.

Arc timer/cycle counter records actual welding time and number of arc starts. Great for estimating job costs.

Line voltage compensation keeps power source constant regardless of fluctuations in input power (±10 percent).

Coolmate™ 3 cooler (shown in Complete package). Three-gallon cooling system features a flow indicator to visually indicate system is working and an external filter to stop objects from entering the water-cooled torch cable.

*Sense voltage for low OCV stick and Lift-Arc™ TIG.
 **See literature AD/4.25 for Complete package dimensions and weight.

AC/DC	Model/Stock Number	Welding Process	Input Power	Welding Amp Range	Rated Output	Amps Input at Rated Output, 50/60 Hz					Max. Open-Circuit Voltage	Power Source Dimensions**	Power Source Net Weight**
						208 V	240 V	480 V	KVA	KW			
	Syncrowave 300 (907782) Power source only (951829) Complete w/foot (951830) Complete w/wireless foot	TIG (includes cooler power draw)	3-phase	5-300	210 A at 18.4 V, 60% duty cycle	16	14	7	5.9	5.5	60 VDC (13 VDC*)	H: 29.4 in. (746 mm) W: 15 in. (381 mm) D: 24.6 in. (625 mm)	101 lb. (45.8 kg)
			1-phase			27	24	12	5.7	5.5			
		Stick	3-phase	5-300	160 A at 26.4 V, 60% duty cycle	16	11	5	5.7	5.5			
			1-phase			27	23	11	5.7	5.5			

Weldcraft™ Series TIG Torches

Synonymous with versatility and performance, Weldcraft TIG torches can handle the most intricate to the most demanding TIG welding challenges. From the 125-amp hand-held MicroTIG® torch to the 500-amp machine-held water-cooled models, there's a Weldcraft torch for nearly every TIG application.

For more detailed information, visit MillerWelds.com/tigtorches



Setting the standard for performance

Super Cool™ technology provides additional surface area to increase cooling efficiency and capacity.

Comfort and control are increased with the lightweight, well-balanced body and handle designs, helping to reduce fatigue.

Robust performance through heavy copper construction that delivers maximum welding capacity for rugged fieldwork.

Simplify torch package installation with ColorSmart™ hose and cable sets that differentiate input water, water/power cable, and gas hoses.

Improve gas coverage and cooling capacity through the use of a gas lens.

Extreme reliability

Reduce downtime due to overheating through consistent water-cooled performance.

Extend parts life using the durable copper components, maximizing current capacity.

Reduce leakage of gas and water through secure mechanical fittings.

Works in cold weather with the Tri-Flex™ hose and cable assembly that remains flexible to ease handling and extends cable life.

TIG Torch Configurator

Our TIG Torch Configurator is a simple way to make sure you are using the right torch and consumables for your application.

Answer a few simple questions about your specific application and get a recommendation for the appropriate torch, tungsten, collet, collet body and more. Email or print the recommendation for reference when purchasing your next Weldcraft torch.

Visit now at MillerWelds.com/torchconfig

Miller Torch Product Selector

Choose Products

Torches Only

Consumables Only

Both Torches and Consumables

Next

Miller Torch Product Selector

Work Material

Mild Steel/Stainless Steel

Deoxidized Copper

Titanium

Magnesium

Aluminum

Previous Next

Miller Torch Product Selector Disclaimer

Part Number	Description	Quantity
WC332X7	2% Ceriated Tungsten (3/32" dia.)	1
54N63	Large Diameter GI Insulator	1
53N88XXX	#10 Large Dia. GI Alumina Nozzle XXL Long	1
10N24	Collet for 3/32" dia. Tungsten	1
45V64	Large Gas Lens for 3/32" dia. Tungsten	1
300M	Medium Back Cap	1

Reset Print Email

Weldcraft™ Air-Cooled Torches

Recommended for welding amperages under 250 amps. Air-cooled torches are great for portable applications as they do not require a water-circulator. For power sources without a built-in gas solenoid, the air-cooled two-piece torch is the solution of choice.

Weldcraft™ Water-Cooled Torches

Recommended for welding amperages above 200 amps. Offering a small torch design, water-cooled torches allow for precise control due to the efficient around-the-head cooling. This same cooling allows for extended torch life and higher amperage capacities.

Weldcraft™ Specialty Torches

Specialty torches are designed to fit best in unique applications. The **Modular Series** torches allow for a quick change to many different torch styles for any joint configuration. For those hard-to-reach areas the **W-125 MicroTIG®** torch provides access and superior maneuverability.

Weldcraft™ Automation Torches

Ideal for mechanized applications, the Weldcraft Automation Series offers air-cooled and water-cooled torches designed for high- and low-amperage mechanized applications.

Process

- TIG (GTAW)

Suggested power sources

- Multimatic™ 200/215 (pg 37) (A-150)
- Multimatic™ 220 AC/DC (pg 38) (A-150)
- Multimatic™ 255 (pg 39) (A-150)
- Maxstar® 280 Multiprocess (pg 40) (A-200, A-250, W-280)
- Dynasty® 280 DX Multiprocess (pg 40) (A-200, A-250, W-280)
- XMT Series (pg 42-45) (A-200, A-250)
- CST™ 280 (pg 50) (A-250)
- Maxstar® 161 STL/STH (pg 52) (A-150)
- Syncrowave® 210 (pg 53) (A-150)
- Maxstar®/ Dynasty® 210 (pg 54) (A-150, W-250)
- Maxstar®/ Dynasty® 280 (pg 54) (A-200, A-250, W-280)
- Maxstar®/ Dynasty® 400 (pg 56) (W-375)
- Maxstar®/ Dynasty® 800 (pg 56) (W-400)
- Syncrowave® 300 (pg 57) (W-280)

Weldcraft™ A-80 Series

See literature AY/21.0

Formerly known as WP-24 Series



Innovative air-cooled torches designed for intricate welding applications, especially in limited-access areas and on thin-gauge materials.

Featherweight torch body is well balanced to improve operator comfort and control.

Minimize discontinuities. Insulating gasket on torch body minimizes gas leakage and minimizes weld discontinuities.

Combined flexible neck and gas valve is ideal for optimal positioning and gas flow control (A-80 Flex Valve).

Applications

- Shipbuilding
- Motorsports
- Aerospace
- Restricted areas

Most popular consumables

- Collets
 - 53N16 .040 in. (1.0 mm)
 - 53N14 1/16 in. (1.6 mm)
 - 24C332 3/32 in. (2.4 mm)
- Collet Bodies
 - 53N18 .040 in. (1.0 mm)
 - 53N19 1/16 in. (1.6 mm)
 - 24CB332 3/32 in. (2.4 mm)
- Alumina Nozzles
 - A53N24 #4, 1/4 in.
 - A53N25 #5, 5/16 in.
 - A53N27 #6, 3/8 in.

Most popular accessories

- Collet Body Wrench 53N20
- Visit MillerWelds.com or your distributor for other Miller® options and accessories.

Model	Rubber		Type	Rated Output	Electrode Range
	12.5 ft. (3.8 m)	25 ft. (7.6 m)			
A-80 Flex	WP-24F-12-R	WP-24F-25-R	Air-cooled	DC: 80 A at 60% duty cycle AC: 50 A at 60% duty cycle	.020-3/32 in. (0.5-2.4 mm)
A-80 Flex Valve	WP-24FV-12-R	WP-24FV-25-R			

Weldcraft™ A-125 Series

See literature AY/22.0

Formerly known as WP-9 Series



Air-cooled torches designed for optimal control while welding thin-gauge materials, especially in hard-to-reach places.

Lightweight body reduces fatigue and downtime, while increasing operator comfort.

Pencil-style model without a back cap allows for superior access to confined areas (A-125 Pencil).

Combined flexible neck and gas valve for welding limited-access joints using power sources without gas solenoids (A-125 Flex Valve).

Applications

- Maintenance and repair
- Home/hobby ▪ Motorsports
- Metal art ▪ Fabrication

Most popular consumables

- Collets
 - 13N22 1/16 in. (1.6 mm)
 - 13N23 3/32 in. (2.4 mm)
 - 13N24 1/8 in. (3.2 mm)
- Collet Bodies
 - 13N27 1/16 in. (1.6 mm)
 - 13N28 3/32 in. (2.4 mm)
 - 13N29 1/8 in. (3.2 mm)
- Alumina Nozzles
 - 13N10 #6, 3/8 in.
 - 13N11 #7, 7/16 in.
 - 13N12 #8, 1/2 in.

Most popular accessories

- Accessory Kit AK1C (pg 66)

Visit MillerWelds.com or your distributor for other Miller® options and accessories.

Model	Rubber 12.5 ft. (3.8 m) 25 ft. (7.6 m)		2-Piece Rubber 12.5 ft. (3.8 m) 25 ft. (7.6 m)		Type	Rated Output	Electrode Range
	WP-9-12-R	WP-9-25-R	—	—			
A-125	WP-9-12-R	WP-9-25-R	—	—	Air-cooled	DC: 125 A at 60% duty cycle AC: 100 A at 60% duty cycle	.020-1/8 in. (0.5-3.2 mm)
A-125 Valve	WP-9V-12-R	WP-9V-25-R	—	WP-9V-25-2			
A-125 Flex	WP-9F-12-R	WP-9F-25-R	WP-9F-12-2	WP-9F-25-2			
A-125 Flex Valve	WP-9FV-12-R	WP-9FV-25-R	—	WP-9FV-25-2			
A-125 Pencil	WP-9P-12-R	WP-9P-25-R	—	—			

Weldcraft™ A-150 Series

See literature AY/23.0

Formerly known as WP-17 Series

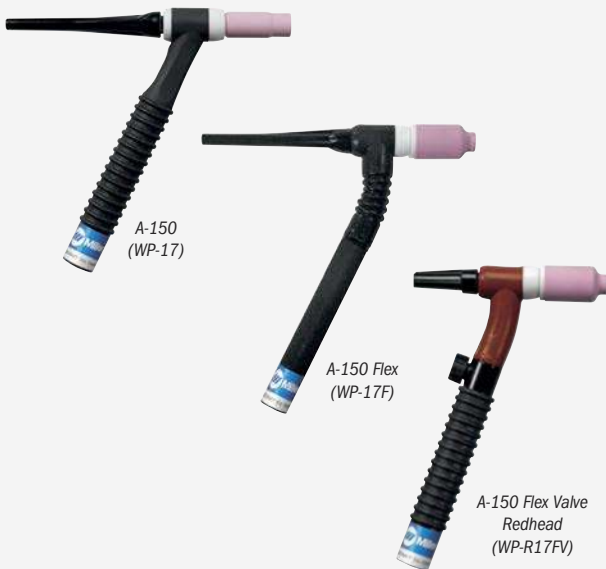

Versatile and innovative air-cooled torches designed for maximum comfort in a variety of applications.

Diamond Grip™ head design has ergonomic contact points for thumb and fingers. Provides a more comfortable grip and reduces operator fatigue (A-150 and A-150 Valve).

Improve control and comfort with a flexible neck that allows access into hard-to-reach areas (A-150 Flex).

Maximum versatility. Utilize the Redhead™ Series torches in a variety of welding applications without adding expenses.

Applications

- Fabrication ▪ Maintenance and repair
- Aerospace ▪ Food/beverage industry
- Metal art ▪ Petro/chemical
- Shipbuilding

Most popular consumables

- Collets
 - 10N23 1/16 in. (1.6 mm)
 - 10N24 3/32 in. (2.4 mm)
 - 10N25 1/8 in. (3.2 mm)
- Collet Bodies
 - 10N31 1/16 in. (1.6 mm)
 - 10N32 3/32 in. (2.4 mm)
 - 10N28 1/8 in. (3.2 mm)
- Alumina Nozzles
 - 10N48 #6, 3/8 in.
 - 10N47 #7, 7/16 in.
 - 10N46 #8, 1/2 in.

Most popular accessories

- Accessory Kit AK-150MFC (pg 66)
Converts A-150 into 28 different torch styles while using existing cable — includes collets, collet bodies, nozzles, torch heads, handle and more

Visit MillerWelds.com or your distributor for other Miller® options and accessories.

Model	Rubber 12.5 ft. (3.8 m) 25 ft. (7.6 m)		Mono-Flex™ 12.5 ft. (3.8 m) 25 ft. (7.6 m)		2-Piece Rubber 12.5 ft. (3.8 m) 25 ft. (7.6 m)		Type	Rated Output	Electrode Range
	WP-17-12-R	WP-17-25-R	WP-17-12-MF	WP-17-25-MF	WP-17-12-2	WP-17-25-2			
A-150	WP-17-12-R	WP-17-25-R	WP-17-12-MF	WP-17-25-MF	WP-17-12-2	WP-17-25-2	Air-cooled	DC: 150 A at 60% duty cycle AC: 115 A at 60% duty cycle	.020-1/8 in. (0.5-3.2 mm)
A-150 Valve	WP-17V-12-R	WP-17V-25-R	WP-17V-12-MF	WP-17V-25-MF	WP-17V-12-2	WP-17V-25-2			
A-150 Flex	WP-17F-12-R	WP-17F-25-R	—	—	—	WP-17F-25-2			
A-150 Flex Valve	WP-17FV-12-R	WP-17FV-25-R	—	—	WP-17FV-12-2	WP-17FV-25-2			
A-150 Flex Valve Redhead	WP-R17FV-12-R	WP-R17FV-25-R	—	—	—	—			

Weldcraft™ A-200 Series

See literature AY/24.0

Formerly known as WP-26 Series



Dependable, top-performing air-cooled torches designed for heavy-duty welding applications.

Eliminate the expense of a water-cooled system. The air-cooled capability of the A-200 Series pairs reliability with cost-effectiveness for all field applications.

Combined flexible neck and gas valve advances capabilities with greater comfort and control (A-200 Flex Valve).

Maximum versatility. Utilize the Redhead Series torches in a variety of welding applications without adding expenses.

Applications

- Fabrication
- Maintenance and repair
- Manufacturing
- Shipbuilding
- Vocational

Most popular consumables

- Collets
 - 10N23 1/16 in. (1.6 mm)
 - 10N24 3/32 in. (2.4 mm)
 - 10N25 1/8 in. (3.2 mm)
- Collet Bodies
 - 10N31 1/16 in. (1.6 mm)
 - 10N32 3/32 in. (2.4 mm)
 - 10N28 1/8 in. (3.2 mm)
- Alumina Nozzles
 - 10N47 #7, 7/16 in.
 - 10N46 #8, 1/2 in.
 - 10N45 #10, 5/8 in.

Most popular accessories



- **Gas Lens Kit AK3GL** (pg 66)
Includes one short back cap, one of each size (#6, #7, #8) alumina nozzle, and one of each size (1/16, 3/32, 1/8 inch) of the following: gas lens, collet, and 7-inch 2% ceriated tungsten electrode



- **Accessory Kit AK3C** (pg 66)
Includes one short back cap, one of each size (#5, #6, #8) alumina nozzle, and one of each size (1/16, 3/32, 1/8 inch) of the following: collet, collet body, and 7-inch 2% ceriated tungsten electrode
Visit MillerWelds.com or your distributor for other Miller® options and accessories.

Model	Rubber		2-Piece Rubber		Type	Rated Output	Electrode Range
	12.5 ft. (3.8 m)	25 ft. (7.6 m)	12.5 ft. (3.8 m)	25 ft. (7.6 m)			
A-200	WP-26-12-R	WP-26-25-R	WP-26-12-2	WP-26-25-2	Air-cooled	DC: 200 A at 60% duty cycle AC: 150 A at 60% duty cycle	.020-5/32 in. (0.5-4.0 mm)
A-200 Valve	WP-26V-12-R	WP-26V-25-R	WP-26V-12-2	WP-26V-25-2			
A-200 Flex	WP-26F-12-R	WP-26F-25-R	—	WP-26F-25-2			
A-200 Flex Valve	WP-26FV-12-R	WP-26FV-25-R	WP-26FV-12-2	WP-26FV-25-2			
A-200 Flex Redhead	WP-R26F-12-R	—	—	—			
A-200 Flex Valve Redhead	—	WP-R26FV-25-R	—	—			

Weldcraft™ A-250 Series

See literature AY/24.5



Dependable, top-performing air-cooled torches designed for heavy-duty welding applications.

Eliminate the expense of a water-cooled system. The air-cooled capability of the A-250 Series pairs reliability with cost-effectiveness for all field applications.

Robust performance. The heavy copper construction delivers optimal welding capacity for rugged fieldwork.

Effortless adjustments. Gas control valve ensures quick and easy adjustment of shielding gas flow (A-250 Valve).

Model	2-Piece Rubber, 25 ft. (7.6 m)	Type	Rated Output	Electrode Range
A-250	301525025	Air-cooled	DC: 250 A at 60% duty cycle AC: 188 A at 60% duty cycle	.020-5/32 in. (0.5-4.0 mm)
A-250 Valve	301526025			

Share Your Passion

Reviews & Ratings offer valuable insights to help guide your next purchase.

They're written and submitted by people who have purchased and used Miller equipment. If you'd like to share your experience and help your fellow welders select the right welding equipment consider writing a review. Simply visit the product page on the website for the product you want to write about and click on "Write a Review".

Visit now at MillerWelds.com

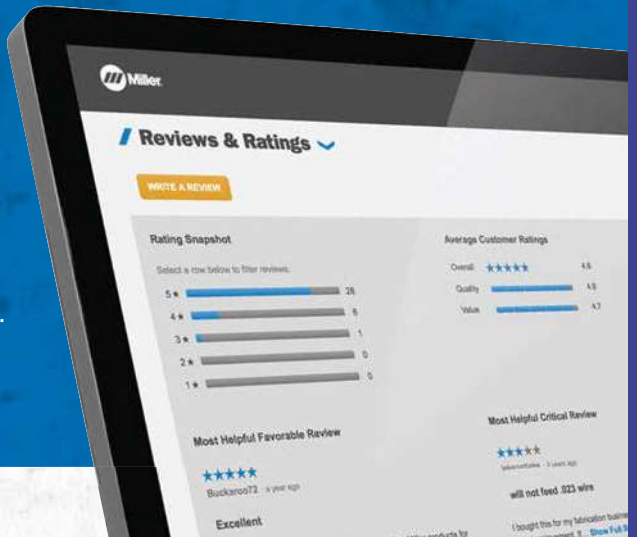

Weldcraft™ W-180

See literature AY/26.0

Formerly known as WP-24W



One of the smallest water-cooled TIG torches on the market and designed for welding in confined areas that require high amperage.

Use high amperage in confined areas for efficient welding.

Superior maneuverability in limited-access locations with the compact torch body.

Excellent weld capacity without increasing torch size, due to the efficient cooling system.

Applications

- Aerospace ▪ Manufacturing
- Food/beverage industry ▪ Shipbuilding
- Maintenance and repair
- Petro/chemical ▪ Precision fabrication

Most popular consumables

- Collets
 - 53N16 .040 in. (1.0 mm)
 - 53N14 1/16 in. (1.6 mm)
 - 24C332 3/32 in. (2.4 mm)
- Collet Bodies
 - 53N18 .040 in. (1.0 mm)
 - 53N19 1/16 in. (1.6 mm)
 - 24CB332 3/32 in. (2.4 mm)
- Alumina Nozzles
 - A53N24 #4, 1/4 in.
 - A53N25 #5, 5/16 in.
 - A53N27 #6, 3/8 in.

Model	Braided Rubber, 25 ft. (7.6 m)	Vinyl, 25 ft. (7.6 m)	Type	Rated Output	Electrode Range
W-180	WP-24W-25-R	WP-24W-25	Water-cooled	DC: 180 A at 100% duty cycle, AC: 115 A at 100% duty cycle	.020-3/32 in. (0.5-2.4 mm)

Weldcraft™ W-200 Pencil Flex

See literature AY/27.0

Formerly known as WP-25



Versatile water-cooled torch optimized for use in limited-access welding situations.

Pencil-style, flexible neck designed for both high-amperage applications and confined-area access.

Decreased downtime and longer trouble-free service due to overheating with the innovative cooling design.

Comfort and control are increased with the lightweight, well-balanced body design.

Applications

- Aerospace ▪ Aluminum fabrication
- Automotive ▪ Manufacturing
- Exotic material fabrication
- Precision metal fabrication
- Pressure vessel fabrication
- Shipbuilding ▪ Tool and die
- Tube and pipe ▪ Vocational

Most popular consumables

- Insulator (non-gas lens and gas lens) (required) 598882
- Collets (non-gas lens and gas lens)
 - 13N21 .040 in. (1.0 mm)
 - 13N22 1/16 in. (1.6 mm)
 - 13N23 3/32 in. (2.4 mm)
 - 13N24 1/8 in. (3.2 mm)
- Collet Bodies
 - 13N26 .040 in. (1.0 mm)
 - 13N27 1/16 in. (1.6 mm)
 - 13N28 3/32 in. (2.4 mm)
 - 13N29 1/8 in. (3.2 mm)
- Gas Lens
 - 45V42 .040 in. (1.0 mm)
 - 45V43 1/16 in. (1.6 mm)
 - 45V44 3/32 in. (2.4 mm)
 - 45V45 1/8 in. (3.2 mm)

Model	Braided Rubber		Vinyl		Type	Rated Output	Electrode Range
	12.5 ft. (3.8 m)	25 ft. (7.6 m)	12.5 ft. (3.8 m)	25 ft. (7.6 m)			
W-200 Pencil Flex	WP-25-12-R	WP-25-25-R	WP-25-12	WP-25-25	Water-cooled	DC: 200 A at 100% duty cycle AC: 140 A at 100% duty cycle	.020-1/8 in. (0.5-3.2 mm)

Weldcraft™ W-250 Series

See literature AY/29.0

Formerly known as WP-20 Series



W-250 (WP-20)

W-250 Valve (WP-20V)

Water-cooled torches that provide consistent performance and long-term trouble-free service with around-the-head water cooling.

Extend torch life and minimize downtime due to overheating with the efficient around-the-head cooling design.

Reduce leakage of gas and water through secure mechanical fittings and connections.

Easy hose replacement with the innovative mechanical fittings design (W-250 Valve).

- Alumina Nozzles
 - 13N08 #4, 1/4 in.
 - 13N09 #5, 5/16 in.
 - 13N10 #6, 3/8 in.
 - 13N11 #7, 7/16 in.
 - 13N12 #8, 1/2 in.
 - 13N13 #10, 5/8 in.
 - 53N58 #4, 1/4 in. (gas lens)
 - 53N59 #5, 5/16 in. (gas lens)
 - 53N60 #6, 3/8 in. (gas lens)
 - 53N61 #7, 7/16 in. (gas lens)
 - 53N61S #8, 1/2 in. (gas lens)

Most popular accessories



- Cable Covers
 - WC-3-10 10 ft. (3 m)
 - WC-3-22 22 ft. (6.7 m)

Visit MillerWelds.com or your distributor for other Miller® options and accessories.

Model	Braided Rubber		Vinyl		Type	Rated Output	Electrode Range
	12.5 ft. (3.8 m)	25 ft. (7.6 m)	12.5 ft. (3.8 m)	25 ft. (7.6 m)			
W-250	WP-20-12-R	WP-20-25-R	WP-20-12	WP-20-25	Water-cooled	DC: 250 A at 100% duty cycle AC: 180 A at 100% duty cycle	.020-1/8 in. (0.5-3.2 mm)
W-250 Valve	—	—	—	WP-20V-25			



Weldcraft™ W-280 Super Cool™

See literature AY/30.0

Formerly known as WP-280



Reliable water-cooled torch designed for demanding, high-amperage applications.

Super Cool technology provides additional surface area to increase cooling efficiency and capacity.

Reduce downtime due to overheating through consistent water-cooled performance.

Reduce leakage of gas and water through secure mechanical fittings and connections.

Model	Braided Rubber 12.5 ft. (3.8 m) 25 ft. (7.6 m)		Braided Rubber with 50 mm Dinse 25 ft. (7.6 m)	Type	Rated Output	Electrode Range
	301251012	301251025	301251001			
W-280 Super Cool	301251012	301251025	301251001	Water-cooled	DC: 280 A at 100% duty cycle AC: 195 A at 100% duty cycle	.020–1/8 in. (0.5–3.2 mm)

Weldcraft™ W-375 Super Cool™

See literature AY/32.5



Reliable water-cooled torch designed for demanding, high-amperage applications.

Super Cool technology provides additional surface area to increase cooling efficiency and capacity.

Reduce downtime due to overheating through consistent water-cooled performance.

Reduce leakage of gas and water through secure mechanical fittings and connections.

Model	Braided Rubber 12.5 ft. (3.8 m) 25 ft. (7.6 m)		Braided Rubber with 50 mm Dinse 25 ft. (7.6 m)	Type	Rated Output	Electrode Range
	301253012	301253025	301253001			
W-375 Super Cool	301253012	301253025	301253001	Water-cooled	DC: 375 A at 100% duty cycle AC: 265 A at 100% duty cycle	.020–1/8 in. (0.5–3.2 mm)

Weldcraft™ W-350 Series

See literature AY/32.0

Formerly known as WP-18 Series



Rugged water-cooled torches engineered for high-amperage and continuous hand-held welding in mechanized applications.

Reduce downtime and costs by minimizing overheating with the unique cooling design engineered for operator comfort.

Reduce discomfort and fatigue using the comfortable handle design.

Superior gas flow control offered through the built-in fingertip gas control (W-350 Valve).

Model	Rubber 12.5 ft. (3.8 m) 25 ft. (7.6 m)		Vinyl 12.5 ft. (3.8 m) 25 ft. (7.6 m)		Type	Rated Output	Electrode Range
	WP-18-12-R	WP-18-25-R	WP-18-12	WP-18-25			
W-350	WP-18-12-R	WP-18-25-R	WP-18-12	WP-18-25	Water-cooled	DC: 350 A at 100% duty cycle AC: 250 A at 100% duty cycle	.020–5/32 in. (0.5–4.0 mm)
W-350 Valve	–	WP-18V-25-R	–	WP-18V-25			

Applications

- Aerospace ▪ Aluminum fabrication
- Automotive ▪ Manufacturing
- Exotic material fabrication
- Precision metal fabrication
- Pressure vessel fabrication
- Shipbuilding ▪ Tool and die
- Tube and pipe ▪ Vocational

Most popular consumables

- Insulator (non-gas lens and gas lens) (required) 598882
- Collets (non-gas lens and gas lens)
 - 13N21 .040 in. (1.0 mm)
 - 13N22 1/16 in. (1.6 mm)
 - 13N23 3/32 in. (2.4 mm)
 - 13N24 1/8 in. (3.2 mm)
- Collet Bodies
 - 13N26 .040 in. (1.0 mm)
 - 13N27 1/16 in. (1.6 mm)
 - 13N28 3/32 in. (2.4 mm)
 - 13N29 1/8 in. (3.2 mm)
- Gas Lens
 - 45V42 .040 in. (1.0 mm)
 - 45V43 1/16 in. (1.6 mm)
 - 45V44 3/32 in. (2.4 mm)
 - 45V45 1/8 in. (3.2 mm)
- Alumina Nozzles
 - 13N08 #4, 1/4 in.
 - 13N09 #5, 5/16 in.
 - 13N10 #6, 3/8 in.
 - 13N11 #7, 7/16 in.
 - 13N12 #8, 1/2 in.
 - 13N13 #10, 5/8 in.
 - 53N58 #4, 1/4 in. (gas lens)
 - 53N59 #5, 5/16 in. (gas lens)
 - 53N60 #6, 3/8 in. (gas lens)
 - 53N61 #7, 7/16 in. (gas lens)
 - 53N61S #8, 1/2 in. (gas lens)
- Back Caps
 - 41V33 Short
 - 41V35 Medium
 - 41V24 Long

Most popular accessories

- Cable Covers
 - WC0183 11.75 ft. (3.6 m)
 - WC0182 24.25 ft. (7.4 m)
- Visit MillerWelds.com or your distributor for other Miller® options and accessories.

Applications

- Fabrication ▪ Manufacturing
- Maintenance and repair
- Shipbuilding ▪ Tube and pipe

Most popular consumables

- Collets
 - 10N24 3/32 in. (2.4 mm)
 - 10N25 1/8 in. (3.2 mm)
 - 54N20 5/32 in. (4.0 mm)
- Collet Bodies
 - 10N32 3/32 in. (2.4 mm)
 - 10N28 1/8 in. (3.2 mm)
 - 406488 5/32 in. (4.0 mm)
- Alumina Nozzles
 - 10N48 #6, 3/8 in.
 - 10N47 #7, 7/16 in.
 - 10N46 #8, 1/2 in.
 - 10N45 #10, 5/8 in.
 - 10N44 #12, 3/4 in.

Weldcraft™ W-400 Super Cool™

Formerly known as WP-18SC

See literature AY/33.0



Water-cooled torch designed to endure some of the most demanding applications while minimizing overheating.

Extend torch and consumable life with the full-flow water chamber that provides around-the-head cooling.

Improve gas coverage and cooling capacity with gas lens usage with heavy-duty stubby collet body.

Extend parts life using the durable copper components, maximizing current capacity.

Applications

- Heavy fabrication
- Tool and die
- Pipe and tube fabrication
- Pressure vessel fabrication

Most popular consumables

- Heavy-Duty Collets
 - 10N25HD 1/8 in. (3.2 mm)
 - 54N20HD 5/32 in. (4.0 mm)
 - 18C36 3/16 in. (4.8 mm)
- Heavy-Duty Nose Collet Body (all sizes) NCB-36
- Alumina Nozzles
 - 54N16 #6, 3/8 in.
 - 54N15 #7, 7/16 in.
 - 54N14 #8, 1/2 in.
- Back Caps
 - 57Y04 Short
 - 300M Medium

Model	Rubber, 25 ft. (7.6 m)	Vinyl, 25 ft. (7.6 m)	Type	Rated Output	Electrode Range
W-400 Super Cool	WP-18SC-25-R	WP-18SC-25	Water-cooled	DC: 400 A at 100% duty cycle, AC: 280 A at 100% duty cycle	.020-3/16 in. (0.5-4.8 mm)

Weldcraft™ Modular Series

See literature AY/36.0



Air-cooled and water-cooled torches engineered to weld multiple joint configurations for various applications and angles.

Built-in, efficient cooling system reduces overheating to extend parts and consumable life.

Modular design minimizes costs and downtime for torch changeover and parts inventory.

Easy configurable head options provide greater flexibility and joint access, minimizing downtime for torch changeover.

Gas valve provides greater shielding gas flow control (A-150 Modular Valve).

Applications

- Maintenance and repair
- Aerospace
- Metal art
- Food/beverage industry
- Petro/chemical
- Shipbuilding
- Manufacturing
- Vocational
- Precision fabrication
- Tube and pipe

Most popular accessories



- **Accessory Kit** (pg 66)
 - AK-150MFC For A-150 torch
 - AK-225MFC For W-225 torch

Model	Rubber 12.5 ft. (3.8 m)	25 ft. (7.6 m)	Type	Rated Output (Torch head dependent)	Electrode Range (Torch head dependent)
A-150 Modular	WP-150-12-R	WP-150-25-R	Air-cooled	DC: 150 A at 60% duty cycle AC: 105 A at 60% duty cycle	.020-1/8 in. (0.5-3.2 mm)
A-150 Modular Valve	WP-150V-12-R	WP-150V-25-R			

Model	Braided Rubber 12.5 ft. (3.8 m)	25 ft. (7.6 m)	Vinyl 25 ft. (7.6 m)	Type	Rated Output (Torch head dependent)	Electrode Range (Torch head dependent)
W-225 Modular	WP-225-12-R	WP-225-25-R	WP-225-25	Water-cooled	DC: 225 A at 100% duty cycle AC: 160 A at 100% duty cycle	.020-5/32 in. (0.5-4.0 mm)

Weldcraft™ W-125 Long Micro

Formerly known as WP-125L

See literature AY/25.0



Water-cooled MicroTig® torch designed for limited-access joints.

Small 5-inch torch body designed for limited-access joints.

Low-profile nozzle fits into holes as small as 5/8-inch diameter.

45-degree, 90-degree, and 180-degree options improve access in tight areas.

Lower maintenance costs incurred with the replaceable silicone rubber insulator and head components.

Applications

- Aerospace
- Food/beverage industry
- HVAC
- Automotive
- Petro/chemical
- Precision fabrication

Most popular consumables

- 90° Chucks
 - 125C40-90 .040 in. (1.0 mm)
 - 125C116-90 1/16 in. (1.6 mm)
 - 125C332-90 3/32 in. (2.4 mm)
- 90° Glass Nozzle (all sizes) 125N90 (other nozzles are available)



Model	Braided Rubber 12.5 ft. (3.8 m)	25 ft. (7.6 m)	Vinyl 25 ft. (7.6 m)	Type	Rated Output	Electrode Range
W-125 Long Micro	WP-125L-12-R	WP-125L-25-R	WP-125L-25	Water-cooled	DC: 125 A at 100% duty cycle AC: 80 A at 100% duty cycle	.040-3/32 in. (1.0-2.4 mm)



Weldcraft™ Automation Series

See literature AY/37.0



A-150
Automation
(WP-23A)



W-250
Automation
(WP-22A)



W-500A
Automation
(WP-27A)



W-500B
Automation
(WP-27B)

Air-cooled and water-cooled torches designed for high- and low-amperage mechanized applications.

Minimize downtime associated with tungsten changeover by using the front or back tungsten loading areas.

Built-in gas lens improves gas coverage to minimize shielding gas turbulence and improve weld quality (W-500A Automation and W-500B Automation).

Handle the most demanding high-amperage applications (W-500 Automation).

Applications

- Aerospace
- Food/beverage industry
- Pressure vessel fabrication
- Petro/chemical

Most popular accessories

▪ Cable Covers

- WC-3-10 10 ft. (3 m)
- WC-3-22 22 ft. (6.7 m)
- WC-4-10 10 ft. (3 m)
- WC-4-22 22 ft. (6.7 m)



- **Air-Cooled Torch 1-Piece Power Cable Connector** (pg 121)
195378 50 mm Dinse-style



195377 225028

- **Water-Cooled Torch 1-Piece Power Cable Connectors** (pg 121)
195377 50 mm Dinse-style
225028 50 mm thread-lock

Visit MillerWelds.com or your distributor for other Miller® options and accessories.

Model	Rubber, 12.5 ft. (3.8 m)		2-Piece Rubber, 12.5 ft. (3.8 m)			Type	Rated Output	Electrode Range
A-150 Automation	WP-23A-12-R		WP-23A-12-2			Air-cooled	DC: 150 A at 60% duty cycle AC: 120 A at 60% duty cycle	.040-3/32 in. (1.0-2.4 mm)
Model	Rubber 3 ft. (0.9 m) 12.5 ft. (3.8 m)		Vinyl 3 ft. (0.9 m) 12.5 ft. (3.8 m) 25 ft. (7.6 m)			Type	Rated Output	Electrode Range
W-250 Automation	—	—	WP-22A-3	WP-22A-12	WP-22A-25	Water-cooled	DC: 250 A at 100% duty cycle AC: 180 A at 100% duty cycle	.040-1/8 in. (1.0-3.2 mm)
W-500A Automation	WP-27A-3	WP-27A-12	—	—	—	Water-cooled	DC: 500 A at 100% duty cycle AC: 350 A at 100% duty cycle	.040-1/4 in. (1.0-6.4 mm)
W-500B Automation	WP-27B-3	WP-27B-12	—	—	—	Water-cooled	DC: 500 A at 100% duty cycle AC: 350 A at 100% duty cycle	.040-1/4 in. (1.0-6.4 mm)

Weldcraft™ Tungsten

Tungsten for the most demanding TIG welding applications!

Available in four types and industry-standard diameters, our line of Weldcraft tungsten electrodes has undergone rigorous testing to ensure the highest quality and durability. Color-coded packages include ten 7-inch (175 mm) tungsten electrodes.

Type	Stock Number	Diameter in. (mm)	Type	Stock Number	Diameter in. (mm)
2% Ceriated (EWCe-2)			Pure (EWP)		
Performs well in DC welding and arc starting at low-current settings. Offers excellent performance in AC processes.	WC040X7	0.040 (1.0)	Forms a clean, balled end when heated. Provides good arc stability for AC welding with a balanced or unbalanced squarewave or sine wave.	—	0.040 (1.0)
	WC116X7	1/16 (1.6)		WP116X7	1/16 (1.6)
	WC332X7	3/32 (2.4)		WP332X7	3/32 (2.4)
	WC018X7	1/8 (3.2)		WP018X7	1/8 (3.2)
WC532X7	5/32 (4.0)	—	5/32 (4.0)		
2% Lanthanated (EWLa-2)			Rare Earth (EWG)		
Provides excellent arc starting, arc stability and re-ignition, and less tip erosion in AC or DC welding. Can substitute for 2% Thoriated.	WL2040X7	0.040 (1.0)	Combines the best of all alloying elements, and provides excellent arc stability in AC or DC welding.	—	0.040 (1.0)
	WL2116X7	1/16 (1.6)		WG116X7	1/16 (1.6)
	WL2332X7	3/32 (2.4)		WG332X7	3/32 (2.4)
	WL2018X7	1/8 (3.2)		WG018X7	1/8 (3.2)
	WL2532X7	5/32 (4.0)		—	5/32 (4.0)



Note: Refer to manufacturer SDS sheets for proper preparation and safety. Use proper ventilation/capture during preparation. Refer to manufacturer warning regarding ventilation.

Weldcraft™ TIG Torch Accessories

GL Kits (Gas Lens Kits)

Gas lenses improve the gas coverage of the tungsten during the TIG welding process. They can save you time and money by increasing your weld quality while using less gas. GL kits provide three different-sized gas lenses and consumables in each kit to work with a variety of different applications.



size (1/16, 3/32, 1/8 inch) of the following: gas lens, collet, and 7-inch 2% ceriated tungsten electrode.



size (#6, #7, #8) alumina nozzle, and one of each size (1/16, 3/32, 1/8 inch) of the following: gas lens, collet, and 7-inch 2% ceriated tungsten electrode.

AK Kits (Accessory Kits)

AK kits provide a set of different consumables for Weldcraft torches to tackle a variety of different applications. Kits include nozzles, collets, collet bodies, tungsten and back caps.



nozzle, and one of each size (.040, 1/16 inch) of the following: collet, collet body, and 7-inch 2% ceriated tungsten electrode.



nozzle, and one of each size (.040, 1/16, 3/32 inch) of the following: collet, collet body, and 7-inch 2% ceriated tungsten electrode.



each size (#5, #6, #8) alumina nozzle, and one of each size (1/16, 3/32, 1/8 inch) of the following: collet, collet body, and 7-inch 2% ceriated tungsten electrode.

AK3GL
For A-150, A-200 and A-250. Includes one short back cap, one of each size (#6, #7, #8) alumina nozzle, and one of each

AK4GL
For W-200, W-225, W-250, W-280 Super Cool and W-375 Super Cool. Includes one short back cap, one of each

AK1C
For A-125 Series. Includes one long back cap, one of each size (#4, #5, #6) alumina

AK2C
For A-150 Series. Includes one short back cap, one of each size (#4, #5, #6) alumina

AK3C
For A-200 Series, A-250 Series and W-350 Series. Includes one short back cap, one of



one of each size (#5, #6, #7) alumina nozzle, and one of each size (1/16, 3/32, 1/8 inch) of the following: collet, collet body, and 7-inch 2% ceriated tungsten electrode.



collet, one of each size (.020-1/8 inch, 1/8-3/16 inch) collet body, and one of each size (3/32, 1/8, 5/32 inch) 7-inch 2% ceriated tungsten electrode.



nozzle, and one of each size (.040, 1/16 inch) of the following: 180-degree chuck, 45-degree chuck, 90-degree chuck, and 7-inch 2% ceriated tungsten electrode.



application. Kit converts into 28 different torch styles while using the A-125 and A-150 existing cable. Features collets, collet bodies, nozzles, torch heads, handle and more.



Also includes the following ten collets: (1) .040, (3) 1/16, (3) 3/32, (2) 1/8, (1) 5/32; and eight collet bodies: (1) .040, (2) 1/16, (2) 3/32, (2) 1/8, (1) 5/32.

AK4C
For W-250 Series, W-280 Super Cool and W-375 Super Cool. Includes one long back cap,

AK18C
For W-400 Super Cool. Includes one short back cap, one of each size (#6, #7, #8) alumina nozzle, one of each size (3/32, 1/8 HD, 5/32 HD)

AK125C
For W-125 Long Micro. Includes one of each size (180°, 45°, 90°, 90° short) glass

AK150MFC
For A-125 Series, A-150 Series and A-150 Modular Series. Allows welding operators to customize their standard A-125 (WP-9) or A-150 (WP-17) TIG torch for their specific

AK225MFC
For W-225 Modular. Includes five additional torch heads, collets, collet bodies, nozzles, handle and more.

MAK-2S
For W-350 Series. Includes one short and one long back cap, four back cap o-rings, two cup gaskets, one gas lens insulator, and one of each size (.040, 1/16, 3/32, 1/8 inch) gas lens.

Quick Connects



QRG
Allows for quick connection and removal of torch shielding gas hoses.



QRW
Allows for quick connection and removal of torch coolant hoses.

Cable Covers



WC-3-10 10 ft. (3 m)
WC-3-22 22 ft. (6.7 m)
WC-3-48 48 ft. (14.6 m)
Cable covers protect the welding cables from the day-to-day wear and tear of common welding environments. Available in 10-foot, 22-foot, and 48-foot lengths, these covers can help prevent the frequent replacement of expensive welding cables.

Remote Controls

See pages 120-121 in Accessories section for stock numbers and more information.



East/west rotary-motion fingertip current/contactor controls.



North/south rotary-motion fingertip current/contactor controls.



Foot pedal current/contactor controls.



Miniature hand current/contactor controls.



Momentary- and maintained-contact rocker switch for contactor control.



Momentary-contact switch for contactor controls.



Remote on/off control.



For more detailed information, visit

MillerWelds.com/insight

Welding Intelligence™



Transform data into actionable information that drives continuous improvement.

Insight Centerpoint version 10 available.

See page 69 for more information.

Insight

WELDING INTELLIGENCE™

Core / Centerpoint / ArcAgent



Improve weld quality



Manage costs



Increase productivity

Complete coverage for any application.



Manufacturing



Automation



Submerged arc

Choose the Right Welding Intelligence System

		Insight Core™	Insight Centerpoint™	Insight ArcAgent™
For Use With	Factory-Installed	<ul style="list-style-type: none"> Continuum™/Auto-Continuum™ (standard) 	<ul style="list-style-type: none"> Continuum™/Auto-Continuum™ (optional) 	<ul style="list-style-type: none"> ANY welding power source (old or new) ANY brand ANY welding process
	Field-Installed/Activated	<ul style="list-style-type: none"> 14-pin compliant power source (see MillerWelds.com/insight) 	<ul style="list-style-type: none"> Continuum™/Auto-Continuum™ 	
Requirements		<ul style="list-style-type: none"> Internet connection (wired/wireless) 	<ul style="list-style-type: none"> PC and Ethernet connection 	<ul style="list-style-type: none"> See Insight Core/Centerpoint requirements
What Capability Do You Need?		<ul style="list-style-type: none"> Productivity monitoring Weld parameter verification Simplicity/basic monitoring Goal setting Analytic tools 	<ul style="list-style-type: none"> Prevent/detect missed welds Minimize overwelding/underwelding Electronic work instructions Measure overall equipment effectiveness (OEE) 	<ul style="list-style-type: none"> Universal solution for use with Insight Core or Insight Centerpoint
Data Storage		<ul style="list-style-type: none"> Cloud based 	<ul style="list-style-type: none"> Local server or PC 	<ul style="list-style-type: none"> See Insight Core/Centerpoint requirements

Insight Core™

Simple, cloud-based welding information management solution that reports operator productivity and deposition, as well as weld parameter verification.

Helps you answer

- Who is your most productive operator?
- What is your most productive welder, station, cell?
- Are your quality risks increasing or decreasing?
- What are your true welding costs?

Software features

Productivity dashboard. Instant visibility of arc-on time and wire deposition — by location, work cell, power source or operator.

Quality dashboard. Real-time analysis and reporting of all welds, revealing when quality fails to meet established thresholds for amps, volts and WFS. Includes weld trace.

Reports. In-depth information is available in reports that can be easily modified and displayed in a wide variety of customizable formats.

Analytics tools. Business analytic tools allowing for weld data analysis based on individual/cell performance as well as overall financial terms.

Notifications. Email/text notifications based on your desired frequency and subject.

Multiple languages available. English, German, Spanish, French, Italian, Dutch, Portuguese and Chinese.



How it works



No mandatory subscription fees



Uses standard web browsers; no software or applications to install or maintain



Onboard memory for those times when internet connections go down



Innovative USB setup support for quick installation, easy data transfer and fast firmware updates

Universal brand capability

With an ArcAgent™ module, you can have the power of Insight Core on any machine from any manufacturer, giving you complete coverage of your facility.

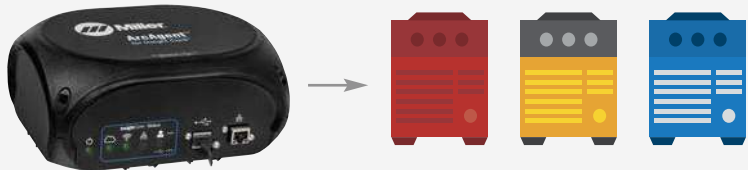

¹ Additional stock numbers are available — visit MillerWelds.com/insight.

² SubArc Digital Series requires Insight Core to SubArc Digital Series Adapter Kit (301295).

³ TIG applications require TIG Filter (301359) to monitor voltage.

Type	Continuum Power Sources ¹	Miller 14-Pin Compliant Power Sources	Universal Adaptability (works with ALL brands/models of power sources)
Factory-Installed Insight Core	Continuum 350 (907636) Continuum 500 (907640) Auto-Continuum 350 (907656) Auto-Continuum 500 (907657)	—	—
Field-Installed Insight Core	—	Requires Insight Core 14-pin module (301072) ² See MillerWelds.com/insight for a list of 14-pin compatible power sources	Requires ArcAgent for Insight Core (951773) with Stud output (951772) with Dinse output ³

Insight Centerpoint™

Advanced, real-time operator feedback solution to prevent missed welds, enforce proper weld sequences and ensure consistent weld quality.

Version 10

- Designed for ease of use
- Faster start up time
- Drastically shortened learning curve

Software features

Part Tracking™ provides real time operator feedback to ensure accurate weld sequence, prevent missed welds and ensure proper weld parameters.

WorkFlow™ enables you to present electronic work instructions for pre-weld, intra-weld, and post-weld activities (using video, pdf, and more) to ensure consistent standardized production for every operator.

Job tracking. A browser-based user interface eliminates the need for a PC in the workstation, allowing an operator to easily record everything that goes into creating a part.



Benefits for everyone in your operation



Improve weld quality

- Create a full record of every weld on every part
- Present welders with step-by-step instructions
- Have confidence that parts are properly welded



Manage costs

- Save time inspecting welds
- Identify the impact of non-welding activities
- Keep your welders welding



Increase productivity

- Identify the true cost of a welded component
- Collect data to drive decisions
- Stop losing money due to missing or poor welds

How it works

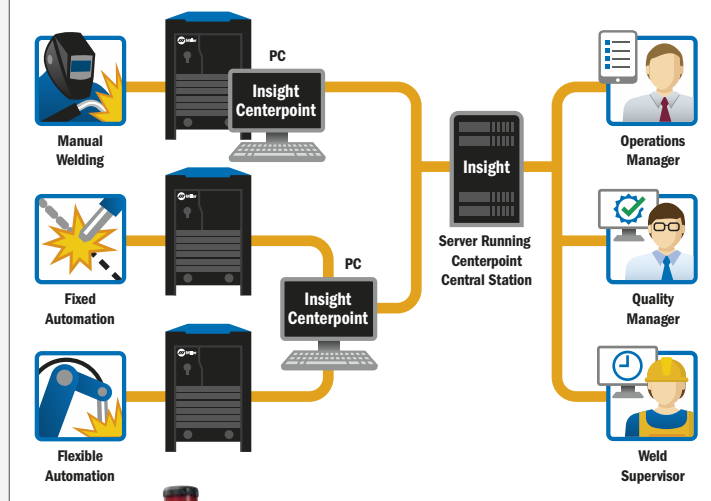

For more information:

Call **1-844-463-4328** or email insight@MillerWelds.com

Universal brand capability

With an ArcAgent™ module, you can have the power of Insight Centerpoint on any machine from any manufacturer, giving you a complete picture of your facility.

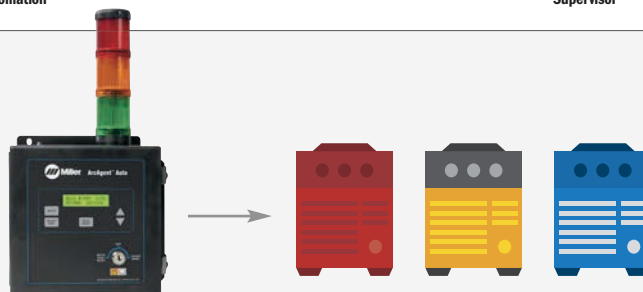

¹ Additional stock numbers are available – visit MillerWelds.com/insight.

Type	Continuum Power Sources ¹	Universal Adaptability (works with ALL brands/models of power sources)	Insight Centerpoint Software	Accessories
Optional Factory-Installed Insight Centerpoint	Continuum 350 (907636) Continuum 500 (907640) Auto-Continuum 350 (907656) Auto-Continuum 500 (907657)	–	(951809)	Insight LTD Gun (Q4015JS3EML) For Continuum Insight LTD Remote (301383) M12/RJ45 Ethernet Cables (300734) 9.8 ft. (3 m) (300736) 32.8 ft. (10 m)
Field-Installed Insight Centerpoint	–	Requires ArcAgent Manual or Auto (301343) Manual with front panel Part Tracking controls (301345) Manual with Insight torch capability (301346) Auto	(301485)	Field Application Support (195480) Miller field support (contact distributor for details)



Engine-Driven

For more detailed information, visit



MillerWelds.com/enginedriven



Product Guide

	Page	Class	Stick	MIG	Flux-cored*	AC TIG	DC TIG	PAC**	CAC-A	Portability	Weldable Metals	Continuous Generator Pwr. (watts)	Welding Amperage Range	Engine Brand	Special Features	Typical Applications
Gasoline	Fusion 160	71	●	●				●		Optional lift eye or running gear	Steel	6,200	30-160 DC	Kohler	Portable, PowerShift technology, inverter stick	Maintenance, construction, repair, service trucks
	Blue Star® 185	71	●	●				●	●			6,200	60-195 DC	Kohler	Compact	
	Bobcat™ 200 Air Pak™	73	●	●	●		●	●		Lift eye, optional running gear or trailer	Steel, stainless aluminum	6,500	30-210 DC	Kohler	Air compressor, battery charge/crank assist, Auto-Speed™ inverter CC/CV	Service trucks, repair, maintenance, farm/ranch
	Bobcat™ 225	74	●	●	●	●	●	●			Steel, stainless, aluminum	9,500	60-160 AC 40-225 DC	Kohler	Cost-effective AC/DC stick	Maintenance, farm/ranch, construction
	Bobcat™ 3 Phase	74	●	●	●	●	●	●				10,000	40-225 AC 40-210 DC	Kohler	Backup power for pivot irrigation	Farm/ranch
	Trailblazer® 302 Air Pak™	78	●	●	●	●	●	●		3/16"			11,000	10-225 AC 10-350 DC	Kohler	AC/DC, CC/CV, air compressor, battery charge/crank assist
Gas or LP	Bobcat™ 250	74	●	●	●	●	●		3/16"	Lift eye, optional running gear or trailer	Steel, stainless, aluminum	9,500	40-250 DC	Kohler	Most popular engine drive, AC/DC; optional EFI	Fab, maintenance, farm/ranch, construction
	Trailblazer® 325	76	●	●	●	●	●		3/16"		Steel, stainless	10,500 (Gas) 10,000 (LP)	10-325 DC (Gas) 10-305 DC (LP)	Kohler	ArcReach® (most models), Auto-Speed™; optional EFI, Excel™ power, battery charge/crank assist	Fab, maintenance, structural, repair, pipe
Diesel	Bobcat™ 200 Air Pak™ Diesel	73	●	●	●		●	●		Lift eye, optional running gear or trailer	Steel, stainless, aluminum	6,500	30-210 DC	Kubota	Air compressor, battery charge/crank assist, Auto-Speed™ inverter CC/CV	Service trucks, repair, maintenance, farm/ranch
	Bobcat™ 250 Diesel	74	●	●	●	●	●		3/16"		Steel, stainless, aluminum	9,500	40-250 DC	Kubota	Contractor's choice, AC/DC stick, strong FCAW	Fab, maintenance, farm/ranch, construction
	Trailblazer® 325 Diesel	76	●	●	●	●	●		3/16"		Steel, stainless	10,500	10-325 DC	Kubota	ArcReach®, Auto-Speed™; optional Excel™ power	Fab, maintenance, structural, repair, pipe
	Big Blue® 400 Pro	78	●	●	●	●	●		3/16"	Lift eye, optional trailer	Steel, stainless	10,000	20-400 DC	CAT, Kubota, Mitsubishi	Quiet, compact, fuel efficient; optional ArcReach®	Construction, repair
	Big Blue® 400 PipePro®	79	●	●	●	●	●		1/4"			10,000	20-400 DC	CAT, Mitsubishi	ArcReach®, Line-X® top cover, lift-off service door; optional stainless steel	Cross country pipeline
	Big Blue® 450 Duo CST™	79	●	●		●	●		3/16"			10,000	5-450 DC	Mitsubishi	Dual operator in a compact package	Construction, fabrication, pipe
	Big Blue® 500 Pro	80	●	●	●	●	●		5/16"	Lift eye, generally mounted on optional trailer	Steel, stainless	20,000	20-500 DC	Kubota	Quiet, fuel efficient; optional ArcReach®	Construction, repair
	Big Blue® 600 Series	80	●	●	●	●	●		3/8"			20,000	20-600 DC	Kubota (Pro), Deutz (Air Pak)	Quiet, powerful, fuel efficient; optional ArcReach® – Air Pak™ model has ArcReach® standard and adds air compressor	Construction, repair, maintenance, mining, rail
Big Blue® 800 Series	81	●	●	●	●	●		1/2"			20,000	20-800 DC	Deutz	ArcReach®, heavy duty, dual operator – Air Pak™ model adds air compressor	Construction, repair, maintenance, mining, rail	

Product Key

Class: ● Light industrial ● Industrial ● Heavy industrial Capability: ● Designed for this process ● Capable of this process
 New! or Improved! products appear in blue type. *If using self-shielded wire, use CV weld output. **With appropriate Spectrum plasma cutter.

Fusion 160

See literature ED/2.8

Delivers a smooth, stable arc from either engine power or 120/240-volt utility power, providing a unique combination of versatility and productivity in a lightweight package.



POWER SHIFT

Work anywhere convenience.

PowerShift technology provides weld capabilities using either the Fusion 160 gasoline engine or 120/240-volt utility power. You'll have the confidence of knowing

that you can weld virtually anywhere – outdoors and indoors – with just one machine. The multi-voltage plug (MVP™) makes it easy to connect the welder to either 120- or 240-volt power.

Easier to transport. At only 242 pounds, the Fusion 160 is up to 45 pounds less than similar machines, so moving it is easier and faster. Less time is spent waiting, and more work can get done.

Less rework. Inverter technology delivers a smooth, stable stick arc that's forgiving of variations in arc length and travel speed, so it's easier to produce clean welds that meet specifications – and avoid the time and expense of rework.

Light industrial ● **CC DC** 1 Phase

Process

- Stick (SMAW)

Gasoline engine

Kohler CH440: 13.4 hp at 3,600 rpm
One-cylinder, four-cycle, OHV, air-cooled

Note: Engine is warranted separately by engine manufacturer.

Most popular accessories

- Lifting Eye 195353 (pg 116)
- Running Gear 301246 (pg 116)
- Twist Lock Adapter Cord 301489 (pg 116)
- Protective Cover 301245 (pg 116)

Visit MillerWelds.com or your distributor for other Miller® options and accessories.

Gasoline	Stock Number	Input Power	Welding Mode	Welding Process	Amperage Range	Rated Output at 104°F (40°C)	Amps Input at Rated Output, 50/60 Hz, 1-Phase	Single-Phase Generator Power at 104°F (40°C)	Dimensions	Net Weight
	907773 Kohler with electric start	Engine power	CC/DC	DC stick	30-160	160 A at 26.4 V, 20% duty cycle 110 A at 24.4 V, 100% duty cycle	–	Peak: 6,500 watts Continuous: 6,200 watts	H: 24.75 in. (629 mm) W: 20.125 in. (510 mm) D: 31.25 in. (794 mm)	242 lb. (110 kg)
		PowerShift 120 V			30-100	90 A at 23.6 V, 40% duty cycle	22.7	–		
		PowerShift 240 V			30-160	160 A at 26.4 V, 20% duty cycle 110 A at 24.4 V, 100% duty cycle	25.0	–		

Blue Star® 185

See literature ED/2.5

Reliable outdoor portable power! Great for farm, ranch, maintenance, construction and hobbyist.



Compact and portable, its small footprint uses little truck space. Optional running gear also makes the Blue Star one-man portable.

All engine controls are on front panel.

Stick and TIG capable.

Accu-Rated™ peak generator power is usable for maximum generator loads such as plasma cutting, Millermatic® MIG welders and motor starting.

Includes electric start, 120-volt GFCI and 240-volt receptacles, 6.25-gallon fuel capacity, auto-idle and engine hour meter.

Light industrial ● **CC DC**

Processes

- Stick (SMAW) ▪ TIG (GTAW)

Gasoline engine

Kohler CH440: 13.4 hp at 3,600 rpm
One-cylinder, four-cycle, OHV, air-cooled

Note: Engine is warranted separately by engine manufacturer.

Most popular accessories

- Lifting Eye 195353 (pg 116)
- Running Gear 301246 (pg 116)
- Protective Cover 301245 (pg 116)

Visit MillerWelds.com or your distributor for other Miller® options and accessories.

Gasoline	Stock Number	Welding Mode	Welding Process	Amperage Range	Rated Output at 104°F (40°C)	Single-Phase Generator Power at 104°F (40°C)	Dimensions	Net Weight
	907664 Kohler	CC/DC	DC stick/TIG	60-195	185 A at 25 V, 20% duty cycle 150 A at 25 V, 100% duty cycle	Peak: 6,500 watts Continuous: 6,200 watts	H: 24.75 in. (629 mm) W: 20.625 in. (524 mm) D: 31.25 in. (794 mm)	296 lb. (134 kg)

Bobcat™/Trailblazer® Gas Model Comparison – Which is Right for You?

*Based on typical usage – 150 amps welding 40% of the time; 20 amps generator power 30% of the time; and idling without load 30% of the time.

Bobcat: The most popular welder/generator

- Dependable power and weld output
- Cost-effective multiprocess welder/generator
- Easy to maintain
- Quietest in its class



Trailblazer: The best performer in the industry

- Unbeatable arc performance
- Independent welder and generator power system
- Exclusive technologies – Auto-Speed™ and Excel™ power
- Most fuel efficient and quietest in its class



Sound Levels (at 23 feet)	Bobcat 225 (page 74)	Bobcat 250 (page 74)	Trailblazer 325 (page 76)
At Maximum Load / At 150 Amps	73.5 dB / 72 dB	72.5 dB / 72 dB	74 dB/65 dB
Sound Quality	Good	Very good	Excellent
Fuel System			
Typical Runtime per 12-Gallon Tank*	13 hours	13/ 15.5 hours with EFI	Up to 21 hours with options
Efficiency	Good	Good/ Very good with EFI	Excellent
Type	Gasoline	Gasoline or LP	Gasoline or LP
Delivery	Carburetor	Carburetor or EFI available	Carburetor or EFI available
Generator			
Peak Watts	11,000 watts	11,000/ 12,000 watts with EFI	12,000 watts
Clean Power Quality	Very good/ Excellent	Very good/ Excellent	Excellent
Power While Welding	Fair/ Good – With voltage control set near maximum	Good – Easier to fine-tune with arc voltage control near maximum	Independent weld and generator power with no interaction between tools and welding arc
Excel™ Power Generator (120 V, 60 Hz at all engine speeds)	–	–	Excel power available
Weld Performance			
Stick	Good/ Very good	Very good	Excellent
MIG – Wire (solid/ FCAW), Steel	Fair (.035 in.)	Good (.035–1/16 in.)	Excellent (.023–1/16 in.)
MIG – Wire, Aluminum w/ Spool Gun	Fair/ Good (add WC-115A with contactor)	Very good (add WC-115A with contactor)	Excellent (add WC-24)
DC TIG (steel)	Good	Very good	Excellent
AC Weld	60–160 amps	40–250 amps	Add Dynasty® (page 54)
Carbon Arc Gouging	–	Good Carbons: Rated 3/16 in.	Very good Carbons: Rated 3/16 in., Capable 1/4 in.
Key Features			
Digital Meters	–	–	With Sunvision™
Maintenance Displays	Hours/ Oil change	Hours/ Oil change/ Fuel	Hours/ Oil change/ Fuel/ rpm
Battery Charge/ Crank Assist	–	–	12 and 24 volt available
14-pin Receptacle	–	–	With Auto Remote Sense™
ArcReach	–	–	ArcReach technology standard (on most models)

Bobcat™/Trailblazer®/Big Blue® Air Pak™ Comparison – Which is Right for You?

Cost-effective welder/generator/air compressor/battery charger



Bobcat 200 Air Pak (page 73)

AC/DC multiprocess welder/generator/air compressor/battery charger



Trailblazer 302 Air Pak (page 78)

Quiet and powerful multiprocess welder/generator/air compressor



Big Blue 600 Air Pak (page 80)

Heavy-duty, dual-operator welder/generator/air compressor



Big Blue 800 Duo Air Pak (page 81)

	Bobcat 200 Air Pak (page 73)	Trailblazer 302 Air Pak (page 78)	Big Blue 600 Air Pak (page 80)	Big Blue 800 Duo Air Pak (page 81)
Compressed Air	30 cfm, 175 psi	31 cfm, 160 psi	60 cfm, 100 psi	60 cfm, 100 psi
Battery Charge/Crank Assist	12 and 24 volt	12 and 24 volt	–	–
Generator Power	Single-phase	Peak: 8,000 watts Continuous: 6,500 watts	Peak: 15,000 watts Continuous: 12,000 watts	Peak: 15,000 watts Continuous: 12,000 watts
	Three-phase	–	Peak: 27,000 watts Continuous: 20,000 watts	Peak: 27,000 watts Continuous: 20,000 watts
Weld Output Range	30–210 amps (CV/DC, CC/DC)	10–300 amps (CV/DC, CC/DC, CC/AC)	20–600 amps (CV/DC, CC/DC)	Single weld mode: 40–800 amps Dual weld mode: 20–400 amps (CV/DC, CC/DC)
Fuel Type	Gas/Diesel	Gas	Diesel	Diesel
Size	29.78 x 20 x 44.61 in. (gas) 29.75 x 20 x 47.25 in. (diesel)	28 x 20 x 59.625 in.	46 x 28.5 x 69.5 in.	46 x 28.5 x 69.5 in.
Weight	514 lb. (gas), 618 lb. (diesel)	771 lb.	2,040 lb.	2,095 lb.
ArcReach	–	–	ArcReach technology standard	ArcReach technology standard

Bobcat™ 200 Air Pak™ See literature ED/4.36

Quiet, fuel-efficient all-in-one that maintains power capabilities in a compact, lightweight footprint and is backed by industry-leading reliability and performance.



IMPROVED!
Bobcat 200 Air Pak (gas)
now with Auto-Speed technology
and multiprocess weld capabilities.

NEW!
Bobcat 200 Air Pak Diesel

Maximize available payload. Reduce weight by up to 600 pounds and increase available payload by up to 24 cubic feet by reducing the equipment on the truck.

Reduce fuel consumption. Minimize fuel costs by reducing truck engine idle time by as much as 75 percent, or if you have a separate engine-driven compressor by only operating one engine.

Minimize operating costs. Potentially save more than \$50,000 over ten years from increased fuel efficiency, decreased maintenance costs and increased asset life.

Advanced Auto-Speed™ technology automatically adjusts engine speed to match weld and battery charge demands – reducing fuel consumption, maintenance costs and noise for more efficient jobsites.

Industrial rotary-screw air compressor. Easily outperforms and outlasts reciprocating compressors. Many air tools can be powered by the compressor including most 3/4-inch impact wrenches. Immediately supplies 30 cfm at 175 psi, 100 percent duty cycle, continuous air output.

210-amp welder. Maximize downtime and delays by making metal repairs in the field to stay on schedule.

6,500-watt generator power to support jobsite tools, lights, and high-demand applications like plasma cutters and TIG welders.

Battery charge/crank assist. Provides up to 100 amps at idle to quickly charge 12- and 24-volt batteries. Jobsite equipment with weak batteries can get up to 300 amps of crank assist.

Light industrial 

Process

- Stick (SMAW) • MIG (GMAW)¹
- Flux-cored (FCAW)¹ • DC TIG (GTAW)²

¹With voltage-sensing feeder.

²Two-piece TIG torch recommended.

Engines

EFI gas: Kohler ECH730

23.5 hp at 3,600 rpm
Twin-cylinder, four-cycle, overhead valve, industrial, air-cooled

EPA Tier 4 Final Diesel: Kubota D722

19 hp at 3,600 rpm
Three-cylinder, industrial, liquid-cooled

Note: Engines are warranted separately by engine manufacturer.

Most popular accessories

- ArcReach® SuitCase® Feeders (pg 18)
- Spoolmate™ 200 300497 (pg 27)
- Spoolmatic® 30A 130831 (pg 28)
- Spectrum® 375 X-TREME™ (pg 90)
- Multi-Terrain Running Gear 301460 (pg 116)
- Full KVA Adapter Cord 300517 (pg 116)
- Protective Cover (pg 116)
 - 301475 Gas without running gear
 - 301476 Gas with running gear
 - 301531 Diesel without running gear
 - 301532 Diesel with running gear
- HWY-Mid Frame Trailer 301438 (pg 117)
- 25 ft. Battery Charge/Jump Cables with Plug 300422
- Air Compressor Oil Heater 301448
- Air Dryer Kit 301488
- Spool Gun Extension Hose and Cable Kit 132228

Visit MillerWelds.com or your distributor for other Miller® options and accessories.

	Model/Stock Number	Welding Mode	Welding Process	Amp/Volt Ranges	Rated Weld Output at 104°F (40°C)	Single-Phase Generator Power at 104°F (40°C)	Dimensions	Net Weight
Gasoline	Bobcat 200 Air Pak (907771) Kohler	CC/DC	DC stick/TIG	30-210 A	120 A at 25 V, 100% duty cycle 140 A at 26 V, 60% duty cycle 210 A at 28 V, 20% duty cycle	Peak: 8,000 watts Continuous: 6,500 watts	H: 24.25 in. (616 mm) H: 29.78 in. (756 mm) to top of exhaust W: 20 in. (508 mm) D: 44.61 in. (1,133 mm)	514 lb. (233 kg)
		CV/DC	MIG/FCAW	15-26 V	120 A at 20 V, 100% duty cycle 140 A at 21 V, 60% duty cycle 210 A at 25 V, 20% duty cycle			
Diesel	Bobcat 200 Air Pak Diesel (907760) Kubota	CC/DC	DC stick/TIG	30-210 A	120 A at 25 V, 100% duty cycle 140 A at 26 V, 60% duty cycle 210 A at 28 V, 20% duty cycle	Peak: 8,000 watts Continuous: 6,500 watts	H: 28.875 in. (734 mm) H: 29.75 in. (756 mm) to top of exhaust W: 20 in. (508 mm) D: 47.25 in. (1,200 mm)	618 lb. (280 kg)
		CV/DC	MIG/FCAW	15-26 V	120 A at 20 V, 100% duty cycle 140 A at 21 V, 60% duty cycle 210 A at 25 V, 20% duty cycle			
Rotocomp Air Compressor		Features			Free Air Delivery	Working Pressure	Duty Cycle	Oil Capacity
		Rotary screw with electric clutch for on/off, oil change intervals 500 hours			30 cfm (0.85 m ³ /min.) at 3,600 rpm	80-175 psig	100%	2 qt. (1.89 L)

Bobcat™ Series Gas, LP and Diesel



Bobcat 225

Bobcat 250 EFI

The legendary Bobcat welder/generator is reliable, powerful and durable. One of the smallest and lightest in its class.

Versatile AC and DC welding

Provides AC and DC welding output for greater versatility and quality welds on all types of metals. DC is smooth and easy to run while AC stick is used when arc blow occurs.

Stronger generator power

11,000 watts (12,000 on Bobcat 250 with EFI) of truly usable generator power that is Accu-Rated™, not inflated – tested to deliver uninterrupted peak output for a minimum of 30 seconds for big loads, so you can get more jobs done.

Advanced generator technology virtually eliminates power spikes and other electrical imperfections so welds are cleaner and jobsite tools can run without interruption, maximizing quality, productivity and profit.

Easier maintenance

Easy-to-read front panel maintenance displays show engine hours and hours left before an oil change is due. This intuitive design makes maintenance fast and easy.

- Oil checks from the top by the front panel
- Toolless panels that allow for quick access
- Single-side fuel fill and oil drain/filter

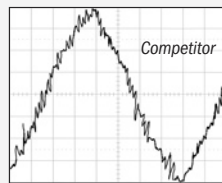
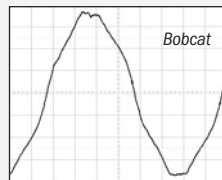

Waveform Comparison

Quieter and better sound

Up to 33 percent sound reduction.

Significant improvements in sound level and quality offer better jobsite communication, which provides a more efficient working environment for you and your crew. Bobcat welder/generators have rotated the engine toward the front to create more efficient airflow, resulting in significantly quieter operation. Now you can start your job earlier in the day and end it later, as well as work around hospitals, businesses, and residential areas.



More portable, uses less truck space

Smaller and lighter. Up to 17 percent less cubic space and weighing up to 100 pounds less than other welder/generators in their class – means moving Bobcat welder/generators is faster and easier, for maximum productivity. Bobcat welder/generators take up less space on trucks and trailers – leaving more room on your truck for other equipment and tools. Plus, they're easier to move safely around jobsites – even with weld cables and running gear attached.

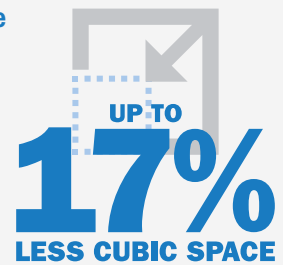

Bobcat™ 225 (Gas) See literature ED/4.4

Cost-effective, multiprocess welder/generator primarily used for stick welding. Great for farm, ranch, maintenance/repair and as a stand-alone generator.

Features three DC stick/TIG controls, one AC stick/TIG control and one wire range for output control. Stick ranges designed for 3/32, 1/8 and 5/32 inch. Very easy to set.



Bobcat™ 3 Phase (Gas) See literature ED/4.33

Designed for farm and ranch owners in need of single- and three-phase power to run 480-volt three-phase pivot irrigation systems or to provide backup power for home, farm and/or ranch.

Bobcat™ 250 (Gas, LP or Diesel) See literature ED/4.4 (Gas/LP) and ED/4.34 (Diesel)

MOST POPULAR! Multiprocess engine-driven welder/generator capable of carbon arc gouging features a larger stabilizer for less spatter and smoother arc. Ideal welder/generator for maintenance/repair, construction, farm/ranch or as a stand-alone generator.

Convenient front panel fuel gauge.

More precise amperage settings with wider range for optimal stick/flux-cored welding.

Features four AC/DC stick/TIG controls and two wire ranges for output control. Stick ranges designed for 3/32, 1/8, 5/32 and 3/16 inch. Very easy to set.



Add optional electronic fuel injection (EFI) – improved fuel efficiency for maximum productivity and profitability

Adding EFI to your Bobcat 250 welder/generator provides multiple benefits. With EFI you'll get faster, more reliable starts in any weather – no choke adjustments needed. EFI-equipped Bobcat 250 machines are also up to 42 percent more fuel efficient than standard carbureted models, improving profitability. Plus, refueling less frequently means you'll spend more of your time welding, improving productivity.

**Electric fuel pump recommended for operation at altitudes above 5,000 feet.*

Industrial 

Processes

- AC/DC stick (SMAW)
- MIG (GMAW)¹ = Flux-cored (FCAW)¹
- AC²/DC TIG (GTAW)
- Air carbon arc cutting and gouging (CAC-A)³ (rated 3/16 in. carbons)

¹With voltage-sensing feeder.

²With Dynasty® 210 Series.

³Bobcat 250 models only.

Engines

Gas: Kohler CH730

23.5 hp at 3,600 rpm

EFI gas: Kohler ECH730

23 hp at 3,600 rpm

LP: Kohler CH730

Liquid withdrawal LP system

21.5 hp at 3,600 rpm

V-twin-cylinder, four-cycle, overhead valve, industrial, air-cooled

EPA Tier 4 Final Diesel: Kubota D722

19 hp at 3,600 rpm

Three-cylinder, industrial, liquid-cooled

Note: Engines are warranted separately by engine manufacturer.

Most popular accessories

- ArcReach® SuitCase® Feeders (pg 18)
- Dynasty® 210 Series (pg 54)
- Spectrum® 625 X-TREME™ (pg 90)
- Multi-Terrain Running Gear (pg 116)
- Off-Road Running Gear (pg 116)
- Protective Cage with Cable Holders (pg 116)
- Hose and LP Tank Mounting Assembly (pg 116)
- Remote Oil Drain/Filter Kit (pg 116)
- All-Purpose Running Gear (pg 116)
- Full KVA Adapter Cord 300517 (pg 116)
- Protective Cover (pg 116)
- HWY-Mid Frame Trailer 301438 (pg 117)
- GFCI Panel Mount 120 VAC Duplex Kit 300975
- Electric Fuel Pump Kit 300976 (for gas models only)
Recommended for operation at altitudes above 5,000 feet
- Spark Arrestor Kit 300924 (for gas models only)

Visit MillerWelds.com or your distributor for other Miller® options and accessories.

	Model	Stock Number	Welding Mode	Welding Process	Amp/Volt Ranges	Rated Output at 104°F (40°C)	Generator Power at 104°F (40°C)	Dimensions	Net Weight
Gasoline	Bobcat 225	(907498001) Kohler (907498) Kohler with GFCI	CC/AC	Stick/TIG	60-160 A	150 A at 25 V, 100% duty cycle	Single-phase Peak: 11,000 watts Continuous: 9,500 watts	H: 28 in. (711 mm) H: 32.75 in. (832 mm) to top of exhaust W: 20 in. (508 mm) D: 40.5 in. (1,029 mm)	485 lb. (220 kg)
			CC/DC	Stick/TIG	40-225 A	225 A at 25 V, 100% duty cycle			
			CV/DC	MIG/FCAW	19-28 V	200 A at 20 V, 100% duty cycle			
Gasoline	Bobcat 3 Phase	(907505) Kohler with GFCI	CC/AC	Stick/TIG	40-225 A	200 A at 25 V, 100% duty cycle	Single-phase/three-phase Peak: 11,000 watts Continuous: 9,500 watts/10,000 watts		495 lb. (225 kg)
			CC/DC	Stick/TIG	40-210 A	210 A at 25 V, 100% duty cycle			
			CV/DC	MIG/FCAW	19-28 V	200 A at 20 V, 100% duty cycle			
Gas or LP	Bobcat 250	(907500001) Kohler (907500) Kohler with GFCI (907500002) Kohler with electric fuel pump* (907502) EFI Kohler (907504) LP Kohler with GFCI <i>Order hose and LP tank mounting assembly (300917) separately</i>	CC/AC	Stick/TIG	40-250 A	250 A at 25 V, 60% duty cycle 225 A at 25 V, 100% duty cycle	Single-phase Peak: 11,000 watts Continuous: 9,500 watts EFI model Peak: 12,000 watts Continuous: 10,500 watts	H: 28 in. (711 mm) H: 32.75 in. (832 mm) to top of exhaust W: 20 in. (508 mm) D: 40.5 in. (1,029 mm)	501 lb. (227 kg)
			CC/DC	Stick/TIG	40-250 A	250 A at 25 V, 100% duty cycle			
			CV/DC	MIG/FCAW	17-28 V	275 A at 25 V, 60% duty cycle 250 A at 28 V, 100% duty cycle			
Diesel	Bobcat 250 Diesel	(907565) Kubota with GFCI	CC/AC	Stick/TIG	40-250 A	250 A at 25 V, 100% duty cycle	Single-phase Peak: 11,000 watts Continuous: 9,500 watts	H: 28 in. (711 mm) H: 34.375 in. (873 mm) to top of exhaust W: 20 in. (508 mm) D: 45.375 in. (1,153 mm)	638 lb. (289 kg)
			CC/DC	Stick/TIG	40-250 A	250 A at 25 V, 100% duty cycle			
			CV/DC	MIG/FCAW	17-28 V	275 A at 25 V, 60% duty cycle 250 A at 28 V, 100% duty cycle			

Trailblazer® Series Gas, LP and Diesel

See lit. ED/4.75 (Gas/LP) and ED/4.8 (Diesel)



See page 121

Trailblazer 325 EFI with optional Excel power shown.

IMPROVED! Now with ArcReach technology standard on most models (see page 77 chart).

Trailblazer welder/generators deliver unbeatable arc performance providing the smoothest, most stable arc in the industry. Trailblazer-exclusive Auto-Speed™ technology (now with 1,800 rpm level on diesel model) delivers superior runtimes, increased fuel efficiency, and improved welder/generator performance.

ArcReach® remote control technology

Standard on most models (see page 77 chart) – remote control of the power source without a control cord.



An ArcReach system allows you to change weld settings from your ArcReach feeder or remote, saving a trip to the power supply. ArcReach technology uses the existing weld cable to communicate welding control information between the feeder or remote and the power source. This technology eliminates the need for control cords, and their associated problems and costs. Learn more at MillerWelds.com/arcreach

Unbeatable arc performance

Dynamic DIG™ technology automatically adjusts the amount of current required to clear a short. Delivers a smoother, more consistent arc that can be tailored to match the application, material, fit-up and welder technique.



Increased performance at high altitude

Electric fuel pumps are now standard on all EFI models leading to better performance when operating at altitudes of 5,000 feet or greater.

More productive jobsites

Quieter jobsites are more productive because work crews can communicate easier, and work can start earlier and end later – even in noise-sensitive areas.

Auto-Speed™ technology

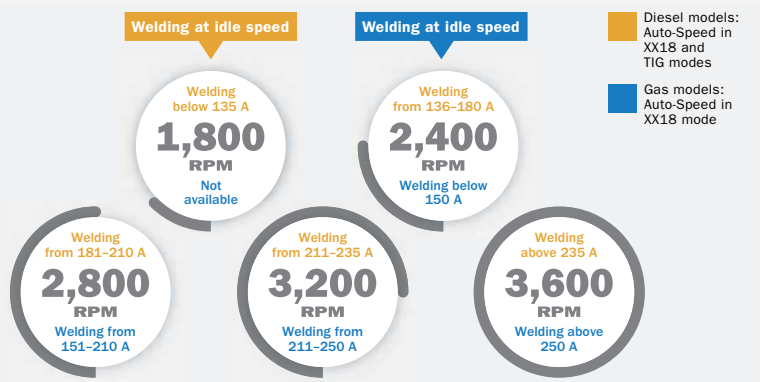

Get the welding power you need – plus reduced fuel consumption and lower noise levels for a more profitable jobsite. Trailblazer-exclusive Auto-Speed technology responds to weld requirements by automatically adjusting engine speed to a corresponding rpm level so the engine never works harder than necessary. Refueling time and operating costs are reduced, which means more productivity and profitability. Auto-Speed technology – available only from Miller.

Options to Maximize Your Trailblazer 325 Performance

Electronic fuel injection EFI (gas models)

Adding EFI to your Trailblazer welder/generator adds multiple benefits. With EFI, you'll get faster, more-reliable starts in any weather – no choke adjustments needed. EFI-equipped Trailblazer machines are also up to 42 percent more fuel efficient than standard carbureted models, improving profitability. Plus, refueling less frequently means you'll spend more of your time welding, improving productivity.

Add Excel power to your Trailblazer with EFI for maximum fuel-efficiency.

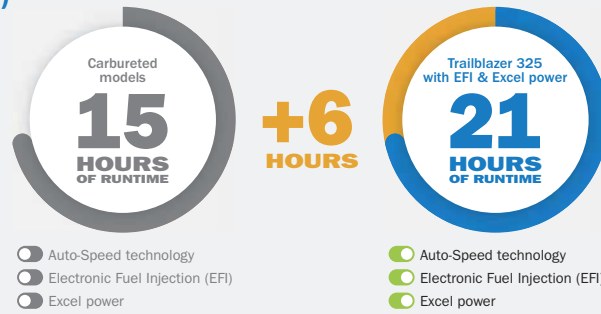

Based on typical usage – 150 amps welding 40% of the time; 20 amps generator power 30% of the time; and idling without load 30% of the time.

Excel™ power

Excel power delivers a full 2,400 watts (20 A) of 120-volt inverter-based, pure sine wave power at all speeds, including idle. Unlike competitive machines that provide auxiliary power only at 3,600 rpm (max), with Excel power you can operate jobsite tools like grinders at quiet, fuel-saving speeds.

Refueling time and operating costs are reduced with Excel power, which means more productivity and profitability. Plus everyone on the jobsite gets a better working environment because noise levels and exhaust emissions are lowered. Excel power – available only from Miller.

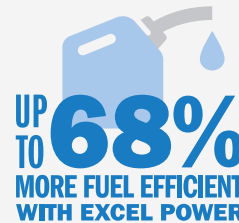

Battery charge/crank assist (option on gas models)

Reduce downtime with battery charge/crank assist capability. Designed and recommended for mechanics or anyone responsible for a fleet of trucks or equipment. By using your Trailblazer to charge dead batteries or jump a stubborn engine, you'll keep your crew working and the fleet up and running. Provides up to 75 amps of DC current to quickly charge 12- and 24-volt batteries. Jobsite equipment with weak batteries can get up to 350 amps of crank assist.

Note: Battery charge/jump cables (300422) must be ordered separately.

Heavy industrial

Processes

- Stick (SMAW) • MIG (GMAW)¹
- Flux-cored (FCAW)¹ • DC TIG (GTAW)²
- RMD³ • Pulsed MIG (GMAW-P)³
- Air carbon arc cutting and gouging (CAC-A) (rated 3/16 in. carbons)

¹ With wire feeder.

² Two-piece TIG torch recommended.

³ ArcReach models only with ArcReach Smart Feeder.

Engines

Gas: Kohler CH730

23.5 hp at 3,600 rpm

EFI gas: Kohler ECH730

23 hp at 3,600 rpm

LP: Kohler CH730LP

23.5 hp at 3,600 rpm

Twin-cylinder, four-cycle, overhead valve, industrial, air-cooled

EPA Tier 4 Final Diesel: Kubota D902

24.8 hp at 3,600 rpm

Three-cylinder, industrial, liquid-cooled

Note: Engines are warranted separately by engine manufacturer.

Most popular accessories

- SuitCase® Feeders (pg 18/46)
- ArcReach® Smart Feeder 951733 (pg 18/46) (for ArcReach models only)
- ArcReach® Stick/TIG Remote 301325 (pg 46) (for ArcReach models only)
- Spoolmatic® 30A/WC-24 Control 130831/137549 (pg 28/122)
- Multi-Terrain Running Gear (pg 116)
- Off-Road Running Gear (pg 116)
- Protective Cage with Cable Holders (pg 116)
- Hose and LP Tank Mounting Assembly (pg 116)
- All-Purpose Running Gear (pg 116)
- Full KVA Adapter Cord (pg 116)
- Protective Cover (pg 116)
- HWY-Mid Frame Trailer (pg 117)
- Electric Fuel Pump Kit 300976 (for gas models only)
Recommended for operation at altitudes above 5,000 feet
- 25 ft. Battery Charge/Jump Cables with Plug 300422 (for Trailblazer 325 EFI 907798004 only)

Visit MillerWelds.com or your distributor for other Miller® options and accessories.

*Electric fuel pump recommended for operation at altitudes above 5,000 feet.

**For LP models order Hose and LP Tank Mounting Assembly (300917) separately.

	Model	Stock Number	Welding Mode	Welding Process	Amp/Volt Ranges	Rated Output at 104°F (40°C)	Single-Phase Generator Power at 104°F (40°C)	Dimensions	Net Weight
Gas or LP	Trailblazer 325	ArcReach-equipped models (907797) Kohler (907797001) Kohler with GFCI (907797002) Kohler with GFCI and electric fuel pump* (907798) EFI Kohler (907798002) EFI Kohler with Excel power (907775001**) Liquid LP Kohler with GFCI and Excel power Non-ArcReach models (907798004) EFI Kohler w/Excel power and battery charge/crank assist (907775**) Liquid LP Kohler with GFCI	CC/DC	Stick/TIG	10-325 A (Gas) 10-305 A (LP)	325 A at 28 V, 100% duty cycle (Gas) 305 A at 28 V, 100% duty cycle (LP)	Peak: 12,000 watts 10,500 watts (LP) Continuous: 10,500 watts 10,000 watts (LP)	H: 28 in. (711 mm) H: 32.75 in. (832 mm) to top of exhaust W: 20 in. (508 mm) D: 40.5 in. (1,029 mm)	Gas: 460 lb. (209 kg) LP: 475 lb. (215 kg)
			CV/DC	MIG/FCAW	10-35 V				
Diesel	Trailblazer 325 Diesel	ArcReach-equipped models (907799) Kubota (907799001) Kubota with GFCI (907799002) Kubota with GFCI and Excel power	CC/DC	Stick/TIG	10-325 A	325 A at 33 V, 100% duty cycle	Excel power (optional) 2,400 watts 20 A at 120 V, 60 Hz pure generator power at idle speed and while welding.	H: 28 in. (711 mm) H: 34.5 in. (876 mm) to top of exhaust W: 20 in. (508 mm) D: 45.5 in. (1,156 mm)	620 lb. (281 kg)
			CV/DC	MIG/FCAW	10-35 V	325 A at 33 V, 100% duty cycle			

Trailblazer® 302 Air Pak™ See literature ED/4.78

Powerful all-in-one tool designed for repair and construction with multiprocess weld quality, generator power, air compressor and battery charge/crank assist.



Superior arc performance. Preset DIG settings optimized for the majority of stick welding applications, best-in-class wire arc performance, and two Lift-Arc™ TIG modes for most DC TIG applications.

Strongest combined generator/compressor power. Delivers an industry-leading 13,000 watts of peak generator power independent of weld settings – can power a Spectrum® 875 plasma cutter, and provide air for plasma cutting at the same time (rated 1/2-inch mild steel).

Rotary screw air compressor. Delivers up to 31 cfm and 160 psi with no storage tank and runs many tools at idle speed. Provides 100 percent deliverable air, rated at an industry-high 104 degrees Fahrenheit. Front panel adjustment and automatic overpressure shutdown with indication. 30,000-hour life expectancy and warranted for three years by Miller.

Battery charge/crank assist. Provides selectable 12- or 24-volt battery charging with up to 450 amps of battery crank assist capability. Convenient front panel access.

Note: Battery charge/jump cables (300422) must be ordered separately.



See page 121

*Electric fuel pump recommended for operation at altitudes above 5,000 feet.

Heavy industrial

Processes

- AC/DC stick (SMAW)
- MIG (GMAW)¹ ■ Flux-cored (FCAW)¹
- AC²/DC³ TIG (GTAW)
- Air carbon arc cutting and gouging (CAC-A) (rated 3/16 in. carbons, capable 1/4 in. carbons)

¹ With wire feeder.

² With Dynasty® 210 Series.

³ Two-piece TIG torch recommended.

Gasoline engine

Kohler CH750: 27 hp at 3,600 rpm V-twin-cylinder, four-cycle, overhead valve, industrial, air-cooled

Note: Engine is warranted separately by engine manufacturer.

Most popular accessories

- SuitCase® Feeders (pg 18)
- Spoolmatic® 30A/WC-24 Control 130831/137549 (pg 28/122)
- 25 ft. Battery Charge/Jump Cables with Plug 300422

Visit MillerWelds.com or your distributor for other Miller® options and accessories.

Stock Number	Welding Mode	Welding Process	Amp/Volt Ranges	Rated Weld Output at 104°F (40°C)	Single-Phase Generator Power at 104°F (40°C)	Dimensions	Net Weight
(907549) Kohler with GFCL and electric fuel pump*	CV/DC	MIG/FCAW	13-35 V, 350 A	300 A at 32 V, 100% duty cycle 350 A at 32 V, 60% duty cycle			
(907549003) Kohler with GFCL, cooler/separators and electric fuel pump*	CC/AC	Stick/TIG	10-225 A	200 A at 25 V, 60% duty cycle			

Air Compressor	Features	Free Air Delivery	Working Pressure Constant	Duty Cycle	Oil Capacity
	Rotary screw with electric clutch for on/off, oil change intervals of 500 hours	31 cfm (0.88 m ³ /min.) at 3,600 rpm 28 cfm (0.79 m ³ /min.) at 3,000 rpm 22 cfm (0.62 m ³ /min.) at 2,400 rpm (idle)	80-160 psig	100%	1.75 qt. (1.7 L)

Big Blue® 400 Pro See literature ED/5.7

The professional welder's choice – designed with the professional in mind, the Big Blue 400 Pro is the best for ease of use, reliability and fuel economy.



ArcReach® Available on select models. Remote control of the power source without a control cord. See page 76 for more information.

Dynamic DIG™ technology automatically adjusts the amount of current required to clear a short. Delivers a smoother, more consistent arc that can be tailored to match the application, material, fit-up and welder technique.



Industrial USB port. Quickly upload the latest software and download machine log files to retrieve in-depth information such as diagnostics and machine statistics.

10,000 watts of pure generator power. Plug in an extra Miller® inverter-based power source for an additional welding arc!

Quiet operation. Only 71.6 decibels (96 Lwa) under full load. Improves jobsite communication and safety.

Standard features include digital meters with SunVision™, automatic idle, adjustable Hot Start™ output contactor control and 120-volt block heater.

Heavy industrial

Processes

- Stick (SMAW) ■ MIG (GMAW)¹
- Flux-cored (FCAW)¹ ■ DC TIG (GTAW)
- RMD®² ■ Pulsed MIG (GMAW-P)²
- Air carbon arc cutting and gouging (CAC-A) (rated 3/16 in. carbons)

¹ With wire feeder.

² ArcReach models only with ArcReach Smart Feeder.

Diesel engines

EPA Tier 4 Final choices

Caterpillar C1.5T: 24.7 hp at 1,800 rpm Turbo-charged, three-cylinder, industrial, liquid-cooled

Kubota V150S: 20.2 hp at 1,800 rpm Four-cylinder, industrial, liquid-cooled

Mitsubishi S4L2: 24.7 hp at 1,800 rpm Four-cylinder, industrial, liquid-cooled

Note: Engines are warranted separately by engine manufacturer.

Most popular accessories

- SuitCase® Feeders (pg 18/46)
- ArcReach® Smart Feeder (pg 18/46)³
- ArcReach® Stick/TIG Remote (pg 46)³
- Protective Cover 195301 (pg 116)

³ For ArcReach models only.

Visit MillerWelds.com or your distributor for other Miller® options and accessories.

Stock Number	Welding Mode	Welding Process	Amp/Volt Ranges	Rated Output at 104°F (40°C)	Single-Phase Generator Power at 104°F (40°C)	Dimensions	Net Weight
(907774001) CAT with ArcReach							
(907732) Kubota	CV/DC	MIG/FCAW	14-40 V				
(907732001) Kubota with ArcReach							
(907733) Mitsubishi							
(907733001) Mitsubishi with ArcReach							

Big Blue® 400 PipePro®

See literature ED/5.8

Designed for the transmission pipeline welder – the Big Blue 400 PipePro offers superior downhill stick arc characteristics, as well as MIG/flux-cored capabilities, to meet high-strength steel requirements for the most demanding pipeline jobs.



See page 121. Wireless antenna kit (300749) recommended.

ArcReach®

Standard on all models. Remote control of the power source without a control cord. See page 76 for more information.

Dynamic DIG™ technology automatically adjusts the amount of current required to clear a short. Delivers a smoother, more consistent arc that can be tailored to match the application, material, fit-up and welder technique.



Industrial USB port. Quickly upload the latest software and download machine log files to retrieve in-depth information such as diagnostics and machine statistics.

10,000 watts of pure generator power. Plug in an extra Miller® inverter-based power source for an additional welding arc!

Compact size and weight optimizes truck space.

LINE-X® cover provides superior impact, corrosion and abrasion protection.

Quiet operation. Only 72.1 decibels (97 Lwa) under full load. Improves jobsite communication and safety.

Standard features include ArcReach technology, digital meters with SunVision™, automatic idle, adjustable Hot Start™, output contactor control, 120-volt block heater, engine coolant temperature gauge and lift-off service door. Also available with optional stainless steel enclosure.

Heavy industrial

Processes

- Stick (SMAW) ▪ MIG (GMAW)¹
- Flux-cored (FCAW)¹ ▪ DC TIG (GTAW)
- RMD² ▪ Pulsed MIG (GMAW-P)²
- Air carbon arc cutting and gouging (CAC-A) (rated 1/4 in. carbons)

¹With wire feeder.

²With ArcReach Smart Feeder.

Diesel engines

EPA Tier 4 Final choices

Caterpillar C1.5T: 24.7 hp at 1,800 rpm Turbo-charged, three-cylinder, industrial, liquid-cooled

Mitsubishi S4L2: 24.7 hp at 1,800 rpm Four-cylinder, industrial, liquid-cooled

Note: Engines are warranted separately by engine manufacturer.

Most popular accessories

- SuitCase® Feeders (pg 18/46)
- ArcReach® Smart Feeder (pg 18/46)
- ArcReach® Stick/TIG Remote (pg 46)
- Dynasty® 210 Series (pg 54)
- Full KVA Adapter Cord 300517 (pg 116)
- Single-Phase Full KVA Plug Kit 119172 (pg 116)
- Protective Cover 195301 (pg 116)
- HWY-Mid Frame Trailer (pg 117)
- Wireless Remote Hand Control/Wireless Antenna Kit 300430/300749 (pg 121)

Visit MillerWelds.com or your distributor for other Miller® options and accessories.

Diesel	Stock Number	Welding Mode	Welding Process	Amp/Volt Ranges	Rated Output at 104°F (40°C)	Single-Phase Generator Power at 104°F (40°C)	Dimensions	Net Weight
	(907778) CAT	CC/DC	Stick/TIG	20-400 A	300 A at 32 V, 100% duty cycle 350 A at 27 V, 100% duty cycle	Peak: 12,000 watts Continuous: 10,000 watts	H: 32 in. (813 mm) W: 26.25 in. (667 mm) D: 56 in. (1,422 mm)	CAT: 1,038 lb. (471 kg) Mitsubishi: 993 lb. (450 kg)
(907778001) CAT w/stainless steel	CV/DC	MIG/FCAW	14-40 V	400 A at 24 V, 100% duty cycle				
(907703001) Mitsubishi								
(907703) Mitsubishi w/stainless steel								

Big Blue® 450 Duo CST™

See literature ED/5.5

Durable dual-operator welder/generator delivers proven CST 280 stick/TIG performance for maximum productivity and efficiency. Two separate outputs powered by one low-speed diesel engine delivers up to 280 amps of output per operator.



See page 121. Wireless antenna kit (300749) recommended.

Two superior arcs in one compact package. See CST 280 (page 50) for additional details.

Quiet operation. At 72.1 decibels (97 Lwa) under full load, it's quieter than most single-operator models. Improves jobsite communication and safety.

Vandalism lockout kit (not shown). Lockable hinged steel panel protects front control and ignition switch.

Simple-to-operate **process selector knob** automatically sets proper **DIG setting** on E6010 and E7018 electrodes, providing superior stick performance.

Lift-Arc™ start for TIG starts without the use of high frequency.

Remote amperage control permits the use of standard and wireless amperage control devices.

Increased efficiency. More arcs and better fuel economy equal increased profits for your business. Estimated savings are 34 percent with a dual-operator unit versus two single-operator units.

Heavy industrial

Processes

- Stick (SMAW) ▪ DC TIG (GTAW)
- Air carbon arc cutting and gouging (CAC-A) (rated 3/16 in. carbons)

Diesel engine

EPA Tier 4 Final

Mitsubishi S4L2: 24.7 hp at 1,800 rpm Four-cylinder, industrial, liquid-cooled

Note: Engine is warranted separately by engine manufacturer.

Most popular accessories

- Full KVA Adapter Cord 300517 (pg 116)
- Single-Phase Full KVA Plug Kit 119172 (pg 116)
- Protective Cover 195301 (pg 116)
- HWY-Mid Frame Trailer 301438 (pg 117)
- Wireless Remote Hand Control/Wireless Antenna Kit 300430/300749 (pg 121)
- Spark Arrestor Kit 195012

Visit MillerWelds.com or your distributor for other Miller® options and accessories.

Diesel	Stock Number	Process	Output Mode	Amperage Range	Rated Output at 122°F (50°C)	Single-Phase Generator Power at 122°F (50°C)	Dimensions	Net Weight
	(907477) Mitsubishi	DC stick/TIG	Separate (dual outputs)	5-225 (each side) 5-280 (one side only)	175 A at 27 V, 100% duty cycle	Continuous: 10,000 watts	H: 32 in. (813 mm) W: 26.25 in. (667 mm) D: 56 in. (1,422 mm)	1,064 lb. (483 kg)
		Paralleled (combined)	10-450	350 A at 27 V, 100% duty cycle				

Big Blue® 500 Pro and 600 Series

See literature ED/11.0 (500) and ED/11.5 (600)

Clean, quiet, multiprocess machines designed to give welders the output they need for heavy-duty applications on construction and fabrication sites.



Big Blue 500 and 600 Pro

ArcReach®

Standard on all Deluxe and Air Pak™ models. Remote control of the power source without a control cord. See page 76 for more information.



See page 121. Wireless antenna kit (300749) recommended.

Electronic engine display simultaneously displays fuel level, engine hours, coolant temperature, oil pressure, battery volts, and engine rpm. Also tracks oil change intervals and displays engine diagnostics for easier servicing.



Dynamic DIG™ technology automatically adjusts the amount of current required to clear a short. Delivers a smoother, more consistent arc that can be tailored to match the application, material, fit-up and welder technique.



Industrial USB port. Quickly upload the latest software and download machine log files to retrieve in-depth information such as diagnostics and machine statistics.

20,000 watts of pure generator power. Plug in extra Miller® inverter-based power sources for additional welding arcs!

Standard features include digital meters with SunVision™ adjustable Hot Start™, output contactor control, automatic idle, thermal overload protection and 120-volt block heater.

Deluxe and Air Pak models add ArcReach, a polarity reversing switch and a vandalism lockout kit (protects control panel and receptacles).

Ingersoll Rand ultra-reliable industrial rotary screw compressor (Air Pak model only). 30,000-hour life expectancy. Independent on/off control for applications not requiring compressed air – allows greater fuel savings and longer compressor service intervals.

Heavy Industrial ● CC CV DC

Processes

- Stick (SMAW) ▪ MIG (GMAW)¹
- Flux-cored (FCAW)¹ ▪ DC TIG (GTAW)
- RMD^{®2} ▪ Pulsed MIG (GMAW-P)²
- Air carbon arc cutting and gouging (CAC-A) (500: rated 5/16 in. carbons; 600: rated 3/8 in. carbons)

¹With wire feeder.

²ArcReach models only with ArcReach Smart Feeder.

Diesel engines

EPA Tier 4 Final choices

500 and 600 Pro: Kubota V2403

48.9 hp at 1,800 rpm
Turbo-charged, four-cylinder, industrial, liquid-cooled

600 Air Pak: Deutz TD2.9 L4

65.7 hp at 1,800 rpm
Turbo-charged, four-cylinder, industrial, liquid-cooled

Note: Engines are warranted separately by engine manufacturer.

Most popular accessories

- SuitCase® Feeders (pg 18/46)
- ArcReach® Smart Feeder (pg 18/46) (for ArcReach models only)
- ArcReach® Stick/TIG Remote (pg 46) (for ArcReach models only)
- Dynasty 210® Series (pg 54)
- Full KVA Adapter Cord (pg 116)
- Full KVA Plug Kit (pg 116)
- Protective Cover (pg 116)
 - 301495 Kubota
 - 301113 Deutz
- HWY-225 Trailer 301338 (pg 117)
- Wireless Remote Hand Control/ Wireless Antenna Kit 300430/300749 (pg 121)
- Desiccant Air Dry System (for Air Pak model only)
 - 195117 Side mount
 - 195117001 Rear mount
- Eliminates moisture in the air stream and prevents air line freeze-ups in cold climates
- Cold Weather Kit 301482
- Spark Arrestor Kit 195012

Visit MillerWelds.com or your distributor for other Miller® options and accessories.

*Big Blue 600 Series has welder truck specific models available – visit MillerWelds.com or your distributor.

Model/Stock Number	Welding Mode/Process	Amp/Volt Ranges	Rated Output at 104°F (40°C)	Generator Power at 104°F (40°C)	Dimensions	Net Weight
Big Blue 500 Pro (907736) Kubota (907736001) Kubota Deluxe model	CC/DC (Stick/TIG)	20-500 A	400 A at 36 V, 100% duty cycle 450 A at 38 V, 100% duty cycle 500 A at 40 V, 100% duty cycle	Three-phase Peak: 27,000 watts Continuous: 20,000 watts Single-phase Peak: 15,000 watts Continuous: 12,000 watts	H: 46 in. (1,168 mm) W: 28.5 in. (724 mm) D: 69.5 in. (1,765 mm)	1,750 lb. (794 kg)
	CV/DC (MIG/FCAW)	14-50 V				
Big Blue 600 Pro (907737) Kubota (907737001) Kubota Deluxe model Big Blue 600 Air Pak (907750) Deutz	CC/DC (Stick/TIG)	20-600 A	600 Pro: 500 A at 40 V, 100% duty cycle 550 A at 42 V, 60% duty cycle 600 A at 42 V, 40% duty cycle	Three-phase Peak: 27,000 watts Continuous: 20,000 watts Single-phase Peak: 15,000 watts Continuous: 12,000 watts	H: 46 in. (1,168 mm) W: 28.5 in. (724 mm) D: 69.5 in. (1,765 mm)	600 Pro: 1,750 lb. (794 kg) 600 Air Pak: 2,040 lb. (925 kg)
	CV/DC (MIG/FCAW)	14-50 V	600 Air Pak: 500 A at 40 V, 100% duty cycle 575 A at 43 V, 100% duty cycle 600 A at 44 V, 60% duty cycle			
Ingersoll Rand CE55 G1 Air Compressor (Air Pak model only)	Features	Free Air Delivery	Working Pressure Constant	Duty Cycle	Oil Capacity	
	Rotary screw with electric clutch for on/off, oil change intervals of 500 hours, life expectancy of 30,000 hours	Idle: 40 cfm (1.13 m ³ /min.) Weld: 60 cfm (1.70 m ³ /min.)	100 psig (7 bar)	100%	4 qt. (3.79 L)	

Big Blue® 800 Series See literature ED/14.0

The most powerful lineup of diesel welder/generators in the industry. All offer robust output for welding and power generation, and are ideal for dual-operator applications on labor intensive jobsites or jobsites with limited space.



Big Blue 800 Duo Pro

Big Blue 800 Duo Air Pak

Multi-arc welding. One dependable engine – two independent arcs with up to 400 amps each. Or plug in additional inverters for a true multioperator work platform! Example: Two additional XMT machines equals four operators, up to 200 amps each. Premium quality arcs allow operators to work independently with no arc interaction. Multioperator welding has never been easier or more versatile.

Increased efficiency. More arcs and better fuel economy equal increased profits for your business. Estimated savings are 34 percent with a dual-operator unit versus two single-operator units.

Simple paralleling switch makes switching from a single operator to dual operators a breeze. Weld up to 400 amps per side when set up in dual-operator mode, or up to 800 amps in single-operator mode.

Electronic engine display simultaneously displays fuel level, engine hours, coolant temperature, oil pressure, battery volts and engine rpm. Also tracks oil change intervals and displays engine diagnostics for easier servicing. Air Pak model adds air pressure and compressor hours displays.



*Big Blue 800 Duo Air Pak has welder truck specific models available – visit MillerWelds.com or your distributor.

ArcReach®

Standard on all models.
Remote control of the power source without a control cord.
See page 76 for more information.



See page 121.
Wireless antenna kit (300749) recommended.

Dynamic DIG™ technology automatically adjusts the amount of current required to clear a short. Delivers a smoother, more consistent arc that can be tailored to match the application, material, fit-up and welder technique.



Industrial USB port. Quickly upload the latest software and download machine log files to retrieve in-depth information such as diagnostics and machine statistics.

20,000 watts of pure generator power. Plug in extra Miller® inverter-based power sources for additional welding arcs!

Standard features include ArcReach technology, digital meters with SunVision™, automatic idle, 120-volt block heater and vandalism lockout kit (protects control panel and receptacles).

Ingersoll Rand ultra-reliable industrial rotary screw compressor (Air Pak™ model only). 30,000-hour life expectancy. Independent on/off control for applications not requiring compressed air – allows greater fuel savings and longer compressor service intervals.

Heavy industrial

Processes

- Stick (SMAW) ▪ MIG (GMAW)¹
- Flux-cored (FCAW)¹ ▪ DC TIG (GTAW)
- RMD² ▪ Pulsed MIG (GMAW-P)²
- Air carbon arc cutting and gouging (CAC-A) (rated 1/2 in. carbons)
- Stud (1/2 in.)

¹With wire feeder.

²With ArcReach Smart Feeder.

Diesel engine

EPA Tier 4 Final

Deutz TD2.9 L4: 65.7 hp at 1,800 rpm
Turbo-charged, four-cylinder, industrial, liquid-cooled

Note: Engines are warranted separately by engine manufacturer.

Most popular accessories

- SuitCase® Feeders (pg 18/46)
- ArcReach® Smart Feeder (pg 18/46)
- ArcReach® Stick/TIG Remote (pg 46)
- Dynasty 210® Series (pg 54)
- Full KVA Adapter Cord 300517 (pg 116)
- Full KVA Plug Kit (pg 116)
 - 119172 Single-phase
 - 254140 Three-phase
- Protective Cover 301113 (pg 116)
- HWY-225 Trailer 301338 (pg 117)
- Wireless Remote Hand Control/Wireless Antenna Kit 300430/300749 (pg 121)
- Desiccant Air Dry System (Air Pak model only)
 - 195117 Side mount
 - 195117001 Rear mount
 Eliminates moisture in the air stream and prevents air line freeze-ups in cold climates
- Cold Weather Kit 301482
- Spark Arrestor Kit 195012

Visit MillerWelds.com or your distributor for other Miller® options and accessories.

Diesel	Model/Stock Number*	Welding Mode/Process	Output Mode	Amp/Volt Ranges	Rated Output at 100% Duty Cycle at 104°F (40°C)	Generator Power at 104°F (40°C)	Dimensions	Net Weight
	Big Blue 800 Duo Pro (907751) Deutz	CC/DC (Stick/TIG)	Separate (dual outputs)	20-400 A	400 A at 36 V (each side)	Three-phase Peak: 27,000 watts Continuous: 20,000 watts	H: 46 in. (1,168 mm) W: 28.5 in. (724 mm) D: 69.5 in. (1,765 mm)	Duo Pro: 1,869 lb. (848 kg) Duo Air Pak: 2,095 lb. (968 kg)
Big Blue 800 Duo Air Pak (907752) Deutz	CV/DC (MIG/FCAW)	Separate (dual outputs)	14-50 V	400 A at 34 V (each side)	Single-phase Peak: 15,000 watts Continuous: 12,000 watts			
		Paralleled (combined)	40-800 A	700 A at 44 V, 800 A at 38 V				
		Paralleled (combined)	14-50 V	750 A at 40 V, 800 A at 38 V				
Ingersoll Rand CE55 G1 Air Compressor (Air Pak model only)	Features	Free Air Delivery	Working Pressure Constant	Duty Cycle	Oil Capacity			
	Rotary screw with electric clutch for on/off, oil change intervals of 500 hours, life expectancy of 30,000 hours	Idle: 40 cfm (1.13 m ³ /min.) Weld: 60 cfm (1.70 m ³ /min.)	100 psig (7 bar)	100%	4 qt. (3.79 L)			



Submerged Arc

For more detailed information, visit



MillerWelds.com/subarc

Miller offers an array of versatile submerged arc components, including power sources, controls, wire drives, torches, tractors and a variety of other accessories.

SubArc Digital Series

See literature AD/7.3

The SubArc Digital Series of power sources, interface controls and accessories include digital control and communication electronics designed to improve weld performance and simplify the integration of the equipment in more advanced applications.



SubArc DC 650 Digital

SubArc DC 1000 Digital

SubArc AC/DC Digital

Two DC power source models and one AC/DC power source model. Power sources have sufficient power capacity to cover applications from traditional DC single-arc to multi-wire tandem welding. In the case of electroslag welding or other high-current demand, two or more power sources can easily be paralleled (both DC and AC/DC machines).

Low-voltage accessory operation and improved environmental protection. The Digital Series accessories are powered with 24 VAC control voltage from the power source. All power sources, interface controls and wire drives are IP23 rated providing a high level of protection for harsh environments.

Easy to integrate. Our SubArc power sources are easy to integrate by using a standard Modbus® connection.

All power sources feature thermal overload protection, line voltage compensation and Fan-On-Demand.™

Heavy industrial



SubArc DC Series is DC only.

Processes

- Submerged arc (SAW)
- Electroslag (ESW)
- Air carbon arc cutting and gouging (CAC-A)

Most popular accessories

- 14-pin Insight Core™ Module 301072 (pg 68)
Requires Insight Core to SubArc Digital Series Adapter Kit (301295)
- Insight ArcAgent™ Auto 301346 (pg 69)
- 15 ft. (4.6 m) SubArc Parallel Cable 260775015 (pg 119)
- 15 ft. (4.6 m) SubArc Tandem Cable 260878015 (pg 119)

Visit MillerWelds.com or your distributor for other Miller® options and accessories.

*While idling.

Model/Stock Number	Amperage Range (CC Mode)	Voltage Range (Sub Arc Mode)	Rated Output	Amps Input at Rated Output, 60 Hz					Max Open-Circuit Voltage	Dimensions (Includes lift eye, but not strain relief)	Net Weight
				230 V	460 V	575 V	KVA	KW			
SubArc DC 650 Digital (907622) 230/460/575 V	50-815 A	20-44 V	650 A at 44 V, 100% duty cycle	126 3.8*	63 1.9*	50.4 1.4*	50 1.52*	34.8 0.76*	75 Vpk	H: 30 in. (762 mm) W: 23 in. (584 mm) D: 38 in. (965 mm)	593 lb. (269 kg)
SubArc DC 1000 Digital (907624) 230/460/575 V	100-1,250 A	20-44 V	1,000 A at 44 V, 100% duty cycle	180 5.8*	90 2.9*	72 2.4*	73 3.2*	53 0.5*	68 Vpk		682 lb. (309 kg)
SubArc AC/DC Digital (907620) 460 V	300-1,250 A	20-44 V	1,000 A at 44 V, 100% duty cycle	—	122	—	98	53	93 Vpk	H: 43 in. (1,092 mm) W: 28 in. (711 mm) D: 48 in. (1,219 mm)	1,187 lb. (538 kg)

SubArc Interface Control

See literature no. AD/7.3



Easier setup and operation. The SubArc Interface Digital control recognizes the power source and wire drive connected, and automatically configures the system for proper operation.

Internal terminal strip is able to integrate with positioners, sidebeams, turning rolls and other peripheral equipment.

Most popular accessories

- SubArc Control Cables (pg 119)
 - 260622030 30 ft. (9.1 m)
 - 260622050 50 ft. (15 m)
 - 260622060 60 ft. (18.3 m)
 - 260622080 80 ft. (24.4 m)
 - 260622100 100 ft. (30.5 m)
 - 260622120 120 ft. (36.6 m)
 - 260622200 200 ft. (61.0 m)

Visit MillerWelds.com or your distributor for other Miller® options and accessories.

Stock Number	Input Power from Welding Power Source	Welding Power Source Type	Weld Voltage and Amperage Capacity	Dimensions	Net Weight
SubArc Interface Digital (300936)	24 VAC, 1-phase, 25 A, 50/60 Hz	Constant voltage (CV), AC or DC, with remote contactor and output control capabilities	0-100 V 0-1,500 A	H: 11.5 in. (292 mm) W: 12 in. (305 mm) D: 7 in. (178 mm)	15.8 lb. (7.2 kg)

SubArc Remote Operator Interface

See literature AD/7.3



Motor Control Digital



Remote Pendant Digital

Point-of-use installation. Remote Pendant can be handheld or secured at point of use to improve operation.

Remote installation. Motor Control can be remotely installed, resulting in reduced cables at the operator workstation.

Side handles on Remote Pendant provides option for handheld operation with full functionality of a traditional SubArc Interface.

Most popular accessories

- SubArc Control Cables (see pg 119 for complete list)
 - 260622030 30 ft. (9.1 m)
 - 260622050 50 ft. (15 m)
 - 260622080 80 ft. (24.4 m)
- Continuum™ Control/Motor Cables (see pg 119 for complete list)
 - 263368015 15 ft. (4.6 m)
 - 263368025 25 ft. (7.6 m)
 - 263368050 50 ft. (15 m)

Visit MillerWelds.com or your distributor for other Miller® options and accessories.

Model/Stock Number	Input Power from Welding Power Source	Welding Power Source Type	Weld Voltage and Amperage Capacity	Dimensions	Net Weight
SubArc Motor Control Digital (301425) (requires SubArc Remote Pendant Digital below and Continuum control/motor cable)	24 VAC, 1-phase, 25 A, 50/60 Hz	Constant voltage (CV), AC or DC, with remote contactor and output control capabilities	0-100 V 0-1,500 A	H: 11.5 in. (292 mm) W: 12 in. (305 mm) D: 7 in. (178 mm)	15.8 lb. (7.2 kg)
SubArc Remote Pendant Digital (301424) (requires SubArc Motor Control Digital above and Continuum control/motor cable)	42 VDC, 1 A			H: 11 in. (279 mm) W: 10.63 in. (270 mm) D: 3.125 in. (80 mm)	3 lb. (1.4 kg)



Miller recommends



Customers count on Hobart® to provide an exceptional level of expertise and commitment in developing unique filler metal and flux solutions with them to meet current and future challenges.

Rely on Hobart for submerged arc applications and all your welding needs.

Visit HobartBrothers.com or your local distributor to learn more.

Questions? Hobart is here to help.



Submerged Arc

SubArc Wire Drive 400 Digital Low Voltage

See literature AD/7.3



SubArc Wire Drive 400 Digital Low Voltage is a standard-speed, right-angle wire drive assembly.

Most popular accessories

- Motor Extension Cables (pg 119)
 - 254232005 5 ft. (1.5 m)
 - 254232010 10 ft. (3 m)
 - 254232025 25 ft. (7.6 m)
 - 254232065 65 ft. (19.8 m)
- Drive Rolls (pg 119)
- Single-Wire Straightener 199733 (pg 119)
- Twin-Wire Straightener 301160 (for twin-wire torches only) (pg 119)
- Manual Single Slide (pg 119)

Visit MillerWelds.com or your distributor for other Miller® options and accessories.

Stock Number (300938)	Input Power 38 VDC	Input Power Cord 4 ft. (1.2 m)	Rating 1/5 hp, 85 rpm	Wire Feed Speed 30-400 ipm (0.8-10.2 m/min.)	Wire Diameter Capacity 3/32-3/16 in. (2.4-4.8 mm)	Net Weight 26 lb. (11.8 kg)
---------------------------------	------------------------------	--	---------------------------------	---	---	---------------------------------------

SubArc Torches

See literature AD/7.3



OBT 600 torch has concentric flux flow nozzle. 600 amps at 100 percent duty cycle. For use with 1/16-5/32 inch (1.6-4.0 mm) wire.

OBT 1200 torch has concentric flux flow nozzle. 1,200 amps at 100 percent duty cycle. For use with 1/16-5/32 inch (1.6-4.0 mm) wire. OBT 1200 features a replaceable breakaway adapter end to prevent costly damage should torch run into an obstruction.

1200-Amp Twin-Wire Torch (long). 1,200 amps at 100 percent duty cycle. For use with 3/64-3/32 inch (1.2-2.4 mm) wire.

Most popular accessories

- OBT 600 Torch Body Extensions (pg 119)
 - 043967 1 inch (25.4 mm)
 - 043969 2 inch (50.8 mm)
 - 043973 4 inch (101.6 mm)
 - 043975 6 inch (152.4 mm)
- OBT 1200 Torch Body Extension 043981 (pg 119)
- Contact Tips (pg 119)

Visit MillerWelds.com or your distributor for other Miller® options and accessories.

Model/Stock Number	Rated Output	Wire Diameter Capacity	Single/Twin	Torch Body Length
OBT 600 (043923)	600 A at 100% duty cycle	1/16-5/32 in. (1.6-4.0 mm)	Single	10.25 in. (260.4 mm)
OBT 1200 (043900)	1,200 A at 100% duty cycle	1/16-5/32 in. (1.6-4.0 mm)	Single	17.25 in. (438.2 mm)
1200-Amp Twin-Wire Torch (301144) Long	1,200 A at 100% duty cycle	3/64-3/32 in. (1.2-2.4 mm)	Twin	16.97 in. (431 mm)

SubArc Flux Hopper

See literature AD/7.3



Improved flux delivery system. Our SubArc Flux Hopper Digital Low Voltage utilizes a flux valve mechanism that assures continuous delivery of flux to the arc.

Sight glass allows the weld operator to visually monitor the remaining flux in the hopper.

Versatile opening is sized to allow hookup of any flux-hopper-mounted recovery system.

Includes slag screen to capture fused slag particles from entering the flux hopper.

Most popular accessories

- Flux Hopper Extension Cables (pg 119)
 - 260623010 10 ft. (3 m)
 - 260623025 25 ft. (7.6 m)
 - 260623065 65 ft. (19.8 m)

Visit MillerWelds.com or your distributor for other Miller® options and accessories.

Stock Number SubArc Flux Hopper Digital Low Voltage (300942)	Input Power 12 VDC (PWM signal from SubArc Interface)	Input Power Cord 11 ft. (3.3 m)	Flux Capacity 25 lb. (11 kg)	Net Weight 11 lb. (5 kg)
--	---	---	--	------------------------------------

SubArc 3-Wheel Tractor

See literature AD/7.7



Easy-to-use foot- or hand-operated clutch allows for easy engagement of tractor drive and disengagement to move tractor into position.

Flexible mast configuration allows torch to be positioned in multiple weld zones and adapts to your weld application.

SubArc Tractor Interface Digital provides easy-to-operate single control for power source and tractor operation.

Regulated travel speed ensures your actual and set travel speeds are consistent, improving weld quality.

Locking front wheel can be set in place to desired travel path.

Easily accommodates a 60-pound (27 kg) wire reel for fewer time-consuming wire changeovers.

Low-voltage operation and improved environmental protection. The new digital series accessories are powered with 24 VAC control voltage from the power source. All power sources, interface controls and wire drives are IP23 rated providing a high level of protection for harsh environments.

Packages include

- SubArc 3-Wheel Tractor
- SubArc Tractor Interface Digital
- SubArc Wire Drive 400 Digital Low Voltage
- 10 lb. (4.5 kg) capacity flux hopper with manual valve
- 60 lb. (27 kg) wire reel
- OBT 600 torch
- Wire straightener

Required power source

- SubArc Digital Series (pg 82)

Most popular accessories

- SubArc Control Cables (pg 119)
- Contact Tips (pg 119)
- Drive Rolls (pg 119)

Visit MillerWelds.com or your distributor for other Miller® options and accessories.

Stock Number	Input Power from Welding Power Source	Wire Feed Speed	Wire Diameter Capacity	Gun Positioning Slides	Drive Motor	Travel Speed	Dimensions	Net Weight
(951755)	24 VAC, 1-phase, 50/60 Hz, 25 A	30-400 ipm (0.8-10.2 m/min.)	1/16-5/32 in. (1.6-4.0 mm)	3.5 in. (88.9 mm)	38 VDC	5-70 ipm (0.13-1.75 m/min.)	H: 36 in. (914 mm) W: 43.25 in. (1,149 mm) D: 31.63 in. (803 mm)	120 lb. (54.4 kg) without flux or wire

SubArc Portable Welding System

See literature AD/7.6

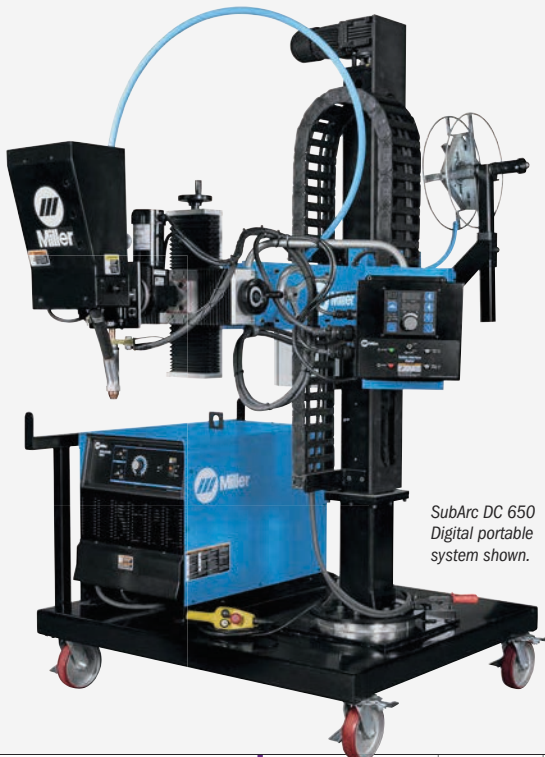

SubArc DC 650 Digital portable system shown.

Self-contained system for pressure vessel, pipe and general welding applications. Houses a power source, column and boom on a mobile platform.

Built-in fork pockets and caster wheels allow welding system to be brought to the joint.

Easy positioning of the weld head through use of integrated motorized column, manual telescoping boom, slide and 360-degree column rotation.

Motorized column with pendant control and manual telescoping boom provides 44 inches (1,117 mm) of vertical travel and 31 inches (787 mm) of horizontal travel respectively.

Manual slide provides 7.87 inches (200 mm) of fine vertical and horizontal torch adjustment.

Systems include

- Portable column and boom
- SubArc Digital power source
- SubArc Interface Digital and control cable
- SubArc Wire Drive 400 Digital Low Voltage
- 25 lb. (11.3 kg) capacity flux hopper with valve
- 60 lb. (27 kg) wire reel and support assembly
- OBT 600 torch (650 system) or OBT 1200 torch (1000 system)
- Wire straightener
- Manual slide

Most popular accessories

- 14-pin Insight Core™ Module 301072 (pg 68)
Requires Insight Core to SubArc Digital Series Adapter Kit (301295)
- Insight ArcAgent™ Auto 301346 (pg 69)
- Contact Tips (pg 119)
- Drive Rolls (pg 119)

Visit MillerWelds.com or your distributor for other Miller® options and accessories.

Stock Number	Supply Voltage	Column Stroke	Column Travel	Boom Stroke	Boom Travel	Base Rotation	Minimum Working Height	Maximum Working Height	Overall Height
(951675) w/SubArc DC 650 Digital (951676) w/SubArc DC 1000 Digital (see page 82 for power source specs)	120 V, 1-phase, 60 Hz (see page 82 for power source requirement)	44 in. (1,117 mm)	Constant speed	31 in. (787 mm)	Manual	360°	DC 650: 33.5 in. (851 mm) DC 1000: 26.25 in. (667 mm)	DC 650: 77.5 in. (1,969 mm) DC 1000: 70.25 in. (1,784 mm)	102 in. (2,590 mm)



Induction Heating

For more detailed information, visit MillerWelds.com/induction

ProHeat™ Induction Heating

Induction heating is a simple and cost-effective heating process that can deliver fast and consistent heat. Applications that would typically require hours to heat can be done in minutes.

- Welding fabrication and construction
- Preheating of welds
- Post-weld heat treatment (PWHT)
- Hydrogen bake out
- Shrink fit applications

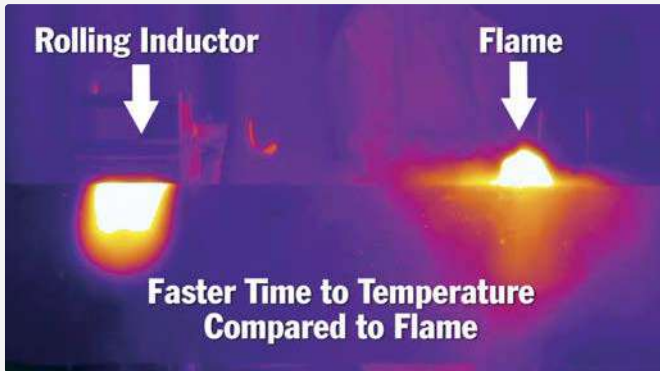

Induction heating solves many key issues in today's environment.

- Does not produce the exposure to burns associated with open flames and electrical resistance wires (only the work part becomes hot)
- No significant expense of fuel gases
- Produces less particulate from overheated insulation caused by high-temperature electrical wires and ceramic pads

Induction heating applications:

- Process piping
- Refinery
- Petrochemical
- Power piping
- Pressure vessels
- Structural
- Shipbuilding
- Pipeline

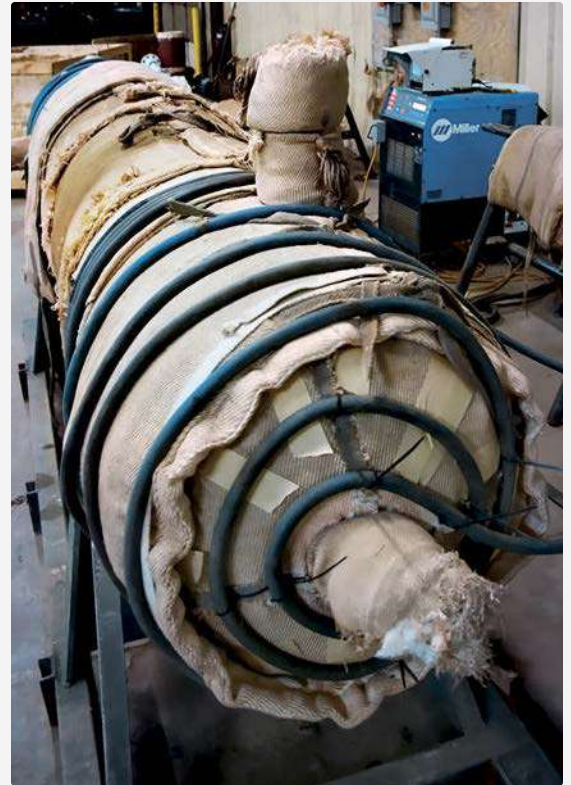

For more information:

Call **1-844-IND-HEAT (1-844-463-4328)**
or email InductionSales@MillerWelds.com

ProHeat 35 Power Source

The ProHeat 35 induction power source is equipped with a built-in temperature controller allowing for manual or temperature-based programming using up to four control thermocouples. At more than 90 percent efficiency, the ProHeat 35 power source transfers more energy to the part, reducing operating costs over different heating methods.

Digital Recorder (optional)

The digital recorder is commonly used in stress relieving and critical preheat applications. The recorder stores temperature data based on time. It is not required to perform successful heating applications.

Heavy-Duty Induction Cooler (optional)

Optimized for induction heating applications, cooler features a 2.5-gallon rustproof polyethylene tank, high-pressure pump, and blower to yield a high cooling capacity.



ProHeat 35 power source shown with optional heavy-duty induction cooler, running gear and digital recorder.

Note: Primary input cable is not included with power source.

One ProHeat™ System – Four Basic Induction Heating Configurations

ProHeat 35 induction heat systems solve preheating, post weld heat treatment (PWHT) and stress relieving problems.

Liquid-Cooled Cables See literature IN/15.0

Preheat applications up to 1,450 degrees Fahrenheit (788°C).

- A highly versatile tool for preheating, stress relieving, hydrogen bake out, post weld heat treatment and shrink fit in a variety of pipe diameters and flat plate
- Designed with flexibility in mind, the ProHeat liquid-cooled induction heating cables can be wrapped into coils of various shapes and sizes to fit almost any induction heating application



Liquid-Cooled Rolling See literature IN/13.0

Preheat of moving parts up to 600 degrees Fahrenheit (315°C).

- Ideal for preheating rolling pipe and moving parts, with easy and time-saving setup and movement for maintaining and adhering to preheat and interpass temperatures
- Enables the benefits of rolled pipe welding while also addressing some of the concerns associated with other popular heating methods, such as open flame and resistance heating
- *Optional* infrared temperature sensor can read the temperature on the moving part – from 212 to 750 degrees Fahrenheit (100–400°C)
- *Optional* travel detect system can be used for setting different heating rates/ ramps based on workpiece speed travel – when no movement is detected the system turns off the output preventing damage to workpiece and rolling inductor



Air-Cooled Blankets See literature IN/14.0

Preheating applications up to 400 degrees Fahrenheit (204°C).

- Air-cooled blankets are available for pipe diameters from 8–60 inches (20–152 cm) or in the case of plate, the lengths are 41–205 inches (1–5.2 m)
- The blankets easily conform to circular and flat parts and install in a matter of seconds
- Manufactured from durable high-temperature materials, flexible induction blankets are designed to withstand the tough conditions in both industrial and construction applications



Air-Cooled Cables See literature IN/14.0

Preheating applications up to 392 degrees Fahrenheit (200°C).

- Air-cooled cables are available in lengths of 30 foot (9.1 m), 50 foot (15.2 m) or 80 foot (24.4 m) for flexible configurations
- Designed with flexibility and efficiency in mind, the air-cooled cables can be wrapped into coils of various shapes and sizes to fit almost any induction preheating application, without the need for cooler and coolant
- Air-cooled cables provide the same flexibility as liquid-cooled cables for preheating



Engineered for Simplicity. Built for Durability.

Your welders select the Bernard gun handles, triggers and necks that are **the most comfortable and effective** for accessing their welds.

Management enjoys the resulting **increase in productivity, longer gun life, and a reduced parts inventory** with consumables designed to work across all of your welding guns.

For more information see pages 25-26, or contact your local welding distributor or Bernard directly.



BernardWelds.com

1-855-MIGWELD (644-9353)



Maximizing throughput. Minimizing costs.

Automated welding applications require flexible, repeatable solutions that **maximize production uptime and throughput while minimizing costs**. This is why industrial manufacturers rely on Tregaskiss and its proven track record of delivering **reliable and resilient robotic MIG welding guns and peripherals**. See pages 34-35 for more information.



Visit Tregaskiss.com to configure a robotic gun for your welding application today.
Or call 1-855-MIGWELD (644-9353) for more information.



For more detailed information, visit

MillerWelds.com/plasmacutters

Plasma Cutters



Product Guide

	Page	Class	Googling	Piercing	Rated Output/ Duty Cycle	Rated Cutting Thickness*			Max. Sever Thickness Mild Steel	Special Features	Typical Applications	
						Mild Steel	Stainless Steel	Aluminum				
Spectrum® 375 X-TREME™	90	●	●	●	30 A at 40%	3/8 in.	3/8 in.	1/4 in.	5/8 in.	Auto-Line™ (120-240 V), MVP™ plugs, Auto-Refire™, automatic air regulation, only 19 lb., XT30 torch	HVAC, maintenance, light construction, hobbyist, auto restoration, fabrication	1-Phase
Spectrum® 625 X-TREME™	90	●	●	●	40 A at 60%	5/8 in.	1/2 in.	3/8 in.	7/8 in.	Auto-Line™ (120-240 V), MVP™ adapters, Auto-Refire™, automatic air regulation, only 21 lb., XT40 torch	Maintenance, light construction, body shops, prototyping	
Spectrum® 875	90	●	●	●	60 A at 50%	7/8 in.	7/8 in.	5/8 in.	1-1/4 in.	Auto-Refire™, automatic air regulation, only 49 lb., XT60 or XT60M torch	Construction, maintenance/repair, fabrication	
Spectrum® 875 Auto-Line™	90	●	●	●	208: 60 A at 40% 230-380 V: 60 A at 50% 380-575 V: 60 A at 60%	7/8 in.	7/8 in.	5/8 in.	1-1/4 in.	Auto-Line™ (208-575 V), Auto-Refire™, automatic air regulation, only 54 lb., XT60 or XT60M torch	Construction, maintenance/repair, fabrication	1 & 3-Ph

Engine-Driven Welder/Generator	Continuous Generator Power	Spectrum 375 X-TREME Steel Cut / Output Amp Setting**	Spectrum 625 X-TREME Steel Cut / Output Amp Setting**	Spectrum 875 / 875 Auto-Line Steel Cut / Output Amp Setting**	
Fusion 160 and Blue Star® 185	6,200 watts	3/8 in. / 30 A	Not recommended	Not recommended	Cutting w/Engine Drive
Bobcat® 200 Air Pak™	5,500 watts	3/8 in. / 30 A	Not recommended	Not recommended	
Bobcat® 225, 250, 3 Phase	9,500 watts	3/8 in. / 30 A	5/8 in. / 40 A	1/2 in. / 45 A	
Trailblazer® Series	10,500 watts	3/8 in. / 30 A	5/8 in. / 40 A	1/2 in. / 45 A	
Big Blue® 400 Pro, 400 PipePro® and 450 Duo CST™	10,000 watts	3/8 in. / 30 A	5/8 in. / 40 A	1/2 in. / 45 A	
Big Blue® 500 Pro, 600 Series and 800 Series	1-phase: 12,000 watts 3-phase: 20,000 watts	3/8 in. / 30 A	5/8 in. / 40 A	7/8 in. / 50 A	

***Note on cut capacity ratings:** The Spectrum Series rating system is designed to provide a guide to help our customers choose the right machine for their application. Rated cut capacity is based on traveling approximately 15 inches per minute to achieve a steady, precise cut. This is the key rating that should meet or exceed your typical cutting thickness requirements. Sever cut is the maximum cut achieved in ideal conditions. Some factors that dictate actual cut speeds, thickness capacity and duty cycles are: types of thermally conductive material being cut, available input power, output power settings and operator technique. For highly thermal conductive metals such as aluminum, cutting capacities may be reduced up to 30 percent compared to mild steel.

Product Key Class: ● Light industrial ● Industrial ● Heavy industrial Capability: ● Designed for this process ● Capable of this process

*See note on cut capacity ratings above. **240 V, full KVA plug. Derate cut capacity with less generator power.

For more detailed information, see individual literature sheets.

Spectrum® Series Plasma Cutters

Our Spectrum line of plasma cutters provides big cutting power in portable packages and with features like flexible cables and Auto-Refire technology they are better than ever. Step up to Spectrum 625 X-TREME™ or 875/875 Auto-Line™ models to add Ultra-Quick Connect hand-held torches. Machine torch capabilities are available with Spectrum 875/875 Auto-Line™ models only.



Spectrum 375 X-TREME

Spectrum 625 X-TREME

Spectrum 875

Spectrum 875 Auto-Line

Spectrum Features

Feature	375 X-TREME	625 X-TREME	875	875 Auto-Line
Auto-Line (120-240 V)	●	●		●
Auto-Line (208-575 V)	●	●		●
MVP™ plugs/adapters	●	●		●
Ultra-Quick Connect torch with flexible cable			●	●
Quick connect flexible work cable with clamp	●	●	●	●
Built-in gas/air filter and regulator	●	●	●	●
Auto-Refire	●	●	●	●
Auto postflow	●	●	●	●
Auto air regulation	●	●	●	●
X-CASE™	●	●		●
Machine torch capable			●	●

Steel/Stainless/Aluminum Rated Cutting Capacity

Material	Spectrum 375 X-TREME	Spectrum 625 X-TREME	Spectrum 875/875 Auto-Line
Steel/Stainless	3/8 in. (9.5 mm)	5/8 in. (15.9 mm)*	7/8 in. (22.2 mm)
Aluminum	1/4 in. (6.4 mm)	3/8 in. (9.5 mm)	5/8 in. (15.9 mm)

*Stainless: 1/2 in. (12.7 mm) for Spectrum 625 X-TREME.

Cut capacity ratings are based on traveling speed of approximately 15 inches per minute to achieve a precise cut. This is the key rating that should meet or exceed your typical cutting thickness requirements. Factors that can affect actual cut speeds, thickness capacity and duty cycles are: types of thermally conductive material being cut, available input power, output power settings and operator technique. For highly thermal conductive metals such as aluminum, cutting capacities may be reduced up to 30 percent compared to mild steel.

Power factor correction (PFC). Uses less energy by utilizing input power more efficiently and increases productivity by reducing nuisance circuit breaker trips.

LED indicators for easy troubleshooting.

Non-high-frequency arc starting does not interfere with or damage controls or computers.

Postflow cooling circuitry extends life of the consumable and torch by cooling them with postflow air after trigger is released.

Auto-Refire™ provides ultimate convenience by automatically controlling the pilot arc when cutting expanded metal or multiple pieces of metal.

Automatic air regulation compensates for input pressure variation to provide constant recommended torch pressure for optimum cutting performance.

Built-in gas/air filter and regulator. Provides air filtration of airborne particles five microns and larger. Additional filtration and water separation recommended.

LVC™ line voltage compensation provides peak performance power under variable input voltage conditions for clean, steady cuts.

Wind Tunnel Technology™ prevents abrasive dust and particles from damaging internal components.

Fan-On-Demand™ cooling system only operates when needed, reducing power consumption and keeping internal components cleaner.

Quick connect flexible work cable with heavy-duty clamp.

Spectrum 625 X-TREME and 875/875 Auto-Line hand-held torches



Ultra-Quick Connect™ hand-held torches with flexible cables.

XT40 hand-held torch for Spectrum 625 X-TREME and XT60 hand-held torch for both Spectrum 875 models

feature quick torch connection, ergonomic handles to help prevent operator fatigue and flexible cables that make maneuvering easier.

Spectrum 875/875 Auto-Line machine torches



Long and short body machine torches.

XT60M machine torches for both Spectrum 875 models come in long or short body configurations in either 25- or 50-foot cable lengths. Only long body torches are available in packages, but both bodies can be ordered separately (see page 118).

Models/packages

Spectrum 375 X-TREME hand-held torch package shown.

Spectrum 875 Auto-Line long body machine torch package shown.



Model	Hand-Held Torch Packages			Long Body Machine Torch Packages	
	12 ft. (3.7 m)	20 ft. (6.1 m)	50 ft. (15.2 m)	25 ft. (7.6 m)	50 ft. (15.2 m)
Spectrum 375 X-TREME	(907529)	—	—	—	—
Spectrum 625 X-TREME	(907579)	(907579001)	—	—	—
Spectrum 875	—	(907583)	(907583001)	(907583002)	—
Spectrum 875 Auto-Line	—	(907584)	(907584001)	(907584002)	(907584004)

Spectrum® 375 X-TREME™/625 X-TREME™

See literature PC/9.2 (375 X-TREME) and PC/9.6 (625 X-TREME)

AUTO-LINE TECHNOLOGY Allows for any input voltage hookup (120–240 V, single-phase, 50/60 Hz for 375 X-TREME and 60 Hz for 625 X-TREME) with no manual linking, providing convenience in any job setting.

X-CASE™ provides the ultimate protection during transport and storage. Additional space is ideal for MVP plugs, consumables box, gloves, etc.

Multi-voltage plug (MVP™) on 375 X-TREME or MVP™ adapter on 625 X-TREME allows connection to 120- or 240-volt receptacles without tools.

Automatic gouging consumable detection (625 X-TREME only). Detects gouging consumable and adjusts gas pressure to optimize performance, eliminating the need for a manual regulator.



Spectrum 625 X-TREME shown.

375 X-TREME model includes XT30 hand-held torch with ergonomic design and flexible cable.

625 X-TREME model includes Ultra-Quick Connect™ XT40 hand-held torch with ergonomic design and flexible cable.

Spectrum® 875/875 Auto-Line™

See literature PC/9.8

AUTO-LINE TECHNOLOGY Spectrum 875 Auto-Line model allows for any input voltage hookup (208–575 V, single- or three-phase) with no manual linking, providing convenience in any job setting. *Standard Spectrum 875 model operates on 208/230 V, single-phase input voltage only.*

Consumables storage compartment provides convenient access to consumables and parts.

Machine torch capable. Both Spectrum 875 models can be ordered with a long body machine torch or can be converted to use a machine torch with optional automation kits. Machine torches are NOT included in automation kits and must be ordered separately (see page 118).



Spectrum 875 shown.

Includes Ultra-Quick Connect™ XT60 hand-held torch with ergonomic design and flexible cable or **XT60M long body machine torch.**

Light industrial ● 375/625 models
Industrial ● 875 models

DC 3 1 Only 875 Auto-Line has 3-phase capabilities.

Processes

- Air plasma cutting
- Air plasma gouging (625/875 models)

375 X-TREME package comes complete with

- XT30 hand-held torch with 12 ft. (3.7 m) cable
- Heavy-duty work clamp with 12 ft. (3.7 m) flexible cable
- 10 ft. (3 m) power cord with MVP 5-15P (120 V, 15 A) and 6-50P (240 V, 50 A) plugs
- X-CASE for protection and storage
- Shoulder strap
- Consumables box with two electrodes, two tips, deflector and air fitting

625 X-TREME packages come complete with

- XT40 hand-held torch with 12 ft. (3.7 m) or 20 ft. (6.1 m) cable
- Heavy-duty work clamp and flexible cable with quick connect
- 12 ft. (3.7 m) power cord with 240 V, L6-30P twist lock plug
- MVP adapters with 5-15P (120 V, 15 A) and 6-50P (240 V, 50 A) plugs
- X-CASE for protection and storage
- Shoulder strap
- Consumables box with two electrodes, two 40 A tips, one 30 A tip, one 30 A drag shield, deflector and air fitting

875 and 875 Auto-Line packages come complete with

- XT60 hand-held torch with 20 ft. (6 m) or 50 ft. (15.2 m) cable **OR** XT60M long body machine torch with 25 ft. (7.6 m) or 50 ft. (15.2 m) cable
- Heavy-duty work clamp and flexible cable with quick connect
- 10 ft. (3 m) power cord
- Extra consumables
- Machine torch packages include corresponding automation kit

Most popular accessories

- Automation Kits for Spectrum 875 models (pg 118)
- Cables and Cable Covers (pg 118)
- Cutting Guides (pg 118)
- Filters (pg 118)
- Plugs and Cords (pg 118)
- X-CASE (pg 118)
- Torches (pg 118)
- Torch Consumables (pg 118)

Visit MillerWelds.com or your distributor for other Miller® options and accessories.

Model	Input Power	Rated Output at 104°F (40°C)	Amps Input at Rated Output	KVA	KW	Compressor Requirement	Dimensions	Net Weight with Torch
Spectrum 375 X-TREME 120–240 V, 50/60 Hz	Single-phase	120 V (15 A): 20 A at 88 VDC, 60% duty cycle	18.3	2.1	2.1	5.0 cfm (142 L/min.) at 90 psi (621 kPa)	H: 9 in. (229 mm) W: 5.5 in. (140 mm) D: 13.25 in. (337 mm)	12 ft. torch: 19 lb. (8.6 kg)
		120 V (20 A): 27 A at 92 VDC, 35% duty cycle	26.1	3.1	3.1			
		240 V: 30 A at 92 VDC, 40% duty cycle	14.7	3.5	3.4			
Spectrum 625 X-TREME 120–240 V, 60 Hz	Single-phase	120 V (15 A): 20 A at 88 VDC, 60% duty cycle	17.7	2.1	2.1	6.0 cfm (170 L/min.) at 90 psi (621 kPa)	H: 9 in. (229 mm) W: 5.5 in. (140 mm) D: 13.25 in.(337 mm)	12 ft. torch: 21 lb. (9.5 kg) 20 ft. torch: 23 lb. (10.5 kg)
		120 V (20 A): 27 A at 91 VDC, 35% duty cycle	25.0	3.0	3.0			
		240 V: 40 A at 140 VDC, 60% duty cycle	27.6	6.6	6.5			
Spectrum 875 208/230 V, 50/60 Hz	Single-phase	208 V: 60 A at 140 VDC, 40% duty cycle 230 V: 60 A at 140 VDC, 50% duty cycle	208 V: 47 230 V: 42	9.9	9.8	6.75 cfm (191 L/min.) at 90 psi (621 kPa)	H: 13.5 in. (343 mm) W: 8.75 in. (222 mm) D: 18.5 in. (470 mm)	20 ft. torch: 49 lb. (22.2 kg) 25 ft. torch: 51 lb. (23.1 kg) 50 ft. torch: 58 lb. (26.3 kg)
Spectrum 875 Auto-Line 208–575 V, 50/60 Hz	Three-phase	208 V: 60 A at 140 VDC, 40% duty cycle 230–380 V: 60 A at 140 VDC, 50% duty cycle 380–575 V: 60 A at 140 VDC, 60% duty cycle 380–575 V: 50 A at 140 VDC, 100% duty cycle	208 V: 27.5 230 V: 25 380 V: 15 460 V: 12.4 575 V: 9.8	9.9	9.4	6.75 cfm (191 L/min.) at 90 psi (621 kPa)	H: 13.5 in. (343 mm) W: 8.75 in. (222 mm) D: 18.5 in. (470 mm)	20 ft. torch: 54 lb. (24.5 kg) 25 ft. torch: 56 lb. (25.4 kg) 50 ft. torch: 63 lb. (28.6 kg)
	Single-phase	208 V: 60 A at 140 VDC, 40% duty cycle 230 V: 60 A at 140 VDC, 40% duty cycle 230 V: 50 A at 140 VDC, 100% duty cycle	208 V: 47.4 230 V: 42.2	9.9	9.7			



Miller offers an extensive line of quality regulators, cutting torches, tips and a variety of accessories for your oxy-fuel cutting and welding requirements.

Regulators



Series 40

Series 30

Heavy-duty and medium-duty single-stage pressure regulators

Our Series 40™ and Series 30™ industrial-grade pressure regulators provide accurate pressure readings for welding, cutting, heating and other applications. Extremely durable construction and simplified design provide consistent gas flow and longer trouble-free operation. Covered by a three-year warranty. See page 94 for optional Hard Hat™ regulator guards designed to help prevent broken gauges.

Also available
Series 30
single-stage
regulator
twin packs



Stock Number	Gas	Regulator	Max. Delivery Pressure or Flow	Inlet Connection
HTP2	Oxygen	30-100-540	100 psig (7 bar)	CGA 540
	LP Acetylene	30-15-510	15 psig (1 bar)	CGA 510
HTP5	Oxygen	30-100-540	100 psig (7 bar)	CGA 540
	Acetylene	30-15-300	15 psig (1 bar)	CGA 300

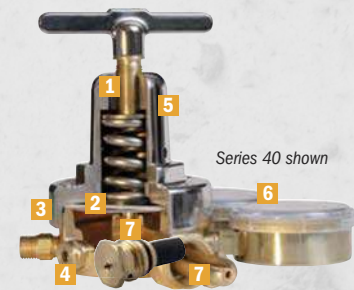

Series 40 shown

Sure Seat filtered high-pressure seat assembly

Features

- 1 Resin bonnet insert** (Series 40/46 only)
Allows smooth, easy adjustment even at high-pressure levels.
- 2 Stainless steel diaphragm**
Resists corrosion, leaking and freeze-up if used with liquid (cryogenic) gases for extended service life.
Note: Series 30 has neoprene composite diaphragm.
- 3 Color-coded labels**
Supplies performance capabilities, easy gas service identification and technical information.
- 4 External relief valve**
Protects regulator from damage due to inadvertent high-pressure surge. Relief valve will release excessive pressure and automatically reset.
- 5 Nickel-plated bonnet**
Along with brass body, protects regulator against corrosion.
- 6 Gauges and lenses**
2.5-inch corrosion-resistant polished brass gauges with shatter-resistant polycarbonate lenses.
Note: Series 30 has 2-inch painted steel gauges.
- 7 Sure Seat™ dual-filtered seat assembly**
Protects high-pressure seat from debris for reliable operation and long service life.



Heavy-duty single-stage station regulators

Our Series 46™ brass line regulators are rugged, accurate and corrosion-resistant. Station regulators are used to connect pipeline gas delivery systems to the welding stations. Because the pipeline pressure is regulated upstream, station regulators only require a single delivery pressure gauge. Covered by a three-year warranty.

**In the chart below, oxygen "C" size inlet connection CGA 024 (7/8"-14 RH) fits station valve Rego. No. 7160. Fuel gases "C" size inlet connection CGA 025 (7/8"-14 LH) fits station valve Rego. No. 7161. Note: Body inlet is 1/4-inch (6 mm) NPT.*



Two-stage regulators

Series 30 two-stage regulators drop cylinder pressure to working pressure in two stages for consistent and accurate outlet pressure and flow regardless of inlet pressure. Recommended where outlet pressure and flow must be maintained without variation. Covered by a three-year warranty.

Model	Stock Number	Gas	Max. Delivery Pressure	Max. Inlet Pressure	Outlet Connection	Inlet Connection
Heavy-Duty Series 40 Single-Stage Pressure Regulators	40-175-540 Single-stage	Oxygen	175 psig (12 bar)	3,000 psig (207 bar)	9/16"-18 RH	CGA 540
	40-275-540 Single-stage	Oxygen	275 psig (19 bar)	3,000 psig (207 bar)	9/16"-18 RH	CGA 540
	40-15-510 Single-stage	Acetylene	15 psig (1 bar)	400 psig (28 bar)	9/16"-18 LH	CGA 510
	40-15-300 Single-stage	Acetylene	15 psig (1 bar)	400 psig (28 bar)	9/16"-18 LH	CGA 300
	40-50-510 Single-stage	LP gas	50 psig (3 bar)	400 psig (28 bar)	9/16"-18 LH	CGA 510
	40-275-580 Single-stage	Inert gas	275 psig (19 bar)	3,000 psig (207 bar)	5/8"-18 RH internal	CGA 580
Medium-Duty Series 30 Single-Stage Pressure Regulators	30-100-540 Single-stage	Oxygen	100 psig (7 bar)	3,000 psig (207 bar)	9/16"-18 RH	CGA 540
	30-20-540 Single-stage	Oxygen	20 psig (1.4 bar)	3,000 psig (207 bar)	9/16"-18 RH	CGA 540
	30-15-510 Single-stage	Acetylene	15 psig (1 bar)	400 psig (28 bar)	9/16"-18 LH	CGA 510
	30-15-300 Single-stage	Acetylene	15 psig (1 bar)	400 psig (28 bar)	9/16"-18 LH	CGA 300
	30-15-520 Single-stage	Acetylene	15 psig (1 bar)	400 psig (28 bar)	9/16"-18 LH	CGA 520
	30-15-200 Single-stage	Acetylene	15 psig (1 bar)	400 psig (28 bar)	9/16"-18 LH	CGA 200
	30-50-510 Single-stage	LP gas	50 psig (3 bar)	400 psig (28 bar)	9/16"-18 LH	CGA 510
	30-150-580 Single-stage	Inert gas	150 psig (10 bar)	3,000 psig (207 bar)	5/8"-18 RH internal	CGA 580
	30-150-320 Single-stage	CO ₂	150 psig (10 bar)	3,000 psig (207 bar)	5/8"-18 RH internal	CGA 320
	30-100-350 Single-stage	Hydrogen/methane	100 psig (7 bar)	3,000 psig (207 bar)	9/16"-18 LH	CGA 350
Heavy-Duty Series 46 Station Regulators	46-175 Single-stage	Oxygen	175 psig (12 bar)	200 psig (14 bar)	9/16"-18 RH "B"	CGA 024*
	46-15 Single-stage	Acetylene	15 psig (1 bar)	200 psig (14 bar)	9/16"-18 LH "B"	CGA 025*
	46-50 Single-stage	LP gas	50 psig (3 bar)	200 psig (14 bar)	9/16"-18 LH "B"	CGA 025*
Series 30 Two-Stage Regulators	35-125-540 Two-stage	Oxygen	125 psig (9 bar)	3,000 psig (207 bar)	9/16"-18 RH "B"	CGA 540
	35-15-510 Two-stage	Acetylene	15 psig (1 bar)	400 psig (28 bar)	9/16"-18 LH "B"	CGA 510
	35-50-580 Two-stage	Inert gas	50 psig (3 bar)	3,000 psig (207 bar)	5/8"-18 RH internal	CGA 580

Regulators

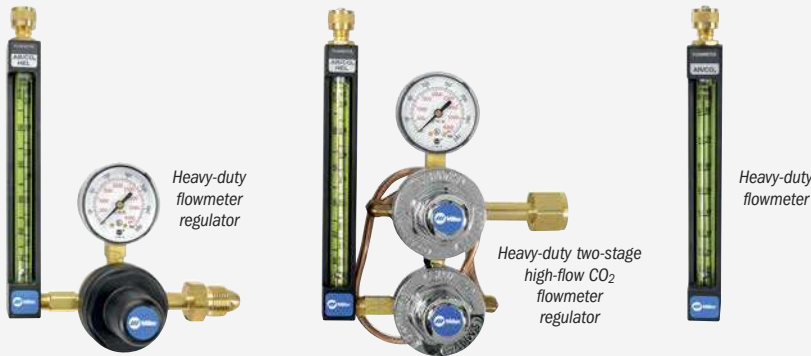

Heavy-duty flowmeter regulator

Heavy-duty two-stage high-flow CO₂ flowmeter regulator

Heavy-duty flowmeter

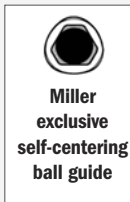

Heavy-duty flowmeter regulators and flowmeters

Our heavy-duty flowmeter regulators and flowmeters feature an exclusive self-centering ball guide which provides accurate readings even if tipped. This ensures optimum weld quality and gas savings. Others use a non-self-centering flow tube ball that tends to float off center causing actual gas flow to be up to two times greater than indicated. Covered by a three-year warranty.



Economy flowmeter regulator

Dual flowmeter regulator

Economy flowmeter

Economy flowmeter regulators and flowmeters

Our economy flowmeter regulators and flowmeters combine exceptional value and a compact design with precise shielding gas regulation for MIG and TIG welding applications and more. Covered by a three-year warranty.



Single-stage flow gauge regulators

Series 30™ single-stage flow gauge regulators are compact and feature a forged brass body and a self-resetting pressure relief valve. They include a Sure Seat™ protective inlet filter and a durable neoprene-composite diaphragm. Covered by a three-year warranty.

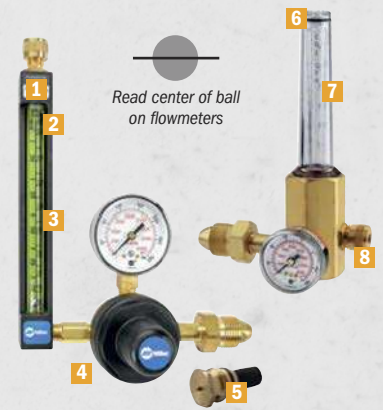

Read center of ball on flowmeters

Heavy-duty model features

- 1 Rugged aluminum protective housing**
Protects flow tubes from damage while offering unobstructed view of flow reading.
- 2 Extra-long flow tube**
Expanded scales are easy to read and accurate within five percent of full reading. Can be attached to regulators or pipeline installations.
- 3 Shatter-resistant multi-scale flow tube**
Made of shatter-resistant polycarbonate resin and features easy-to-read scales for CO₂, argon, argon/CO₂ mix and helium.
- 4 Auto-reset pressure-relief valve**
Protects regulator from damage due to high-pressure surge. Relief valve will release excessive pressure and automatically reset.
- 5 Sure Seat™ dual-filtered seat assembly**
Protects high-pressure seat from debris for reliable operation and long service life.

Economy model features

- 6 Built-in rupture disc**
Reduces possibility of flow tube damage due to high-pressure surge. Must be replaced if ruptured – not auto-resetting.
- 7 Shatter-resistant triple-scale flow tube**
Made of shatter-resistant polycarbonate resin and can be rotated to position desired scale for easy reading. Scaled for CO₂, argon and argon/CO₂ mix, and helium.
- 8 Precision flow-adjustment valve**
Allows easy adjustment to desired setting.

Model	Stock Number	Gas	Flow Range	Max. Inlet Pressure	Outlet Connection	Inlet Connection
Heavy-Duty Flowmeter Regulators	22-80-580 Single-stage	Argon/CO ₂	10-80 scfh (5-38 lpm)	3,000 psig (207 bar)	5/8"-18 RH internal	CGA 580
	22-80-320 Single-stage	CO ₂	10-80 scfh (5-38 lpm)	3,000 psig (207 bar)	5/8"-18 RH internal	CGA 320
	22-30-580 Single-stage	Argon/CO ₂	10-55 scfh (5-26 lpm)	3,000 psig (207 bar)	5/8"-18 RH internal	CGA 580
	22-30-580-6 Single-stage w/gas hose	Helium	10-160 scfh (5-76 lpm)	3,000 psig (207 bar)	5/8"-18 RH internal	CGA 580
	35-30-320 Two-stage high-flow CO ₂	CO ₂	10-55 scfh (5-26 lpm)	3,000 psig (207 bar)	5/8"-18 RH internal	CGA 320
Heavy-Duty Flowmeters	16530 Argon, CO ₂	Argon, CO ₂	10-80 scfh (5-38 lpm)	80 psig (6 bar) recommended	5/8"-18 RH internal	1/4" NPT female
	16531 Argon, CO ₂ , helium	Argon, CO ₂ , helium	Depends on gas	30 psig (2 bar) recommended	5/8"-18 RH internal	1/4" NPT female
Economy Flowmeter Regulators	H2051B-580 Single-stage	Argon	0-60 scfh (0-28 lpm)	3,000 psig (207 bar)	5/8"-18 RH internal	CGA 580
	H2051B-580H Single-stage w/gas hose	CO ₂	0-50 scfh (0-24 lpm)	3,000 psig (207 bar)	5/8"-18 RH internal	CGA 580
	23-50-580 Single-stage dual flowmeter regulator	Helium	0-160 scfh (0-78 lpm)	3,000 psig (207 bar)	5/8"-18 RH internal	CGA 580
Economy Flowmeters	H2230A Multi-scale	Argon, helium, CO ₂	Depends on gas	50 psig (3 bar) recommended	5/8"-18 RH internal	1/4" NPT male
	H2231A Multi-scale	Argon, helium, CO ₂	Depends on gas	50 psig (3 bar) recommended	5/8"-18 RH internal	5/8"-18 RH external
Heavy-Duty Series 30 Flow Gauge Regulators	31-50-580 Single-stage	Argon	0-50 scfh (0-24 lpm)	3,000 psig (207 bar)	5/8"-18 RH internal	CGA 580
	31-50-580-6 Single-stage w/gas hose	Argon	0-50 scfh (0-24 lpm)	3,000 psig (207 bar)	5/8"-18 RH internal	CGA 580
	31-50-320 Single-stage	CO ₂	0-50 scfh (0-24 lpm)	3,000 psig (207 bar)	5/8"-18 RH internal	CGA 320

Regulators



HVAC/refrigeration purge/leak test regulator

Our single-stage nitrogen regulator is specially designed to meet the specifications of HVAC refrigerant purging applications. This regulator is used with nitrogen to test HVAC systems to locate leaks and to purge an area for installation and repair. It is economical, accurate and its compact size is useful where space is limited. Covered by a one-year warranty.

- 2-inch (51 mm) gauges with shatter-resistant lenses and solid brass body for durability
- Large durable nylon knob for easy pressure adjustment

Stock Number	Gas	Max. Delivery Pressure	Max. Inlet Pressure	Outlet Connection	Inlet Connection
30-450-580	Nitrogen	450 psig (31 bar)	3,000 psig (207 bar)	7/16"-20 external flair fitting	CGA 580



Heavy-duty high-pressure regulator

820 Series regulators are for use on cylinders with a wide variety of non-corrosive inert gases. Typical applications include high-pressure testing, purging/charging, calibration kits, airline charging carts, chemical plants, manufacturing processes, research/development and laboratories. Covered by a two-year warranty.

- Piston-sensor design gives structural reliability in high-pressure use
- Low-torque-control adjusting screw for easy pressure adjustments in closed/dead end systems
- Due to specific configurations, we cannot accept returns of 820 Series regulators

Model Series	Max. Delivery Pressure	Max. Inlet Pressure	Option 1	Model Configuration	Option 3
823	500 psig	6,000 psig	Outlet pressure	825 - 66 26	Inlet connection (additional inlet connections available)/Max. inlet pressure
824	1,000 psig		823 0-500 psig	Option 2 Outlet connection	00 1/4" FNPT
825	2,000 psig		824 0-1,000 psig		08 CGA 540 (oxygen) 3,000 psig
826	4,000 psig		825 0-2,000 psig		09 CGA 580 (inert) 3,000 psig
827	6,000 psig		826 0-4,000 psig		26 CGA 347 stainless steel 5,500 psig
			827 0-6,000 psig		27 CGA 677 stainless steel 7,500 psig
			28 CGA 680 stainless steel 5,500 psig		



Rear-entry liquid cylinder regulator

250 Series regulators are ideal for non-corrosive high-purity applications and have a rear-entry connection that provides clearance of the liquid cylinder ring for easier gauge reading. Covered by a two-year warranty.

- Easy-to-read single-scale 2.5-inch (64 mm) gauge with shatter-resistant lens
- Nickel-plated brass body for corrosion resistance
- Large 1.875-inch stainless steel diaphragm for precise control of pressure
- Large durable nylon knob for easy pressure adjustment
- Due to specific configurations, we cannot accept returns of 250 Series regulators

Note: Use Series 40™ heavy-duty regulators constructed with a stainless steel diaphragm for high-volume or liquid (cryogenic) cylinder applications.

Model Series	Max. Delivery Pressure	Max. Inlet Pressure	Option 1	Model Configuration	Option 3
252	100 psig	3,500 psig	Outlet pressure	252 - 20 08	Inlet connection
254	200 psig		252 0-100 psig	Option 2 Outlet connection	00 1/4" FNPT
255	350 psig		254 0-200 psig		20 Chrome needle valve with 1/4" NPT
256	500 psig		255 0-350 psig		82 9/16"-18 RH "B"
			256 0-500 psig		

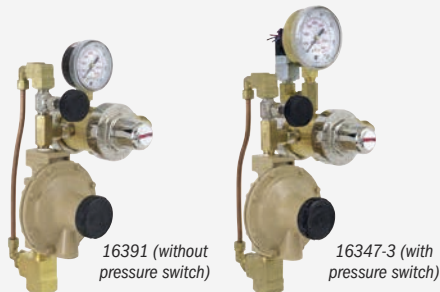

Three-stage nitrogen low-pressure regulator

These preset regulators are specially designed to deliver a highly accurate and consistent 0.50 psig supply of nitrogen to the head space of oil-filled power transformers. Available with or without electronic pressure switch. Covered by a one-year warranty.

- Built-in self-relieving valve set at 8 psig protects the system from over-pressurization due to temperature variation
- Rapid-fill bypass pressure valve allows rapid filling of the transformer with 6 psig of pressure

Note: Operation temperature: -40° to +180° Fahrenheit. Operation voltage (model 16347-3): 5 amps at 12/24 volts DC or 125 volts AC. 3 amps at 250 volts. Pressure switch setting: Adjustable from 70-300 psig (ships preset at 250 psig), 3/32-inch Allen head screw switch. Switch wiring: Normally open or normally closed (DPDT), three 18-inch flying leads.

Stock Number	Preset Outlet Pressure			Bypass Rapid Fill/Purge	Max. Inlet Pressure	Outlet Connection	Inlet Connection
	1st Stage	2nd Stage	3rd Stage (delivery pressure)				
16391 without pressure switch	150 psig (10 bar)	8 psig (0.6 bar)	0.4-0.6 psig (0.03-0.04 bar) into outlet	6 psig (0.4 bar)	3,000 psig (207 bar)	1/2" FNPT	CGA 580
16347-3 with pressure switch	into 2nd stage	into 3rd stage					

Most popular accessories



- **Hard Hat™ Regulator Guards**
HB190 For Series 40
H195 For Series 30

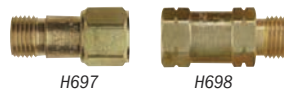

- **Reverse-Flow Check Valve Set (oxy and fuel)**
H697 Torch mount
H698 Regulator mount



- **Flashback Arrestor Set (oxy and fuel)**
H743 Torch mount
H753 Regulator mount



- **GASAVER™**
WDW100 Propylene/oxygen
WDW101 Acetylene/oxygen
WDW103 Propane or natural gas (less than 4 psi)
WDW104 Propane or natural gas/oxygen (4 psi and above)
- For repetitious brazing and soldering
- Hang torch to shut off
- Pilot light for relighting
- Eliminates flame readjustment



- **Fixed-Flow Adapters and Surge Protectors**
H1400 Series fixed-flow adapters are for welding operations requiring fixed-flow gases. 15001 Series surge protectors are for MIG welding applications to eliminate sudden surges of shielding gas in the wire feeder. Visit MillerWelds.com for more information.

Visit MillerWelds.com or your distributor for other Miller® options and accessories.

Torches



Cutting torches (acetylene, natural gas, LP or propylene-based fuels)

Gas Axe® extra-heavy-duty cutting torches are ideal for scrap and salvage.

- Covered by a one-year warranty
- Reversible (top or bottom) mount cutting lever
- Available in four lengths and three different head angles
- Uses our exclusive long-lasting Graf-Tite® soft-seat cutting tips with in-tip gas mixing for added resistance to flashbacks
- Cuts up to 20 inches (508 mm) with LP and up to 12 inches (305 mm) with acetylene or propylene

Heavy-duty cutting torches feature solid construction and ease of operation for industries such as construction, fabrication, shipyards and salvage.

- Covered by a five-year warranty
- Nickel-plated finish for added corrosion resistance and to reflect residual heat
- Reversible (top or bottom) mount cutting lever
- Available in three lengths and three different head angles
- Uses our exclusive long-lasting Graf-Tite® soft-seat cutting tips with in-tip gas mixing for added resistance to flashbacks
- Cuts up to 12 inches (305 mm)



Combination torches (acetylene, natural gas, LP or propylene-based fuels)

Constructed to last a lifetime for safe performance under rugged conditions.

- Covered by a five-year warranty
- Heavy- and medium-duty torches feature a Flo-Trol valve to help prevent the accidental reverse flow of mixed gases and a spring-loaded back-pressure check valve designed to stop the most common cause of cutting valve seat burnout
- Ease-on cutting oxygen valve to reduce slag blowback when piercing
- Thick-wall brass head forgings resist warping and distortion
- Heavy- and medium-duty torches are available with 75- or 90-degree head angles
- Uses our exclusive long-lasting Graf-Tite® soft-seat cutting tips with in-tip gas mixing for added resistance to flashbacks
- Heavy-duty torches cut up to 8 inches (203 mm), medium-duty up to 6 inches (152 mm) and standard-duty up to 3 inches (76 mm)



Machine torches (acetylene, natural gas, LP or propylene-based fuels)

Superior performance with solid construction.

- Covered by a five-year warranty
- Torch barrels are adjustable to four positions at 90-degree increments and barrel diameters are 1-3/8 inches (9.5 mm) to fit most machines
- Rack pitch is 32-8 teeth per inch
- Uses our exclusive long-lasting Graf-Tite® soft-seat cutting tips with in-tip gas mixing for added resistance to flashbacks
- SC781A high-capacity three-hose torch cuts up to 12 inches (305 mm) with acetylene or propylene and 20 inches (508 mm) with LP or natural gas
- SC770 and SC772A two-hose torches cut up to 12 inches (305 mm) with acetylene, propylene, LP or natural gas

Torches

Stock Number	Head Angle in Degrees	Length Inches (mm)
--------------	-----------------------	--------------------

Gas Axe Extra Heavy-Duty Cutting Torches

SC925	75	21 (533)
SC929	90	21 (533)
SC935	75	36 (914)
SC939	90	36 (914)
SC930	180	36 (914)
SC945	75	48 (1,219)
SC949	90	48 (1,219)
SC940	180	48 (1,219)
SC965	75	72 (1,829)
SC969	90	72 (1,829)
SC960	180	72 (1,829)

Heavy-Duty Cutting Torches

SC175	75	17 (432)
SC179	90	17 (432)
SC225	75	21 (533)
SC225S	75	21 (533)
SC229	90	21 (533)
SC229S	90	21 (533)
SC220	180	21 (533)
SC365	75	36 (914)
SC369	90	36 (914)
SC360	180	36 (914)

Heavy-Duty Combination Torches

SC205	75	12.5 (318)
SC209	90	12.5 (318)
WH200A	Handle	7.5 (191)

Medium-Duty Combination Torches

MC505	75	11.25 (286)
MC509	90	11.25 (286)
WH100	Handle	7 (178)

Standard-Duty Combination Torches

AC309	90	8.5 (216)
AW1A	Handle	5.75 (146)

Machine Torches

SC781A	—	15.5 (394)
SC772A	—	13.75 (349)
SC770	—	8 (203)

Most popular accessories



- Circle Cutter Guide 16229



- Flashback Arrestor Set (oxy and fuel)
H743 Torch mount
H753 Regulator mount



- Safety Glasses
(see page 108 for more styles)
235661 Blue frame/shade 3
235657 Blue frame/shade 5
- Safety Gloves (pg 110)

Visit MillerWelds.com or your distributor for other Miller® options and accessories.

Heavy-Duty Outfits



HBA-40510

Combination torch outfits (acetylene or LP)

Oxy-fuel outfits include just about everything needed for your cutting, welding, brazing or heating project.

- Heavy-duty Series 40™ **OR** medium-duty Series 30™ regulators with a three-year warranty
- Heavy-duty torches with a five-year warranty
- Torch-mount flashback arrestors for added safety (acetylene outfits only)
- Exclusive long-lasting Graf-Tite® soft-seat cutting tips with in-tip gas mixing for added resistance to flashbacks
- Both HBA-40510 and HBA-40300 outfits cut up to 1-1/4 inch (32 mm) with tip included, other outfits cut up to 5/8 inch (16 mm)
- All outfits cut up to 8 inches (203 mm) with optional tips

Combination torch and tip kits (acetylene or LP)

Combination kits are available with cutting, welding and heating tips **OR** with multiple cutting tips.

- Heavy-duty torches with a five-year warranty
- Torch-mount flashback arrestors for added safety
- Exclusive long-lasting Graf-Tite® soft-seat cutting tips with in-tip gas mixing for added resistance to flashbacks
- Cuts up to 5/8 inch (16 mm) with tip included
- Cuts up to 8 inches (203 mm) with optional tips

Cutting torch outfits (acetylene)

Hand cutting torch outfits are built for the toughest jobs.

- Corrosion-resistant regulators feature shatter-resistant polycarbonate gauge lenses
- 21-inch nickel-plated torch with a five-year warranty has reversible (top or bottom) mount cutting lever and an ease-on oxygen feature that reduces slag blowback when piercing
- Exclusive long-lasting Graf-Tite® soft-seat cutting tips with in-tip gas mixing for added resistance to flashbacks
- HBS outfits include heavy-duty Series 40™ regulators with a three-year warranty and Hard Hat™ gauge/regulator guards
- HBAS outfits include medium-duty Series 30™ regulators with a three-year warranty, torch-mount flashback arrestors for added safety, plus hose, lighter, safety glasses and tip cleaner
- HBS outfits cut up to 1-1/4 inch (32 mm) with tip included, HBAS outfits cut up to 5/8 inch (16 mm)
- All outfits cut up to 12 inches (305 mm) with optional tips



16206

16280



HBS-H510S

HBAS-30510

*Acetylene regulator has CGA 300 inlet fitting.

Heavy-duty torch tips

Stock Number	Max. Metal Thickness Inches (mm)	Cutting Jet Drill Size
Acetylene Cutting		
SC12-00	3/16 (5)	68
SC12-0	3/8 (10)	62
SC12-1	5/8 (16)	56
SC12-2	1-1/4 (32)	54
SC12-3	2 (51)	51
SC12-4	4 (102)	45
SC12-5	8 (203)	41
SC12-6	12 (305)	32
Propane/Natural Gas Cutting		
SC50-00	3/16 (5)	68
SC50-0	3/8 (10)	62
SC50-1	5/8 (16)	56
SC50-2	1-1/4 (32)	54
SC50-3	2 (51)	51
SC50-4	4 (102)	45
SC50-5	8 (203)	41
SC50-6	12 (305)	32
SC50-7	14 (354)	28
SC50-8	18 (457)	17
SC50-9	20 (508)	3
Propylene Cutting		
SC60-0	3/8 (10)	62
SC60-1	5/8 (16)	56
SC60-2	1-1/4 (32)	54
SC60-3	2 (51)	51
SC60-4	4 (102)	45
SC60-5	8 (203)	41
SC60-6	12 (305)	32
Acetylene Gouging		
SC13-3	3/8 (10) wide, 1/4 (6) deep	
Propane/Natural Gas Gouging		
SC23-3	3/8 (10) wide, 1/4 (6) deep	
Propylene Gouging		
SC23-3M	3/8 (10) wide, 1/4 (6) deep	
Acetylene Welding		
SW201	1/32 in. (0.7 mm)	
SW203	5/64 in. (1.9 mm)	
SW205	1/8 in. (3 mm)	
SW207	3/16 in. (5 mm)	
SW209	3/8 in. (10 mm)	
SW210	1/2 in. (13 mm)	
Acetylene Heating		
ST602	40,000 Btu	
ST603	72,000 Btu	
ST605	125,000 Btu	
ST610	195,000 Btu	

Visit MillerWelds.com or your distributor for additional tips, options and accessories.

Outfit	Stock Number	Fuel	Cut Tip	Weld Tip	Heat Tip	Description	Typical Applications
Combination Torch Complete Outfits	HBA-40510	Acetylene	SC12-1	SW205	ST602	Heavy-duty combination torch, heavy-duty regulators, 25 ft. (7.6 m) hose, lighter, safety glasses, tip cleaner and flashback arrestors	Heavy fabrication, construction, pipeline, maintenance/repair, rail and truck repair
	HBA-40300*		SC12-2				
	HBA-30510	Acetylene	SC12-1	SW205	ST602		
	HBA-30300*						
	HBA-30510LP	Propane	SC40-1	—	ST615	Heavy-duty combination torch, medium-duty regulators, 20 ft. (6.1 m) "T"-grade hose, lighter, safety glasses, tip cleaner and check valves	
Combination Torch and Tip Kits	16206	Acetylene	SC12-1	SW203	ST602	Heavy-duty combination torch and flashback arrestors	Heavy fabrication, construction, pipeline, maintenance/repair, rail and truck repair
	16280	Acetylene	SC12-0, SC12-1	—	—		
Cutting Torch Outfits	HBS-H510S	Acetylene	SC12-2	—	—	Heavy-duty SC229 hand cutting torch and heavy-duty regulators with Hard Hat™ gauge guards	Heavy fabrication, construction, shipyard, rail car, rail and truck repair
	HBS-H300S*						
	HBAS-30510	Acetylene	SC12-1	—	—	Heavy-duty SC229 hand cutting torch, medium-duty regulators, 20 ft. (6.1 m) hose, lighter, safety glasses, tip cleaner and flashback arrestors	
	HBAS-30300*						

Medium-Duty Outfits



Combination torch outfits (acetylene or LP)

Oxy-fuel outfits include just about everything needed for your cutting, welding, brazing or heating project.

- Medium-duty Series 30™ regulators with a three-year warranty
- Medium-duty torches with a five-year warranty
- Torch-mount flashback arrestors for added safety (acetylene outfits only)
- Exclusive long-lasting Graf-Tite® soft-seat cutting tips with in-tip gas mixing provides for resistance to flashbacks
- Cuts up to 5/8 inch (16 mm) with tip included
- Cuts up to 6 inches (153 mm) with optional tips



Combination torch and tip kits (acetylene or LP)

Combination kits are available with cutting, welding and heating tips **OR** with multiple cutting tips.

- Medium-duty torches with a five-year warranty
- Torch-mount flashback arrestors for added safety
- Exclusive long-lasting Graf-Tite® soft-seat cutting tips with in-tip gas mixing for added resistance to flashbacks
- Cuts up to 5/8 inch (16 mm) with tip included
- Cuts up to 6 inches (153 mm) with optional tips



Toughcut™ combination torch outfits (acetylene or LP)

Economy outfits include many features found on more expensive outfits.

- Medium-duty Series 30™ regulators with a three-year warranty
- Medium-duty torches with a three-year warranty
- Check valves for added safety and torch life
- Exclusive long-lasting Graf-Tite® soft-seat cutting tips with in-tip gas mixing for added resistance to flashbacks
- Cuts up to 5/8 inch (16 mm) with tip included
- Cuts up to 6 inches (153 mm) with optional tips



Tag-A-Long™ and Versa-Torch™ portable outfits (acetylene)

Complete, portable outfits housed in carriers designed for mobility and ease of storage, plus long-lasting Graf-Tite® soft-seat cutting tips and check valves for added safety and torch life.

- Tag-A-Long includes medium-duty Series 30™ regulators and medium-duty torch with three-year warranties
- Versa-Torch includes Series 30™ regulators with a three-year warranty and standard-duty torch with a five-year warranty

*Acetylene regulator has CGA 300 inlet fitting.

Medium-duty torch tips

Stock Number	Max. Metal Thickness Inches (mm)	Cutting Jet Drill Size
Acetylene Cutting		
MC12-00	3/16 (5)	68
MC12-0	3/8 (10)	62
MC12-1	5/8 (16)	55
MC12-2	1 (25)	54
MC12-3	2 (51)	51
MC12-4	4 (102)	45
MC12-5	6 (152)	41
Propane/Natural Gas Cutting		
MC40-00	3/16 (5)	68
MC40-0	3/8 (10)	62
MC40-1	5/8 (16)	55
MC40-2	1-1/4 (32)	54
MC40-3	2 (51)	51
MC40-4	4 (102)	51
Propylene Cutting		
MC60-1	5/8 (16)	55
MC60-2	1-1/4 (32)	54
MC60-3	2 (51)	51
MC60-4	4 (102)	45

Acetylene Gouging

MC13-3	3/8 (10) wide, 1/4 (6) deep
--------	-----------------------------

Note: Tips above fit medium- and standard-duty torches.

Acetylene Welding

MW201	1/32 in. (0.7 mm)
MW203	5/64 in. (1.9 mm)
MW205	1/8 in. (3 mm)
MW207	3/16 in. (5 mm)
MW209	3/8 in. (10 mm)

Acetylene Heating

MT603	40,000 Btu
MT605	73,000 Btu
MT610	129,000 Btu

Visit MillerWelds.com or your distributor for additional tips, options and accessories.

Outfit	Stock Number	Fuel	Cut Tip	Weld Tip	Heat Tip	Description	Typical Applications
Combination Torch Complete Outfits	MBA-30510	Acetylene	MC12-0	MW205	MT603	Medium-duty combination torch, medium-duty regulators, 20 ft. (6.1 m) hose, lighter, safety glasses, tip cleaner and flashback arrestors	Fabrication, farm and ranch, pipe, truck and auto, refrigeration, maintenance/repair
	MBA-30300*		MC12-1				
	MBA-30510LP	Propane	MC40-1	–	MT805	Medium-duty combination torch, medium-duty regulators, 20 ft. (6.1 m) "T"-grade hose, lighter, safety glasses, tip cleaner and check valves	
Combination Torch and Tip Kits	16205	Acetylene	MC12-1	MW203	MT603	Medium-duty combination torch and flashback arrestors	Fabrication, farm and ranch, pipe, truck and auto, refrigeration, maintenance/repair
	16281	Acetylene	MC12-0, MC12-1	–	–		
Toughcut Economy Combination Torch Outfits	MB55A-510	Acetylene	MC12-1	MW205	MT603	Medium-duty combination torch, medium-duty regulators, 20 ft. (6.1 m) hose, lighter, safety glasses and check valves	Fabrication, farm and ranch, pipe, hobby, auto, refrigeration, maintenance/repair
	MB55A-300*						
	MB54A-510	Acetylene	MC12-1	MW205	–		
	MB54A-300*						
	MB54A-510LP	Propane	MC40-1	–	–	Medium-duty combination torch, medium-duty regulators, 20 ft. (6.1 m) "T"-grade hose, lighter, safety glasses and check valves	
Combination Torch Portable Outfits	TL-500 (no tanks)	Acetylene	MC12-0	MW203	–	Medium-duty (TL500/TL550) or standard-duty (VT-4T) combination torch, medium-duty regulators, 12.5 ft. (3.8 m) hose, carrier, lighter, safety glasses, check valves and cylinders (cylinders NOT included with TL-500)	Farm and ranch, hobby, DIY, auto, refrigeration, maintenance/repair
	TL-550						
	VT-4T	Acetylene	MC12-00	LT103, LT104, LT106	13716		

Proportional Gas Mixers

Our line of proportional gas mixers can help your operation save money, work more efficiently and produce better-quality welds by providing proper shielding gas mixtures for frequently used welding processes.



Argon/CO₂ gas mixer 299-006-1C shown.

Accurate, on-site shield gas mixing. Various welding processes require different gas mixes for the best results. Our proportional gas mixers are accurate and allow custom mixtures for optimal welds.

No stocking or handling of premixed gases saves time and money and also reduces the number of cylinders that need to be stored.

Reduces setup time. No need to change cylinders, regulators, flow control devices or hoses when switching from one range of mixed gas to another.

Ideal for education and training. Operators can quickly see the effect of various gas mixtures on weld appearance, quality and penetration.

Easy operation. Simply set the dials for the desired mix and flow. Mixers are mechanical, no electricity is required.

Serves from one to five welding stations with a single mixer. Delivers accurate mixtures at flows ranging from 10 to 180 scfh.

Covered by a one-year warranty.

Stock Number	Gases	Adjustment % Range	Flow Range	Outlet Pressure	Required Inlet Pressure	Outlet Connection	Inlet Connection	Conversion Tables
299-006-1C	Argon	0-100%	10-180 scfh	50 psig (3.5 bar)	105-115 psig (7.3-7.9 bar)	5/8"-18 RH internal	5/8"-18 RH internal	Argon/helium Argon/oxygen CO ₂ /oxygen
	CO ₂	100-0%					5/8"-18 RH internal	
299-006-3C	Argon	0-100%	10-180 scfh	50 psig (3.5 bar)	105-115 psig (7.3-7.9 bar)	5/8"-18 RH internal	5/8"-18 RH internal	Argon/CO ₂ Argon/oxygen CO ₂ /oxygen
	Helium	100-0%					5/8"-18 RH internal	
299-011-1C	Argon	50-100%	10-180 scfh	50 psig (3.5 bar)	105-115 psig (7.3-7.9 bar)	5/8"-18 RH internal	5/8"-18 RH internal	Argon/helium Nitrogen/hydrogen Argon/oxygen Argon/CO ₂
	Hydrogen	50-0%					9/16"-18 LH external	
299-014-1C	Argon	80-100%	10-180 scfh	50 psig (3.5 bar)	105-115 psig (7.3-7.9 bar)	5/8"-18 RH internal	5/8"-18 RH internal	Argon/CO ₂ Argon/hydrogen Argon/helium Nitrogen/hydrogen
	Oxygen	20-0%					5/8"-18 RH internal	

Register Your New Welder

Complete registration as soon as possible — it's quick and easy.

Registering your new Miller® equipment may help with any future insurance claims or in the event we need to contact you regarding changes or upgrades. Whether you're a DIY welder or have purchased Miller equipment on behalf of the company for which you work... **all Miller equipment should be registered** so we can provide you with the highest level of service.



Register now at MillerWelds.com/register



Safety products designed to protect welders and enhance their long-term performance

The Miller focus has always been welding – understanding welders, their pain points and the safety products used to protect them within their work environments. As your single-source solution for welding environment control products that fulfill each level of OSHA’s hierarchy of controls, we will help you get maximum productivity out of each welder while keeping them comfortable and improving compliance. Our complete line of Weld Environment, Head and Face, and Hand and Body protection is designed to protect and perform in demanding welding, cutting and grinding applications.

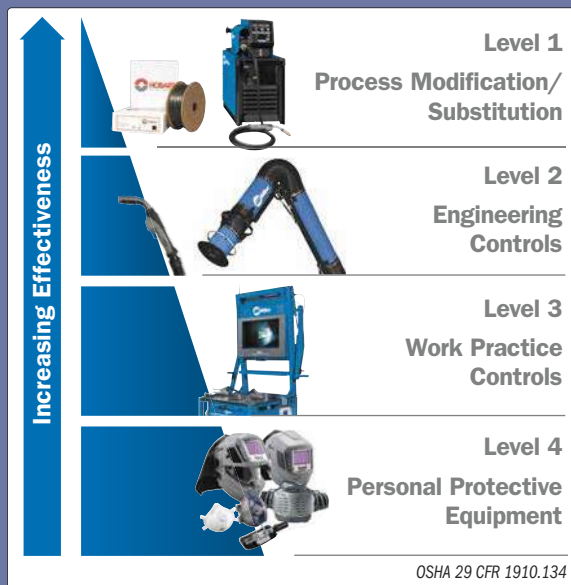

Fume Extractors

Our line of **FILTAIR®** fume extractors are designed specifically for welding – drawing weld fumes away from the user’s breathing zone and keeping your facility clean. We offer many types of fume extraction equipment to best fit your environment. Visit MillerWelds.com/filtair for more information.

FILTAIR	130	MWX	Capture 5	SWX	4000–12000
Weld Fume Extractor Type	Portable, high-vacuum	Mobile, low-vacuum	Mobile, low-vacuum with the industry’s largest capture zone	Stationary, low-vacuum suited for wall or column mounting	Centralized, low-vacuum customizable systems
Ideal For	Contractors, maintenance and repair operations, light fabrication work and light manufacturing	Fabrication shops, manufacturing, and training centers	Manufacturing and fabrication – the best solution for weldments over 18 inches long	Fabrication shops, manufacturing, and training centers where weld areas are near filtration system	Manufacturing, hand-held and automation, fabrication shops, and training facilities
Technology	–	–	ZoneFlow (see pg 102)	Available w/ZoneFlow (see pg 102)	Available w/ZoneFlow (see pg 102)
Welding Arcs	1	1	1	Up to 2 per unit	Up to 16 per unit
Filter Type	Manual cleaning	MWX-D: Disposable MWX-S: Self-cleaning	Self-cleaning (automatic)	SWX-D: Disposable SWX-S: Self-cleaning	Self-cleaning (automatic/programmable)

FILTAIR® 130

See literature AY/3.1



Portable, high-vacuum weld fume extractor designed for use with accessories like nozzles and fume guns to collect weld fume particles at the source.

Designed to capture weld fume. The MERV 15 rating of FilTek XL filters provides superior filtering of up to 95 percent of weld fume particulate.

Unrivaled filtering performance. Designed to capture weld fume particles with a cleanable filter and safely deposit them in an integrated particle bin.

Less noise. Up to 70 percent quieter than some other extractors. Only 68.5 decibels at five feet.

Portable and compact. At only 46 pounds (21 kg) the vertical-shaped machine is easy to move around.

Processes

- Stick (SMAW) ▪ Flux-cored (FCAW)
- MIG (GMAW) ▪ TIG (GTAW)

Comes with

- FilTek® XL filter
- 8 ft. (2.4 m) collection hose
- 20 ft. (6 m) power cord

Most popular consumables

- FilTek® XL Filter 301267

Most popular accessories

- Collection Hose
300896 17 ft. (5.2 m)
300897 34 ft. (10.4 m)

▪ Magnetic Nozzle

- 300895
12 in. (305 mm) width



- Flexible Funnel Magnetic Nozzle 300668

- Bernard® Clean Air™ Fume Extraction MIG Gun (pg 26)

Stock Number (300595)	Accu-Rated™ Airflow	Sound Level	Motor	Input Power	Dimensions	Net Weight
	132 cfm (62 L/sec.)	68.5 dBA at 5 ft. (1.5 m)	1.27 kW	115 V, 1-phase, 60 Hz at 11.25 A	H: 23 in. (584 mm) W: 12 in. (305 mm) D: 12 in. (305 mm)	46 lb. (21 kg)



FILTAIR® MWX Series and Capture 5

See literature AY/3.0 (MWX) and AY/3.5 (Capture 5)

Mobile fume extraction systems easily positioned near the weld area and designed specifically for welding. Disposable or cleanable filter models for multiple applications.



MWX-S (self-cleaning filter) model shown with 10 ft. extraction arm.



Capture 5 shown with 12 ft. ZoneFlow extraction arm.

Features common to all models

Source capture. Designed to draw weld fume away from the welder's breathing zone and keep the facility clean.

Superior filters. The MERV 15 rating of our FilTek XL filters provides superior filtering of up to 95 percent of weld fume particulate. They outlast, out-filter, and outperform all the rest.

Class-leading suction power of 875/900 cfm is Accu-Rated™ at the hood to better capture weld fumes and provide a cleaner environment.

Durable aluminum pre-assembled extraction arm with external adjustments for better airflow and longer life.

Self-cleaning models additional features

Upgrade to self-cleaning models for high arc-on time, extracting from heavy fume processes, or when welding aluminum or galvanized materials.

Unrivaled filtering performance. Weld fume particles are captured with a cleanable filter and safely deposited in an integrated particle bin.

Quick and efficient cleaning cycle operates with a push of a button on the control panel.

Note: Compressed air required to operate cleaning mechanism.

Disposal drawer provides easy and convenient access to empty out collected particles. Handle releases drawer allowing it to slide out.

Capture 5 model additional features

EXCLUSIVE! ZoneFlow™ technology. Extends the capture zone up to five feet versus 12 to 18 inches with conventional source capture arms. See page 102 for more information.

Minimizes downtime with fewer fume extractor adjustments. With increased capture area, arm interactions are dramatically minimized.

Processes

- Stick (SMAW) ▪ Flux-cored (FCAW)
- MIG (GMAW) ▪ TIG (GTAW)

Comes with

- FilTek® XL filter
- Pre-assembled arm

Most popular consumables



Replacement FilTek XL Filters

- 300540 For MWX (self-cleaning)
 - 300539 For MWX (disposable)
 - 301106 For Capture 5 (self-cleaning)
- Filters efficiently capture the smallest weld fume particles and offer superior filter life

Most popular accessories



Hood Light with Arc Sensor

- 300689 For MWX Series
- Illuminates the welding zone and enables the fume extractor to start automatically when welding begins

Model/Stock Number	Filter Media	Accu-Rated™ Airflow	Extraction Arm Diameter	Sound Level	Motor	Input Power	Dimensions	Net Weight
MWX-S (Self-Cleaning) (951510) 7 ft. standard arm (951511) 10 ft. standard arm (951512) 12 ft. standard arm	MWX-D (Disposable Filter) (951507) 7 ft. standard arm (951508) 10 ft. standard arm (951509) 12 ft. standard arm	490 sq. ft. (45.52 sq. m)	8 in. (203 mm)	Approximately 70 dBA at 5 ft. (1.5 m)	1 hp, 3,450 rpm	115 V, 1-phase, 60 Hz at approximately 11.9 A	H: 34.75 in. (883 mm) W: 31.75 in. (806 mm) D: 48 in. (1,219 mm)	MWX-S: 300 lb. (136 kg) MWX-D: 238 lb. (108 kg)
Capture 5 (Self-Cleaning) (951639) 208/230 V, 10 ft. ZoneFlow arm (951640) 208/230 V, 12 ft. ZoneFlow arm (951574) 460 V, 10 ft. ZoneFlow arm (951575) 460 V, 12 ft. ZoneFlow arm		452 sq. ft. (42 sq. m)	10 in. (254 mm)	Approximately 77 dBA at 5 ft. (1.5 m)	3 hp, 3,450 rpm	208/230 V, 1-phase, 60 Hz at 13.5 A 460 V, 3-phase, 60 Hz at 3.7 A	H: 43 in. (1,092 mm) W: 36 in. (915 mm) D: 48 in. (1,219 mm)	620 lb. (282 kg) with 12 ft. arm



FILTAIR® SWX Series

See literature AY/3.2 (SWX)

Stationary fume extraction systems wall- or column-mounted next to the weld area and designed specifically for welding. Disposable or cleanable filter models for multiple applications.



SWX-D (disposable filter) model shown with telescoping arm.



SWX-S (self-cleaning filter) model shown with 12 ft. ZoneFlow extraction arm.

Features common to all models

Source capture. Designed to draw weld fume away from the welder's breathing zone and keep the facility clean.

Superior filters. The MERV 15 rating of our FilTek XL filters provides superior filtering of up to 95 percent of weld fume particulate. They outlast, out-filter, and outperform all the rest.

Class-leading suction power of 875 cfm is Accu-Rated™ at the hood to better capture weld fumes and provide a cleaner environment.

Durable aluminum pre-assembled extraction arms. Choose from three different arm styles:

- **Telescoping arms** fit small booth spaces and telescope from 3 to 4.5 feet
- **Standard arms** cover larger spaces and are available in 7-, 10-, and 12-foot versions
- **ZoneFlow arms (self-cleaning models only)** extend the capture zone up to 5 feet and are available in 10- and 12-foot versions

Self-cleaning models additional features

Upgrade to self-cleaning models for high arc-on time, extracting from heavy fume processes, or when welding aluminum or galvanized materials.

Unrivaled filtering performance. Weld fume particles are captured with a cleanable filter and safely deposited in an integrated particle bin.

Quick and efficient cleaning cycle operates with a push of a button on the control panel.

Note: Compressed air required to operate cleaning mechanism.

Disposal drawer provides easy and convenient access to empty out collected particles. Handle releases drawer allowing it to slide out.

ZoneFlow™ arm additional features

EXCLUSIVE! ZoneFlow technology. Extends the capture zone up to five feet versus 12 to 18 inches with conventional source capture arms. See page 102 for more information.

Minimizes downtime with fewer fume extractor adjustments. With increased capture area, arm interactions are dramatically minimized.

Processes

- Stick (SMAW) ▪ Flux-cored (FCAW)
- MIG (GMAW) ▪ TIG (GTAW)

Comes with

- FilTek® XL filter
- Pre-assembled arm

Most popular consumables



▪ Replacement FilTek XL Filters

- 300540 For self-cleaning models
 - 300539 For disposable filter models
- Filters efficiently capture the smallest weld fume particles and offer superior filter life

Most popular accessories



▪ Hood Light with Arc Sensor

- 300763 For SWX Series
- (telescoping and standard arms only) Illuminates the welding zone and enables the fume extractor to start automatically when welding begins



▪ SWX Dual-Arm Add-On Packages

- 951621 With telescoping arm
 - 951519 With 7 ft. standard arm
 - 951520 With 10 ft. standard arm
 - 951521 With 12 ft. standard arm
 - 951762 With 10 ft. ZoneFlow arm
 - 951822 With 12 ft. ZoneFlow arm
- Includes 8-inch diameter arm, blower, control box, mounting bracket, duct and back draft dampers to turn single-arm weld fume extractor into dual-arm extractor

Model/Stock Number	Filter Media	Accu-Rated™ Airflow	Extraction Arm Diameter	Sound Level	Motor	Input Power	Dimensions	Net Weight without Arm
SWX-S (Self-Cleaning Model) (951620) Telescoping arm (951516) 7 ft. standard arm (951517) 10 ft. standard arm (951518) 12 ft. standard arm (951760) 10 ft. ZoneFlow arm (951761) 12 ft. ZoneFlow arm	SWX-D (Disposable Filter) (951619) Telescoping arm (951513) 7 ft. standard arm (951514) 10 ft. standard arm (951515) 12 ft. standard arm	490 sq. ft. (45.52 sq. m)	875 cfm (413 L/sec.)	8 in. (203 mm)	Standard: Approximately 75 dBA at 5 ft. (1.5 m) ZoneFlow: Approximately 80 dBA at 5 ft. (1.5 m)	1 hp, 3,450 rpm Blower motor: 115 V, 1-phase, 60 Hz at approximately 11.9 A ZoneFlow: 115 V, 1-phase, 60 Hz at approximately 12 A	SWX-S H: 33 in. (838 mm) SWX-D H: 29 in. (737 mm) W: 27.25 in. (692 mm) D: 33 in. (838 mm)	Cabinet: SWX-S: 195 lb. (88 kg) SWX-D: 130 lb. (59 kg) Blower/bracket: 95 lb. (43 kg)



FILTAIR® 4000-12000

See literature AY/3.4

The industrial centralized weld fume extractors are custom engineered solutions designed for multiple capture sources which require ducting and accessories to complete the system.



FILTAIR engineering resources. Design and engineering resources recommend, develop and support custom-engineered solutions.

Improves operating efficiency. Creates a cleaner shop with less downtime spent cleaning equipment.

Stand-alone space saver. Our fully assembled fume extractor provides up to a 65 percent smaller footprint versus traditional cartridge-style extractors. It provides all the necessary extraction tools, while offering customizable options.

Less noise. Up to 75 percent quieter than cartridge-style extractors. High-efficiency motors and integrated silencer housing create a quieter, more productive work area.

Integrated electrical controls. Control panel manages all of the collector functions, including fan, filter differential, and pulse cleaning system.



24 VDC motor start/stop feedback relay allows an external signal to automate the remote start of collector fan from other equipment.

FiTek XL filters

Easy-clean filter with surface-loaded filter technology allows for more effective weld fume pulse cleaning without penetration into the filter. This provides an easier filter cleaning process, while outlasting conventional cartridge filters.

Smaller size and fewer filters.

One FiTek XL filter replaces up to three cartridge-style filters increasing efficiency, reducing extractor size and lowering operational costs.



ZoneFlow™ arm additional features

EXCLUSIVE! ZoneFlow technology. Extends capture zone up to five feet versus 12 to 18 inches with conventional source capture arms. See below for more information.

Minimizes downtime with fewer fume extractor adjustments. With increased capture area, arm interactions are dramatically minimized.

Processes

- Stick (SMAW) ▪ Flux-cored (FCAW)
- MIG (GMAW) ▪ TIG (GTAW)

Custom solutions

- Configured to source fume extraction
- Configured for ambient push-pull collection

Comes with

- FiTek® XL filter
- Top **OR** front air inlet
- Configured for indoor **OR** outdoor mounting (outdoor models are wind load and seismic rated and include remote-mounted control box)

Most popular consumable



- **Replacement High-Efficiency Filter 300927**

Most popular accessories

- Extraction Arms (pg 103)
- Arm Mounting Bracket Kit (pg 103)
- Low Profile Hoods (pg 103)
- Call us toll-free at 866-931-9730 for information on factory options such as HEPA filter kit, weather hood, Spark Cooler® and integration services

IMPROVED! Now available with ZoneFlow technology.

FILTAIR 4000 model shown. Other models are available (6000, 8000, and 12000).

Call us toll-free at 866-931-9730 or email us at FILTAIR@millerwelds.com for information and requests for quotes on custom-engineered solutions to fit your needs.

*Based on clean filters. **Dimensions for base models without factory options.

Model	Nominal Airflow Range*	Number of Filter Packs	Sound Level	Input Power	Dimensions** (H x W x D)	Ship Weight
FILTAIR 4000	2,000-4,800 cfm (944-2,265 L/sec.)	4	72-75 dBA at 5 ft. (1.5 m)	230, 460 or 575 V, 3-phase, 60 Hz	86.1 in. (2,187 mm) 31.2 in. (792 mm) 83.2 in. (2,113 mm)	1,600 lb. (726 kg)
FILTAIR 6000	2,300-6,600 cfm (1,085-3,115 L/sec.)	6	Peak pulse cleaning is 92.7 dBA at 5 ft. (1.5 m)		117.2 in. (2,977 mm) 31.2 in. (792 mm) 83.2 in. (2,113 mm)	2,250 lb. (1,021 kg)
FILTAIR 8000	2,500-7,000 cfm (1,180-3,304 L/sec.)	8			135 in. (3,429 mm) 37.2 in. (945 mm) 83.2 in. (2,113 mm)	2,900 lb. (1,315 kg)
FILTAIR 12000	4,000-10,500 cfm (1,888-4,955 L/sec.)	12			120.3 in. (3,056 mm) 59.7 in. (1,516 mm) 83.2 in. (2,113 mm)	3,900 lb. (1,769 kg)

ZoneFlow™ Technology

The capture zone redefined. Innovative, extended-capture fume extraction system designed specifically for welding.

ZoneFlow technology extends the capture zone up to five feet deep and four feet wide (versus up to 18 inches from conventional source capture extractors). The increased capture zone reduces arm interactions so operators can keep welding, increasing arc-on time and productivity. Miller exclusive ZoneFlow technology is standard on the FILTAIR Capture 5, and optional on the FILTAIR SWX Series and FILTAIR 4000-12000 models (see pages 100, 101 and above).



Conventional

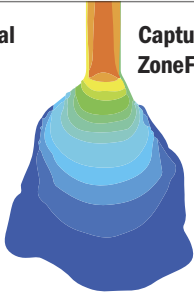

Capture 5 ZoneFlow

Extend your fume capture zone.

Conventional technology capture zone is 12-18 inches. ZoneFlow technology increases capture zone up to five feet and doesn't affect shielding gas or weld performance!



FILTAIR® 4000–12000 Accessories

See literature AY/3.7 (Extraction Arms) and AY/3.6 (Low Profile Hoods)

Miller offers a full line of accessories for complete system solutions and turnkey installation.



Telescoping arm Standard arm ZoneFlow arm Arm mounting bracket and ducting kit

Easy-to-operate, pre-assembled extraction arms and mounting equipment

- **Telescoping arms** are designed to fit small booth spaces used in training centers and educational booths. Telescopes from 3 to 4.5 feet with a wide range of motion to cover all positions
- **Standard arms** are designed to cover larger spaces and are available in 7-, 10- and 12-foot versions. External brackets and adjustments allow air to pass through with less resistance giving you stronger cfm (airflow)
- **ZoneFlow™ arms** are designed to cover larger spaces and are available in 10- and 12-foot versions. ZoneFlow arms extend the capture zone up to five feet versus 12 to 18 inches with conventional source capture arms. External brackets and adjustments allow air to pass through with less resistance giving you stronger cfm (airflow)
- **Arm mounting bracket and ducting kit** includes a supporting bracket and collar for connecting an extraction arm to ductwork

Model	6-Inch Diameter	8-Inch Diameter
Telescoping Arm	(301242) 3–4.5 ft. arm	(301237) 3–4.5 ft. arm
Standard Arm	(300953) 7 ft. arm (300954) 10 ft. arm (300955) 12 ft. arm	(300980) 7 ft. arm (300981) 10 ft. arm (300982) 12 ft. arm
ZoneFlow Arm with Motor Control Box	(951810) 10 ft. arm (951811) 12 ft. arm	(951758) 10 ft. arm (951759) 12 ft. arm
Arm Mounting Bracket and Ducting Kit	(300952)	(300771)

Spark Cooler®

- Cools sparks using the fume extractor's airflow
- Very efficient – maximizes the extractor's power
- Simple design is easy to install



FILTAIR low profile hood

- Available in sizes from 4 x 4 feet up to 16 x 16 feet in one-foot increments
- Exclusive design – capture velocity zone is maximized and distributed over the work area
- Hood airflow design reduces sound for better communication
- Unique airflow offers spark abatement in the extraction rail, as well as the recommended Spark Cooler
- Clear, UV-protected polycarbonate ceiling panels allow maximum light into the cell
- Corner lift hooks are convenient for installing or hanging over a work area. The hood can also be placed on an existing cell enclosure or supported with post assemblies

Call us toll-free at 866-931-9730 or email us at FILTAIR@millerwelds.com for information and requests for quotes on custom-engineered solutions to fit your needs.

Cleaner Air with FilTek® XL Filters

The FilTek XL filter's higher MERV rating means unrivaled filtering performance.

MERV Comparison

Applicable Weld Fume MERV Rating Categories ¹	Particle Size Range Efficiency % ²		
	0.3 to 1 µm	1 to 3 µm	3 to 10 µm
10	Not Rated	50–65%	85%
11	Not Rated	65–80%	85%
12	Not Rated	80–90%	85%
13	<75%	90%	90%
14	75–85%	90%	90%
15 Miller® FilTek XL	85–95%	90%	90%
16	≥95%	≥95%	≥95%
HEPA ³	≥99.97%	≥99.97%	≥99.97%
Weld Fume Composition ⁴	75–95%	≤15%	≤10%

¹American Society of Heating, Refrigeration and Air Conditioning Engineers (ASHRAE) 52.2

²National Air Filtration Association (NAFA) Guide

³HEPA filters are depth loading and have high restrictions to air flow, reducing system performance versus FilTek XL filters.

⁴Jenkins, Pierce, Edgar, Particle Size Distribution of GMAW and FCAW

Filters are rated on a MERV scale, which measures filter efficiency based on particle count. MERV ratings range from 1 to 16, with 16 being the best at filtering small particles – such as those found in weld fumes.

Filters in common air filtration systems often have MERV ratings from 7 to 11. FilTek XL filters are rated at class-leading MERV 15 to capture up to 95 percent of weld fume particulates.



Respiratory

Designed for comfort

Well-balanced design reduces torque on neck, increasing all-day wear.

Patent-pending Dualtec™ manifold system optimizes helmet balance and sound, while **six-point air distribution system** maximizes cooling through targeted air placement.

Ergonomic headgear provides secure fit without the need for over-tightening.

Lightweight low-profile blower assembly with integrated shoulder straps (PAPR) reduces lower back strain and fatigue.

Lightweight versatile C50 air regulator (SAR) can be positioned horizontally or vertically to naturally align with body movements.

Superior visibility

ClearLight™ Lens Technology optimizes contrast and clarity in welding and light states, easing eye strain.

Shade 5.0 side windows and oversized clear grind shield maximize downward and peripheral visibility, improving sense of surroundings.

Half-shade lens adjustability provides fine shade adjustment for optimized comfort and vision.

Improved productivity

Enhanced comfort, cooling and visibility maximize all-day wearability – increasing productivity, safety and regulatory compliance.

Low-profile breathing-tube attachment eases on/off process while flexible tube material reduces breathing tube snags in work cell.

Two lightweight lithium-ion batteries (PAPR) included with each package eliminate downtime.

C50 air regulator (SAR) supplies down to 50-degree Fahrenheit (28°C) Grade-D air under your hood, heightening productivity and relieving heat stress. Performance under different applications may vary. 360-degree swivel air hose connection alleviates hose coiling, reducing potential trip hazards.



PAPR Powered Air-Purifying Respirator See literature AY/4.1

Available packages:

With T94-R™ helmet (external grind control)

264573 With auto-darkening lens assembly

With T94i-R™ helmet (integrated clear grind shield)

264575 With auto-darkening lens assembly

With hard hat and Titanium 9400™ helmet (external grind control)

259385 With auto-darkening lens assembly

With hard hat and Titanium 9400i™ helmet (integrated clear grind shield)

261659 With auto-darkening lens assembly

T94-R™ helmet upgrade kit (for use with existing PAPR system)

279870 Includes T94-R helmet assembly, breathing tube, breathing tube cover and flowmeter

T94i-R™ helmet upgrade kit (for use with existing PAPR system)

279871 Includes T94i-R helmet assembly, breathing tube, breathing tube cover and flowmeter

A complete PAPR system consists of blower assembly, HEPA filter, prefilters (6), spark guard, breathing tube, breathing tube cover, padded belt, comfortable shoulder straps, lithium-ion batteries (2), battery charger, flowmeter, tool bag and helmet assembly (see available packages at left).

- HEPA filter provides up to 99.97 percent filtration of airborne particles
- NIOSH 42 CFR 84 certified, assigned protection factor of 25



Coiled air hose

Straight air hose

SAR Supplied Air Respirator See literature AY/4.3

Available packages:

With T94i-R™ helmet (integrated clear grind shield)

951800 With auto-darkening lens assembly and 25 ft. straight air hose

951801 With auto-darkening lens assembly and 100 ft. straight air hose

951802 With auto-darkening lens assembly and 25 ft. coiled air hose

951803 With auto-darkening lens assembly and 100 ft. coiled air hose

264871 With auto-darkening lens assembly (air hose not included)

T94i-R™ helmet upgrade kit (for use with existing SAR system)

279871 Includes T94i-R helmet assembly, breathing tube, breathing tube cover and flowmeter



Also available

BreatheAir™ Portable Box

275983 Two person, 10 ppm alarm

275985 Four person, 10 ppm alarm
Supplies Grade-D breathing air while monitoring for CO.

Monitor Calibration Kit

275988 10 ppm

A complete SAR system consists of C50 air regulator, belt assembly, flowmeter, breathing tube, breathing tube cover, tool bag, T94i-R helmet assembly and air hose (see available packages at left).

- NIOSH 42 CFR 84 certified, assigned protection factor of 25. To provide a NIOSH-approved respiratory system, the SAR with T94i-R must be used with Miller® helmet, hoses, connectors, filters and other components recommended by the manufacturer



Respiratory

NEW!



LPR-100 OV
with P100/OV filters



LPR-100
with P100 filters



N95

LPR-100™ OV Half Mask Respirator

See literature AY/4.5

ML00996 Respirator with P100 organic vapor filters (small/medium)

ML00997 Respirator with P100 organic vapor filters (medium/large)

Filters and accessories

SA00820 P100/OV filters (one pair)

285686 Protective hard carrying case

261086 Quantitative fit-test kit adapter

- Low-profile design fits under T94™ and Digital Elite™ Series welding helmets and provides maximum field of vision
- P100/OV filters provide up to 99.97 percent filtration of specific organic vapors and airborne particulates
- NIOSH 42 CFR 84 certified, assigned protection factor of 10

LPR-100™ Half Mask Respirator

See literature AY/4.5

ML00894 Respirator with P100 filters (small/medium)

ML00895 Respirator with P100 filters (medium/large)

ML00994 Respirator with P100 nuisance level OV relief filters (small/medium)

ML00995 Respirator with P100 nuisance level OV relief filters (medium/large)

Filters and accessories

SA00818 P100 filters (one pair)

SA00819 P100 nuisance level OV relief filters (one pair)

283374 Protective hard carrying case

261086 Quantitative fit-test kit adapter

- Low-profile design fits under T94™, Digital Elite™ and Classic Series welding helmets and provides maximum field of vision
- P100 filters provide up to 99.97 percent filtration of airborne particles
- Nuisance level OV relief filters are designed for use with organic vapor concentrations not exceeding OSHA's PELs or other applicable government occupational exposure limits, whichever is lower
- NIOSH 42 CFR 84 certified, assigned protection factor of 10

N95 Disposable Mask Respirator

See literature AY/4.8

267334-2 Respirator (2 pack)

267334 Respirator (10 pack)

267335-2 Respirator with nuisance level OV relief (2 pack)

267335 Respirator with nuisance level OV relief (10 pack)

- Flame-retardant outer layer designed for welding applications
- N95 filters provide up to 95 percent filtration of airborne particles
- Nuisance level OV relief filters are designed for use with organic vapor concentrations not exceeding OSHA's PELs or other applicable government occupational exposure limits, whichever is lower
- NIOSH 42 CFR 84 certified, assigned protection factor of 10

MillerWeldsStore.com



Buy Miller® Gear Online. Shirts, hats, mugs, banners and more!



Welding Helmets

See page 108 for helmet accessories.



Serious dependability backed with a three-year warranty (unless noted).

	T94i™	T94™	Digital Infinity™	Digital Elite™	Digital Performance™	Classic VSI™	Classic VS	Classic FS#10 Flip-Up
Viewing Area	9.2 sq. in.	9.2 sq. in.	13.4 sq. in.	9.2 sq. in.	7.2 sq. in.	5.9 sq. in.	5.2 sq. in.	5.1 sq. in.
Auto-Darkening	Yes	Yes	Yes	Yes	Yes	Yes	Yes	Yes
ClearLight™ Lens Technology	Yes	Yes	Yes	Yes	Yes	—	—	—
AutoSense™	—	—	Yes	Yes	—	—	—	—
Shades	Cut: 5-8 Weld: 8-13	Cut: 5-8 Weld: 8-13	Cut: 5-8 Weld: 8-13	Cut: 5-8 Weld: 8-13	Cut: 5-8 Weld: 8-13	8-13	8-12	10
Modes	Weld/Cut/X-Mode/ Flip grind	Weld/Cut/X-Mode/ External grind	Weld/Cut/X-Mode/ Grind	Weld/Cut/X-Mode/ Grind	Weld/Cut/ Grind	Weld/X-Mode/ Flip grind	Weld	Weld/ Flip grind
Integrated Grind Shield	Yes	—	—	—	—	Yes	—	Yes
Auto-on	Yes	Yes	Yes	Yes	Yes	Yes	Yes	Yes
Sensors	4	4	4	4	3	3	2	2
TIG Rating	3 amps	3 amps	5 amps/below	5 amps/below	5 amps	5 amps/below	20 amps	20 amps
Switching Speed	1/20,000 second	1/20,000 second	1/20,000 second	1/20,000 second	1/20,000 second	1/20,000 second	1/12,000 second	1/3,600 second
Digital Controls	Yes	Yes	Yes	Yes	Yes	—	—	—
Premium Headgear	Yes	Yes	Yes	Yes	Yes	—	—	—
InfoTrack™	Yes - 2.0	Yes - 2.0	Yes - 1.0	—	—	—	—	—
Weight	26 oz. (737 g)	21 oz. (599 g)	23 oz. (652 g)	18 oz. (510 g)	17 oz. (482 g)	23 oz. (652 g)	16 oz. (454 g)	14 oz. (396 g)
Warranty	3 years	3 years	3 years	3 years	3 years	2 years	2 years	2 years

See chart above for feature availability.

Largest viewing area. Digital Infinity™ Series helmets feature a 13.4-square-inch viewing area allowing for a wide range of view.

ClearLight™ Lens Technology optimizes contrast and clarity in welding and light states. 1/1/1/2 optical clarity rating allows for a lighter light state while not welding, maximizing safety and productivity.

AutoSense™ eliminates issues related to setting helmet sensitivity by allowing the welder to push and hold the AutoSense button to automatically set the helmet sensitivity for their environment.

X-Mode™ Electromagnetically senses the weld to eliminate sunlight interference and continuously detects the arc even if sensors are blocked.

Premium headgear. Features ample adjustability settings and enhanced support for the perfect fit, maximizing comfort.

InfoTrack™ data monitoring technology tracks arc time and features a clock. Version 2.0 adds arc count.

T94™ Series Maximized comfort, visibility and productivity for the professional welder. See literature AY/41.1



Industry's largest integrated grind shield (44 sq. in)

T94i™ 260483



External grind control

T94™ 260482

Matte silver finish reflects ambient heat, keeping the user cooler.

Four operating modes for ultimate versatility: weld, cut, grind and X-Mode™.

Half shade settings for precise lens adjustment.

Simplistic digital lens interface allows for easy adjustment with or without gloves.

Shade 5.0 side windows enhance peripheral vision, amplifying sense of surroundings.

Chiseled shell design provides optimal skin coverage while easily accommodating a Miller® Half Mask Respirator.

Gen IV premium headgear with four-point flexible design provides a secure fit, while avoiding major pressure points within the head, maximizing all-day wear. Customizable fit with seamless tilt, distance and tightness adjustments.

InfoTrack™ 2.0 monitors arc time and arc count.

Best-in-class comfort for all-day wearability

Lightweight, well-balanced design reduces neck torque, minimizing operator fatigue and strain, leading to an increase in comfort.



4% LIGHTER for reduced fatigue



14% BETTER BALANCE for elevated comfort



17% LESS TORQUE for reduced neck strain

Statistics above compare T94i to previous model.

Helmet Lighting Accessory 281361

- Provides additional lighting in low-light environments for T94 Series helmets
- Includes two lights (one for each side) and all required mounting hardware





Digital Infinity™ Series Largest viewing area maximizes visibility. See literature AY/42.0



Black
280045

Black Ops™
280047

Departed™
280048

Stars and Stripes™
280049

Relic™
280051

NEW! **Imperial™**
280053

Cat® 2nd Edition
282007

Digital Elite™ Series Industry-leading helmet provides high-performance versatility. See literature no. AY/43.0



Black
281000

Lucky's Speed Shop™
281001

Stars and Stripes™ III
281002

Inferno™
281003

Vintage Roadster™
281004

Raptor™
281007

Cat® Edition 1
281006

Digital Performance™ Series See literature AY/44.0

Lightweight helmet with superior headgear for ultimate comfort.



Black
282000

Blue Rage™
282001

'64 Custom™
282002

NEW! **Crusher™**
282005

Helmet Lighting Accessory 282013

- Provides additional lighting in low-light environments for most Miller helmets including Titanium, Infinity, Elite, Performance, Classic and MP-10
- Includes two lights (one for each side) and all required mounting hardware



Classic Series Helmets for the value-minded welder. See literature AY/45.0



VSI™
260938

FS#10 Flip-Up
263038

Black (VS)
251292

Metalworks™ (VS)
271346

Rise™ (VS)
271349

NEW! **Liberty™**
287369

MP-10™ Helmet

Best-in-class traditional passive shade 10 lens helmet.



Black
238497



©2019 Caterpillar. CAT, CATERPILLAR and their design marks are registered trademarks of Caterpillar. Miller Electric Mfg. LLC is a licensee of Caterpillar Inc.



Helmet Accessories



Gen 3.5 Headgear 284218

- Ergonomic design with comfort cushion provides extensive adjustability, settings and enhanced support



Gen IV Headgear 260486

- Ergonomic, four-point flexible design provides a secure fit, while avoiding major pressure points within the head – for the T94™ Series helmets



Slotted Hard Hat Adapter 259637

- Compatible with most slotted hard hats. Helmet and hat not included



Hard Hat Adapter 265315

- T94 Series 222003 Titanium, Infinity™, Elite™, Performance™ and Classic Series, and MP-10™
- Compatible with most Fibre Metal and MSA hats. Other brands may fit depending on size and shape. Helmet and hat not included



2x4 Auto-Darkening Lens

- 770660 Shade 8
- 770659 Shade 9
- 770226 Shade 10
- 770961 Shade 11
- Fits all 2x4-inch windows
- Solar powered
- Two arc sensors
- Light state shade 3
- Two-year warranty



Helmet Bib 253882

- Flame-resistant WeldX™ material provides additional neck coverage for the Infinity, Elite, Performance and Classic Series helmets, and MP-10 helmet



Helmet Bib 279078

- Flame-resistant material provides additional neck coverage for the T94 Series helmets



Helmet Cape 279080

- Flame-resistant material provides additional head and back-of-the-neck coverage for the T94 Series helmets



Helmet Hook 251018

- Holds welding helmets, grinding shields or other helmets with a headgear
- Silicone strap secures the helmet in place



Jobsite Tool Bag 228028

- Over twenty separate pockets
- Opening of 12 x 18.5 inches (305 x 470 mm)



CoolBelt™ Belt-Mounted Cooling System 245230

- Up to **17 degrees Fahrenheit cooler** under the hood
- Provides all-day comfort through maximized airflow power
- Multiple airflow speeds eliminate stagnant air and reduce fogging
- Lightweight design extends wearability
- Compatible with Infinity, Elite, Performance and Classic Series helmets, and MP-10 helmet

Weld-Mask™

See literature AY/40.0



Compact auto-darkening lenses allow users to weld in spaces where access with traditional welding helmets is limited. Close-fitting soft eye covering provides total darkness for precision welding. Face shield and flame-retardant head cover provide coverage for UV/IR rays and applications with limited spatter.



Weld-Mask

Weld-Mask 2



Weld-Mask 2 Lighting Accessory 281188

- Snaps onto brow of Weld-Mask 2 model to provide additional lighting in low-light environments

Weld-Mask Hard Hat Adapters 285757

- Snaps onto sides of most slotted hard hats to secure Weld-Mask

Weld-Mask 267370

- Shades 5, 7, 9, 11 and 13 for use with MIG, TIG, stick, and gas welding and cutting
- Extremely lightweight (8 oz.), virtually eliminates neck strain

Weld-Mask 2 280982

- Ideal for industrial or construction environments – can be worn under a hard hat with a Miller® Half Mask Respirator and select safety glasses
- Shades 5–13 for use with MIG, TIG, stick, and gas welding and cutting
- X-Mode™ electromagnetically senses the weld to eliminate sunlight interference and continuously detects the arc even if sensors are blocked
- Wide, singular lens provides unmatched auto-darkening range of visibility

Safety Glasses

See literature AY/46.0



Classic



Slag



Spark



Spatter



Gen I

- Anti-fog coating and high-quality optics
- Form-fitting orbital eye coverage
- Shatterproof polycarbonate lenses
- Wrap-around designs meet ANSI side shield requirements

- ANSI Z87.1+ compliant
- I/O (indoor/outdoor) lenses feature light shading with a mirrored finish
- Shade 3 and 5 IR lenses are for cutting, brazing or soldering

Safety and Cutting Glasses Chart

Frame Style (Color)	Clear Lenses	I/O Lenses	Shade 3 Lenses	Shade 5 Lenses
Classic (Black)	272187	–	–	–
Spatter™ (Black)	272191	–	–	–
Spark™ (Black/Blue)	272190	–	–	–
Slag™ (Black)	272201	272202	–	272205
Gen I (Black)	–	–	235662	235658



Welding Apparel

See literature AY/47.5



Grain Leather Jacket (See size chart)

- Top-grain pigskin leather
- Expandable leather strategically placed for optimal mobility
- Flame-resistant inside cuff
- Satin lining
- Tapered, athletic cut
- Sewn entirely with Kevlar® thread, adding structural durability at each seam



Split Leather Jacket (See size chart)

- Premium pig split leather
- Extended rear tail for additional protection
- Expandable leather strategically placed for optimal mobility
- Mesh lining
- Sewn entirely with Kevlar® thread, adding structural durability at each seam



WeldX™ Jacket (See size chart)

- 7-ounce WeldX front and flame-resistant navy cotton back
- Lightweight exclusive material with extreme flame-resistant properties
- Vented back/extended rear tail
- Zipper closure with hook-and-loop fastened flap
- Chromium free



Combo Jacket (See size chart)

- 9-ounce Indura® flame-resistant cotton (flame resistance guaranteed for life of jacket)
- Top grain leather
- Pre-shrunk fabric



Indura® Cloth Jacket (See size chart)

- 9-ounce Indura® flame-resistant cotton (flame resistance guaranteed for life of jacket)
- Pre-shrunk fabric



Classic Cloth Jacket (See size chart)

- 9-ounce flame-resistant navy cotton
- Pre-shrunk fabric
- Fold-in sleeve snaps
- Finished hems and reinforced stitching



Leather Bib/Apron 231125

- Attaches to combo jacket with snaps across the chest as a bib or along the bottom as an apron



Combo Sleeves 231096

- Indura® flame-resistant cotton/top grain leather
- 21-inch length



Classic Cloth Sleeves 247148

- 18-inch length
- Fold-in sleeve snaps
- Upper arm elastic band



Classic Cloth Apron 247149

- 35-inch length with accessible front pocket
- Adjustable drawstring ensures a good fit

Welding Apparel Size Chart

Apparel	Small	Medium	Large	X-Large	2X-Large	3X-Large	4X-Large	5X-Large
Grain Leather Jacket	—	—	231090	231091	231092	—	—	—
Split Leather Jacket	273212	273213	273214	273215	273216	273217	273218	273219
WeldX Jacket	247114	247115	247116	247117	247118	247119	247120	247121
Combo Jacket	—	231081	231082	231083	231084	—	—	—
Indura Cloth Jacket	—	258097	258098	258099	258100	—	—	—
Classic Cloth Jacket	244749	244750	244751	244752	244754	244755	244756	244758



Welding Gloves

See literature AY/47.0

Performance – unprecedented comfort and performance with exceptional dexterity and flexibility.



Heavy-Duty MIG/Stick

- Strategically placed patches on palm and back for extended glove life
- Double-layered insulated palm and back
- Pig grain leather palm provides extreme durability and protection



MIG (Lined)

- Dual-padded palm
- Fleece-insulated palm, foam-insulated back
- Cow grain palm, pig split back and goat grain inner fingers provide exceptional dexterity and comfort



TIG

- Completely unlined for heightened feel and dexterity
- Triple-padded palm for added comfort
- Goat grain leather offers superior flexibility and dexterity



TIG/Multitask

- Dual-padded palm for added comfort
- Wool back provides ultimate insulation
- Goat grain leather offers superior flexibility and dexterity



Metalworker

- Durable top grain leather and spandex back for enhanced durability and dexterity
- Neoprene wrist with hook-and-loop closure increases fit and support
- Padded, reinforced palm and thumb saddle for extended wear

Classic – traditional design for the value-minded welder.



Heavy-Duty MIG/Stick

- Reflective insulation on back reduces heat impact
- Moisture-wicking fleece and foam insulation
- Pig grain palm, pig split back and cuff



MIG (Pigskin)

- Reinforcement patches enhance durability
- Moisture-wicking fleece and foam insulation
- Pig split leather palm, back and cuff



MIG (Cowhide)

- Reinforcement patches enhance durability
- Moisture-wicking fleece and foam insulation
- Cow split palm, pig split back and cuff



TIG

- Thin internal padding for added comfort
- Unlined palm for precise dexterity
- Sheep grain palm, cow split back and cuff



Work

- Dual-padded palm for added durability
- Fleece back provides ultimate insulation
- Cow grain leather offers superior durability and abrasion resistance

Welding Glove Size Chart *All asterisked stock numbers are sold as one pair. All others are sold as six packs (six pairs).

Performance Gloves	Small	Medium	Large	X-Large	2X-Large	Classic Gloves	Medium	Large	X-Large
Heavy-Duty MIG/Stick	–	–	263339	263340	269615*	Heavy-Duty MIG/Stick	–	271877*	271887*
MIG (Lined)	–	263332	263333	263334	269618*	MIG (Pigskin)	–	279875*	279876*
TIG	263346	263347	263348	263349	–	MIG (Cowhide)	–	271890*	271891*
TIG/Multitask	263352	263353	263354	263355	–	TIG	279897*	279898*	279899*
Metalworker	–	251066	251067	251068	–	Work	266041*	266042*	266043*

Miller recommends



Innovation

Focused on optimizing quality, ease-of-use and cost

Collaboration

Partnering to meet customer needs

Trusted source

Deep product and application expertise to deliver success

Visit HobartBrothers.com for more information.

More than just filler metal... SOLUTIONS for your business.



For more detailed information, visit

MillerWelds.com/arcstation

Workstations



Count on Miller to design the perfect workbench to make welding projects faster and easier. The ArcStation is the first-ever, all-in-one workstation designed for welding and metalworking. It's versatile, affordable and just the right height to work comfortably. You can organize equipment, tools, and raw materials into one convenient workspace.

ArcStation™ 60SX Fully Loaded

The 60SX Fully Loaded is perfect for the welder who needs a tough workbench for the fab shop or the home garage.



60SX Fully Loaded

30 x 60 inch size tabletop provides double the work surface of the 30FX.

3/8-inch X-pattern steel tabletop allows trouble-free clamping.

Durable 1/8-inch steel frame with cross bar and heavy-duty tabletops provide a sturdy area for welding or metalworking.

Adjustable leveling feet keep workbench rock-steady.

Comes customized with a wide range of handy accessories to make this the *ultimate* workbench (see at right for replacement accessories).

ArcStation 60SX accessories

Miller ArcStation accessories allow you to get the most out of your ArcStation.

- 1 6-inch X-clamp** 300613
- 2 Side Shelf** 300680
- 3 Tool Chest** with ball-bearing slides 300610
- 4 5-inch Quick-remove Vise** 300611 With mount
- 5 Weld Curtain** 300686
- 6 Casters** 300849



Convenience Kit 300614
Includes the following:

- 7 Gun holder**
- 8 Tool holder**
- 9 Clamp bar**



Visit MillerWelds.com or your distributor for other Miller® options and accessories.

ArcStation™ 30FX

When portability or space-savings is a concern, the ArcStation 30FX is your solution.



30FX shown with two 6-inch X-clamps (sold separately).

Wheels, handle, and fold-up design make unit easy to take to the jobsite or move around the shop.

Compact size makes storing unit a breeze. Unit folds down to 6 x 29 x 48 inches (152 x 737 x 1219 mm).

30 x 30 inch size tabletop provides plenty of work surface.

3/16-inch X-pattern steel tabletop allows trouble-free clamping.

1.5-inch diameter steel tube frame provides strength and durability.

Includes removable gun holder.

Add optional 6-inch X-clamp (300613) to make this the *ultimate* portable workbench.

Model/Stock Number	Steel Top	Load Capacity	Dimensions	Weight
60SX Fully Loaded (951793)	(1) 29 x 29 x 3/8 in. solid, (1) 29 x 29 x 3/8 in. X-pattern	1,000 lb. (454 kg)	35 x 58 x 29 in. (889 x 1,473 x 737 mm)	318 lb. (144 kg)
30FX (300837)	(1) 29 x 29 x 3/16 in. X-pattern	500 lb. (227 kg)	35 x 29 x 35 in. (889 x 737 x 889 mm)	74 lb. (34 kg)



Training Solutions

For more detailed information, visit



MillerWelds.com/trainingsolutions

From our FREE OpenBook™ training software, to our AugmentedArc® augmented reality welding system and LiveArc™ welding performance management system, we provide solutions to meet all of your welding training needs.



OpenBook provides FREE interactive online training resources, educational materials and tracking tools. These materials allow welding instructors to assign and deliver welding content, create quizzes, download welding labs, monitor student participation, and assess and report student progress and performance. Visit OpenBook.MillerWelds.com for details.

Customize your classroom

▪ Implement materials that fit your curriculum and learning objectives, including:

- e-Learning modules
- Weld lab activities
- Course builder
- Quiz builder
- Lab builder

▪ Track individual student progress

▪ All material aligns with AWS standards

Motivate and engage students

▪ Interactive, stimulating learning includes videos and activities

▪ Quick, digestible segments

▪ Mobile friendly

- Easy to access homework from anywhere
- Students can check grades and status

▪ Ideal for high school and post-secondary welding programs

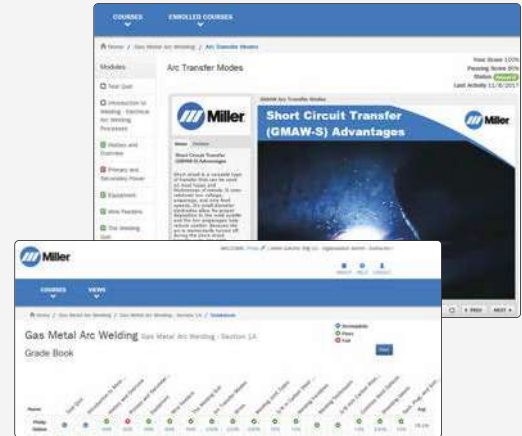

AugmentedArc® Augmented Reality Welding System

LiveArc™ Welding Performance Management System



The AugmentedArc augmented reality welding system allows students and trainees to experience the most realistic multiprocess welding simulation available – and then seamlessly transition to the industry's most complete live arc experience in the LiveArc welding performance management system.

Delivering unbeatable advantages

- Optimize instructor efficiency
- Deliver real-time feedback
- Reduce overall training time
- Assess weld operator skills and performance
- Minimize material cost
- Enhance job candidate recruiting and screening
- Build a larger, more-skilled welding workforce

AugmentedArc® Augmented Reality Weld Training

See literature TS/2.0

The industry's most realistic welding simulation solution for classroom training.

Only available at approved distributors!



IMPROVED!

Lighter in weight and better balanced AR welding helmet with larger viewing area, plus a more realistic augmented reality environment.

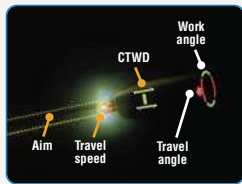

Optimize instructor efficiency by using the Teacher software to create a virtual classroom with customized curriculum, quizzes and weld exercises.

Real-time feedback is provided on users' technique to help correct errors. Reinforce proper welding practices and accelerate skill advancement prior to actual live arc welding in a lab.

Reduce overall training time. Compared to traditional methods, AugmentedArc significantly reduces the amount of time needed to teach students.

Minimize material cost by saving wire, gas and workpieces in this simulation environment, while allowing students to define their welding skills before live arc welding.

Build a larger, more-skilled welding workforce when computer-savvy individuals are drawn to welding education programs that increase their success.

AugmentedArc system comes complete with

- AugmentedArc simulator
- Teachers software
- Black Infinity™ AR helmet with premium headgear
- AugmentedArc router
- MIG gun with AR nozzle
- SMAW stinger
- TIG torch with AR nozzle
- Two electrode/filler rods with AR tips
- Work stand for out-of-position applications
- Five workpieces: t-joint, butt joint, lap joint, pipe-to-plate and butt pipe

Optional components

NEW!



- **TIG Foot Pedal Kit 286033**
Includes TIG foot pedal, connection cable and adapter cable
- **AugmentedArc Controller 301395**
For multiple system connectivity
- **Heavy-duty Transportation Cases 951775**
Protects complete system during transportation or storage – one case holds the simulator and the other holds accessories

Stock Number	Input Power	Voltage/Amperage Selection	Welding Positions	Polarity Selection	Shielding Gas Selection	Wire Speed Selection	Base Material Selection	Workpiece Selection	Stick Electrode Selection	Diameter Selection	Simulator Dimensions	Net Weight
(951823) Only available at approved distributors	115 V, 15 A, 60 Hz	GMAW: 10-38 V, 50-425 A FCAW: 10-38 V, 50-425 A SMAW: 50-425 A GTAW: 50-425 A	1F-4F, 1G-6G	DCEP, DCEN, AC	CO ₂ , Argon O ₂ , Argon CO ₂ , Argon	GMAW/FCAW: 50-1,000 ipm (1.27-25.4 m/min.)	Carbon steel, Stainless steel, Aluminum	1/8, 1/4, 3/8 in. (3.2, 6.4, 9.5 mm)	E7018, E6010, E6013	Solid wire: .030, .035, .045 in. (0.8, 1.0, 1.2 mm) Stick electrode: 1/8, 3/32, 5/32 in. (2.5, 3.25, 4.0 mm) Filler rod: 5/64, 3/32 in. (2.0, 2.4 mm)	H: 21 in. (533 mm) W: 9.38 in. (238 mm) D: 17.25 in. (438 mm)	Simulator: 20.7 lb. (9.4 kg) Helmet: 1.97 lb. (0.9 kg)

LiveArc™ Welding Performance Management System

See literature TS/1.0

Only available at approved distributors!

GMAW/FCAW/SMAW system shown.



The reality-based recruiting, screening, training, and re-qualification solution for industrial, manufacturing and educational markets.

Better and more cost effective training with faster results. Benefit from both weld simulation and the real-world experience of live arc welding with instant, valuable feedback on welding technique to quickly help build skills.

Motion-tracking technology measures the operator's adherence to preset technique parameters. Cameras track the movement of LEDs embedded in the MIG SmartGun and SMAW SmartStinger during pre-weld simulations and live welds; the system then delivers visual feedback on the operator's performance via the LiveArc system's main display.



LiveArc GMAW/FCAW system comes complete with

- Computer with Intel core i7, 128 GB SSD, fanless cooling, and HDMI port for connection to most secondary monitors (not included)
- 21.5 HD LCD touch screen monitor
- SmartGun with 15 ft. (4.6 m) cable
- Calibration tool
- Two table clamps
- Removable arm extension with C-clamp assembly for out-of-position right- and left-hand applications
- Extra Bernard® consumables

LiveArc GMAW/FCAW/SMAW system includes above plus

- SmartStinger with 12 ft. (3.7 m) cable
- 15 ft. (4.6 m) Dinse-style cable
- Router box
- Software update for SMAW applications

Stock Number	Input Power	Processes	Positions	Multi-Pass	Rated Output	Electrode Diameter	Dimensions	Net Weight
(907714) GMAW/FCAW system (907714001) GMAW/FCAW/SMAW system Only available at approved distributors	120 V, 60 Hz Compatible with Miller power sources	GMAW, GMAW-S, GMAW-P, FCAW-G SMAW	2F-4F, 1G-4G	Groove and fillet up to 1 in. (25 mm) plate Limited groove applications	SmartGun: 400 A at 60% duty cycle (mixed gases) SmartStinger: 250 A at 60% duty cycle	SmartGun: Up to 5/64 in. (2.0 mm) SmartStinger: Up to 1/8 in. (3.2 mm)	H: 77.5 in. (1,969 mm) W: 46 in. (1,168 mm) D: 31 in. (787 mm)	GMAW/FCAW system: 480 lb. (218 kg) GMAW/FCAW/SMAW system: 527 lb. (239 kg)

Automated MIG 114

Cable Connectors and Adapters 114/121

Carts, Cylinder Racks and Running Gear 114-116

Coolant Systems 115

Engine Drive Accessories 116-117

- Big Blue Accessories ▪ Blue Star Accessories
- Bobcat and Trailblazer Accessories
- Generator Accessories ▪ Protective Covers ▪ Trailers

Automated MIG

For adapters and drive motors, visit MillerWelds.com.



Coolant Flow Switch 195461

For water-cooled guns. To ensure coolant is flowing in the system. A lack of coolant flow may cause damage to water-cooled guns.

Module allows wiring into the peripheral connector port. 50-foot (15.2 m) cable with connector and separate shell connector for simple modification to desired length in the field. Quarter-turn quick connection.

Cable Connectors and Adapters

Also see *Torch and Weld Cable Connectors in TIG Accessories on page 121.*

For AlumaFeed system, Invision 352 MPa, XMT 350, CST, Maxstar, Dynasty and Syncrowave. These power sources are equipped with Dinse- or Tweco-style connectors for secondary connections. Power sources are shipped with two male plugs for use with #4 to #1/0 AWG cable.

Dinse-Style Connector Kits

042418 Accepts #4 to #1/0 AWG cable

042533 Accepts #1/0 to #2/0 AWG cable

Kits include one male Dinse-style plug which attaches to the work and/or weld cables and plugs into the Dinse-style receptacles on the power source.

Extension Kit for Dinse-Style Cable Connectors

042419 Accepts #4 to #1/0 AWG cable

Used to adapt or extend weld and/or work cables. Kit includes one male Dinse-style plug and one in-line female Dinse-style receptacle.

Extensions for Dinse-Style Cable Connectors

134460 Male Dinse-style plug

136600 Female Dinse-style receptacle

Used to adapt or extend weld and/or work cables.

Accepts #1/0 to #2/0 AWG cable.



Tweco-Style Connector 191981

Accepts #1/0 to #2/0 AWG cable. Kit includes one Tweco-style male plug which attaches to the work and/or weld cables and plugs into the Tweco-style receptacles on the power source.



Dinse/Tweco Adapter 042465

Dinse/Cam-Lok Adapter 042466

One-piece adapter with Dinse-style male plug (to power source) on one end and Tweco or Cam-Lok female receptacle (for weld cable connection) on other end.

Load Banks 117

MIG Accessories 117

- Machine and Gun Accessory Kits ▪ Protective Covers

Plasma Cutter Accessories 118

- Automation Kits ▪ Cables and Cable Covers
- Cutting Guides ▪ Filters ▪ Plugs and Cords
- Protective Case ▪ Torches

Polarity Switches/Controls 119

Remote Controls and Wireless Remote Controls 119-121

Tweco®/Dinse Adapter 210061

One-piece adapter with Tweco-style male plug (to power source) on one end and Dinse-style female receptacle (for weld cable connection) on other end.

Carts, Cylinder Racks and Running Gear

Also see *Engine Drive Accessories on page 116.*



Feeder Cart 142382

A low-profile, creeper cart which allows the operator to easily move the feeder around the work area.



Universal Cart and Cylinder Rack 042934

For Invision 352 MPa, XMT 350, CST, Diversion, Maxstar 210/280 and Dynasty 210/280.

Also accommodates a single gas cylinder up to 56 inches (1,422 mm)

high measuring 6 to 9 inches (152 to 229 mm) in diameter. Provides storage for auxiliary items such as electrodes, helmets and gloves.



Running Gear/Cylinder Rack 301239

For Millermatic 141/211, Multimatic 200/215 and Diversion.

Heavy-duty construction with 8-inch rubber rear wheels, convenient front handles, cable holders and plastic consumable box. For gas

cylinders no greater than 7 inches (178 mm) in diameter or 65 pounds (29.5 kg) in weight.



Dual Cylinder Rack Cart 951770

For Millermatic 141/211, Multimatic 200/215/220 AC/DC and Diversion. Similar to Running Gear/Cylinder Rack 301239, but with dual-cylinder rack and a bracket that holds a variety of tools.

Dual Cylinder Rack Conversion Kit and Tool Holder (301454) is also available separately for use with Running Gear/Cylinder Rack above.

Stick Accessory Kits 119

Submerged Arc Accessories 119

- Cables ▪ Torch Accessories
- Wire Drive Assembly Accessories

TIG Accessories 120-121

- Kits ▪ Protective Case/Covers ▪ Remote Controls
- Torch and Weld Cable Connectors

Wire Feeder Accessories 122

- Extension Cables (14-pin) ▪ Power Supply Adapter
- Spool Adapter ▪ Spool Gun Controls and Kits
- Turntable Assembly ▪ Wire Straightener



Dual EZ-Change™ Low Cylinder Rack with Elevated Gun and Cable Rack 300337

For Millermatic 212 Auto-Set/252 and Syncrowave 210.

Allows operators to easily roll cylinders on and off the rack with no lifting and keeps cables off the floor and tangle free. Elevated Gun and Cable Rack (300335)

is also available separately for use with factory-installed single-cylinder rack.



EZ-Latch™ Single Cylinder Running Gear 301449

For Millermatic 255 and Multimatic 255.

Running gear with a single-cylinder rack and storage compartment. Machine is secured to cart by latches that rotate to disengage machine for easy portability.



EZ-Latch™ Dual Cylinder Rack Running Gear 951769

For Millermatic 255 and Multimatic 255.

Similar to above, but with a dual-cylinder rack and elevated gun/cable rack to keep cables off the floor and tangle free. EZ-Latch Dual Cylinder Rack with Elevated Gun and Cable

Rack (301481) is also available separately for use with EZ-Latch Single Cylinder Running Gear above.



Dual Cylinder Rack 195299

For Millermatic 350P/350P Aluminum. Replaces single-cylinder rack.



MIGRunner™ Cart 195445

For AlumaFeed system or Invision and XMT with single-wire feeders. Small footprint and easily maneuverable, with a dual-cylinder rack low enough that you do not have to lift bottles. Durable, heavy-duty ergonomic handles are designed for comfort.



Deltaweld 350/500 Running Gear 301523

For Deltaweld 350/500. Features small footprint, dual-cylinder rack, chains for gas cylinders, ergonomic handle design and lockable front casters with two torch holders, and storage area below.



2-Wheel Trolley Cart 300971

For Maxstar 210/280 and Dynasty 210/280 with or without Coolmate 1.3. Easy-to-maneuver two-wheel cart features single-cylinder rack, chain for cylinder, straps (quick and easy to detach and carry machine), cable holders, torch holder, storage area, and filler rod storage area.



Running Gear Cylinder Rack 300408

For Invision, Dimension 650, and XMT with single- or dual-wire feeders. Holds two large gas cylinders and has gun cable hangers and a consumable drawer in front. A convenient handle allows the cart to be pulled easily through doorways. Power source and single- or dual-wire feeders can be mounted to cart and secured.



Continuum Running Gear/Cylinder Rack 301264

For Continuum. Small footprint and easily maneuverable, with cylinder rack low enough that you do not have to lift bottles.



Small Runner™ Cart 301318

For Maxstar 210/280 and Dynasty 210/280 with or without Coolmate 1.3. Cart features single-cylinder rack, foot pedal holder, two cable/torch holders and two TIG filler holders.



Runner™ Cart 300244

For Maxstar 400/800 and Dynasty 400/800 with or without Coolmate 3.5. Cart features single-cylinder rack, foot pedal holder, three cable/torch holders and two TIG filler holders.

Coolmate™ Coolant Systems

See literature AY/7.2



Coolmate 1.3

Coolmate 3

Coolmate 3.5

Coolmate 4

Coolmate 1.3 300972 120 V

For Maxstar 210/280 and Dynasty 210/280. Light industrial, 1.3-gallon cooler designed for water-cooled torches on power sources rated up to 280 amps*.

Coolmate 3 043007 120 V 043008 240 V

Economical, 3-gallon cooler designed for water-cooled torches rated up to 500 amps*.

Coolmate 3.5 300245 120 V

For Maxstar 400/800 and Dynasty 400/800. Industrial, 3.5-gallon cooler designed for water-cooled torches rated up to 600 amps*.

Coolmate 4 042288 120 V

Best performer in its class – industrial, 4-gallon cooler designed for water-cooled torches rated up to 600 amps*.

*May vary with torch design and cable length. Miller coolant systems are backed by the best warranty in the industry – one full year.

Coolant

Sold in multiples of four in 1-gallon recyclable plastic bottles. Miller® coolants contain a base of ethylene glycol and deionized water to protect against freezing to -37 degrees Fahrenheit (-38°C) or boiling to 227 degrees Fahrenheit (108°C).



Low-Conductivity Coolant (clear, pre-mixed) 043810

For TIG and MIG applications. NOT for use in push-pull systems or systems where aluminum is in coolant path/circuit.

Aluminum-Protecting Coolant (green, pre-mixed) 043809

Primarily used in push-pull systems where aluminum is in coolant path/circuit and high frequency is NOT used.

Model	Motor Input Voltage	Maximum Current Draw	Maximum Cooling Capacity	IEC Cooling Capacity	Tank Capacity	Dimensions	Net Weight
Coolmate 1.3	115 V, 60 Hz	4.7 A (60 Hz)	3,400 W (11,600 Btu/hr.) 3.8 qt./min. (3.6 L/min.)	1,330 W (4,540 Btu/hr.) 1.1 qt./min. (1 L/min.)	1.3 gal. (4.9 L)	H: 11.25 in. (286 mm) W: 10.38 in. (264 mm) D: 24 in. (610 mm)	43 lb. (20 kg)
Coolmate 3	115 V, 50/60 Hz	5.9 A (50 Hz), 4.7 A (60 Hz)	3,820 W (13,000 Btu/hr.) 4.2 qt./min. (4.0 L/min.)	1,420 W (4,840 Btu/hr.) 1.1 qt./min. (1 L/min.)	3 gal. (11.4 L)	H: 13.25 in. (337 mm) W: 12.25 in. (311 mm) D: 23.25 in. (584 mm)	40 lb. (18 kg)
	230 V, 50/60 Hz	2.5 A (50 Hz), 3.0 A (60 Hz)					
Coolmate 3.5	115 V, 50/60 Hz	5.9 A (50 Hz), 4.7 A (60 Hz)	4,140 W (14,000 Btu/hr.) 5.0 qt./min. (4.7 L/min.)	1,660 W (5,660 Btu/hr.) 1.1 qt./min. (1 L/min.)	3.5 gal. (13.2 L)	H: 11.75 in. (298 mm) W: 15.75 in. (400 mm) D: 26 in. (660 mm)	64 lb. (29 kg)
Coolmate 4	115 V, 50/60 Hz	5.9 A (50 Hz), 4.7 A (60 Hz)	5,500 W (18,000 Btu/hr.) 5.9 qt./min. (5.6 L/min.)	1,780 W (6,070 Btu/hr.) 1.1 qt./min. (1 L/min.)	4 gal. (15 L)	H: 16.25 in. (413 mm) W: 15.25 in. (387 mm) D: 18.75 in. (476 mm)	38 lb. (17 kg)

●●● Accessories

Engine Drive Accessories

Also see Trailers on page 117.

Big Blue Accessories



Cable Holder 043946
For Big Blue 500 Pro/600 Series/800 Series.



Vandalism Lockout Kit 399802 Field
For Big Blue 500 Pro/600 Series. Lockable hinged steel panels cover and protect name plate gauges and ignition switch (padlock included). Also includes engine compartment door lock and key.

Blue Star Accessories



Lifting Eye 195353
For Fusion and Blue Star.



Running Gear 301246
For Fusion and Blue Star. Compact and balanced, lightweight wheelbarrow-style running gear provides easy onsite mobility.

Bobcat and Trailblazer Accessories (Gas/LP)



Multi-Terrain Running Gear 301460
For Bobcat 200 Air Pak. Includes two heavy-duty Never Flat™ 15-inch tires, two 8-inch rubber swivel casters and a heavy-duty handle. Recommended for all surfaces and applications and is easy to move around the jobsite.



Multi-Terrain Running Gear 300913 Inner tubes
300914 Never Flat™ tires
For gas/LP Bobcat and Trailblazer (except Air Pak models). Includes two heavy-duty 15-inch tires, two 8-inch rubber swivel casters and a heavy-duty handle. Recommended for all surfaces and applications and is easy to move around the jobsite.



Off-Road Running Gear 300909 Inner tubes
300910 Never Flat™ tires
For gas/LP Bobcat and Trailblazer (except Air Pak models). Includes four heavy-duty 15-inch tires and a rugged handle to provide maximum maneuverability.



Off-Road Running Gear with Protective Cage and Never Flat™ Tires 300912
For gas/LP Bobcat and Trailblazer (except Air Pak models). Running gear and rugged cage with cable holders protects your investment and is easy to move around the jobsite.



Protective Cage with Cable Holders 300921
For gas/LP Bobcat and Trailblazer (except Air Pak models).

300473 For Trailblazer 302 Air Pak.

Rugged cage with cable holders protects your investment. Works with Running Gear, Gas Cylinder Mounting Assembly or LP Tank Mounting Assembly.



Gas Cylinder Mounting Assembly 300918
For gas Bobcat and Trailblazer (except Air Pak models). Designed for use with Running Gear, Protective Cage, or by itself. Includes base tray with bottle bracket, vertical support rack and safety chain.

Note: Not for use with LP Tank Mounting Assembly. Not recommended for use with Protective Cover.



Hose and LP Tank Mounting Assembly 300917
For LP Bobcat and Trailblazer. Designed for use with Running Gear, Protective Cage, or by itself. Includes bracket and clamp to mount 33- and 43-pound tanks horizontally, and hose with fittings to converter.

Note: Cannot be used with Gas Cylinder Mounting Assembly. Not recommended for use with Protective Cover.



Remote Oil Drain and Filter Kit 300923 Field
For gas Bobcat and Trailblazer (except Air Pak models). Front mount for Kohler engines makes servicing easy when engine drive is mounted in tight spots.

Bobcat and Trailblazer Accessories (Diesel)



All-Purpose Running Gear with Never Flat™ Tires 300477
For diesel Bobcat 250 and Trailblazer 325. Includes two heavy-duty 15-inch tires, two 8-inch rubber swivel casters and a heavy-duty handle. Recommended for

all surfaces and applications and is easy to move around the jobsite.



Protective Cage with Cable Holders 195331
For diesel Bobcat 250 and Trailblazer 325. Rugged cage with cable holders protects your investment. Works with Running Gear, or with trailer.

Note: Not for use with Protective Cover.

Generator Accessories



Twist Lock Adapter Cord 301489
For Fusion. L14-30R to NEMA 6-50R. Adapts engine drive 120/240-volt twist lock plug to common Millermatic and Spectrum 240-volt plug.



Female Receptacle

Full KVA Adapter Cord 300517
For Bobcat, Trailblazer and Big Blue models. NEMA 14-50P to NEMA 6-50R. Adapts engine drive 120/240-volt plug to common Millermatic and Spectrum 240-volt plug.



Full KVA Plug Kit 119172 1-phase, 120/240 V, 50 A plug (NEMA 14-50P). For Bobcat, Trailblazer and Big Blue models.
165963 3-phase, 480 V, 30 A plug (NEMA L16-30P). For Bobcat 3 Phase.
254140 3-phase, 240 V, 50 A plug (NEMA 15-50P). For Big Blue 500 Pro/600 Series/800 Series.

Female Receptacle

Protective Covers



Protective covers (300919) and (195301) shown.

Protective Covers

Heavy-duty, water- and mildew-resistant covers protect and maintain the finish of the welder.

301245 For Fusion and Blue Star.

301475 For gas Bobcat 200 Air Pak **without** Running Gear.

301476 For gas Bobcat 200 Air Pak **with** Running Gear.

301531 For diesel Bobcat 200 Air Pak **without** Running Gear.

301532 For diesel Bobcat 200 Air Pak **with** Running Gear.

300919 For gas Bobcat and Trailblazer (except Air Paks) **without** Protective Cage or Running Gear.

300920 For gas Bobcat and Trailblazer (except Air Paks) **with** Protective Cage or Running Gear.

301099 For diesel Bobcat 250 and Trailblazer 325 **without** Protective Cage or Running Gear.

300379 For Trailblazer 302 Air Pak.

195301 For Big Blue 400 Pro/400 PipePro/450 Duo CST.

301495 For Big Blue 500 Pro/600 Pro with Kubota.

301113 For Big Blue 600 Air Pak/800 Series with Deutz.

Trailers

See literature AY/20.0



HWY-Mid Frame Trailer 301438

For Bobcat, Trailblazer and Big Blue 400 Pro/400 PipePro/450 Duo CST. A 1,424-pound (646 kg) capacity highway trailer with welded steel tubing frame, heavy-duty axle with roller bearing hubs and leaf-spring suspension. Includes jack stand, fenders, lights, and dual hitch with 2-inch (50 mm) ball hitch and 3-inch (76 mm) lunette eye.

HWY-225 Trailer 301338

For Big Blue models. A 2,700-pound (1,225 kg) capacity highway trailer with welded steel tubing frame, heavy-duty axle with roller bearing hubs and leaf-spring suspension. Includes jack stand, fenders, lights, and dual hitch with 2-inch (50 mm) ball hitch and 3-inch (76 mm) lunette eye.

4 West Four-Wheel Steerable Off-Road Trailer 042801

For Big Blue 500 Pro/600 Series/800 Series. A heavy-duty 2,550-pound (1,157 kg) capacity trailer designed for use in mines, quarries and other rough terrain. Has narrow 22-foot (6.7 m) turning radius. Includes 3-inch (76 mm) lunette eye, universal hitch and safety chains.

Note: Trailers are shipped unassembled. **Width at outside of fenders. **Does not include tongue.

Trailer accessories

Fender Kit 301439

For HWY-Mid Frame and HWY-225. Replacement fenders.

Dual Hitch 301441

For HWY-Mid Frame and HWY-225. Combination 2-inch (50 mm) ball hitch and 3-inch (76 mm) lunette eye in one reversible assembly.



Cable Tree 043826

For HWY-Mid Frame and HWY-225. Provides an area to conveniently wrap weld cables and extension cords.



2-In-1 Document/Fire Extinguisher Holder 301236

For HWY-Mid Frame and HWY-225. Stores documents and holds a 5-pound fire extinguisher.

Note: Holder shown mounted on trailer. Fire extinguisher not included.



Model	Gross Axle Weight Rating	Gross Vehicle Weight Rating	Net Payload	Height of Bed	Road Clearance	Track (Center to Center of tires)	Standard Tires (Standard Rating or P-size Rating)	Dimensions	Net Weight
HWY-Mid Frame	1,605 lb. (728 kg)	1,424 lb. (646 kg)	1,424 lb. (646 kg)	19.5 in. (495 mm)	8 in. (203 mm)	46 in. (1,168 mm)	ST175/80D-13 Load Range C	L: 101 in. (2,565 mm) W: 55 in. (1,397 mm)*	181 lb. (82 kg)
HWY-225	3,500 lb. (1,588 kg)	2,999 lb. (1,360 kg)	2,700 lb. (1,225 kg)	19 in. (483 mm)	7.5 in. (191 mm)	50 in. (1,270 mm)	ST175/80R-13 Load Range D	L: 105.5 in. (2,680 mm) W: 56.5 in. (1,435 mm)*	280 lb. (127 kg)
4 West	2,000 lb./axle (907 kg/axle)	3,000 lb. (1,361 kg)	2,550 lb. (1,157 kg)	21.25 in. (540 mm)	8 in. (203 mm)	55.25 in. (1,403 mm)	B78-13	L: 91 in. (2,311 mm)** W: 61.25 in. (1,556 mm)	420 lb. (191 kg)

Load Banks



LBP-350 043329

Designed to provide an adjustable load for troubleshooting or calibrating welding power sources or generators. Standard equipment

includes analog meters for both AC and DC output with jacks for external metering connections. It comes with a 13-foot (4 m) 115-volt power cord and has seven 50-amp load switches, providing a maximum capacity of 350 amps.



Welding Power Load Bank 902804

Designed to load test the output of transformer-type, engine- or motor-driven generator welding power sources. This unit can be used to test AC or DC welder outputs, and to demonstrate welding equipment to customers.

MIG Accessories

Machine and Gun Accessory Kits



MIG kit with Dinse-style connectors for single-wire feeders shown.

Industrial MIG 4/0 Kit (with lugs)

300390 For single-wire feeders.

300957 For dual-wire feeders.

Consists of flowmeter regulator with 10-foot (3 m) gas hose, 10-foot (3 m) 4/0 feeder weld cable with lugs, and 15-foot (4.6 m) work cable with 600-amp C-clamp. Dual kit comes with two flowmeter regulators and gas hoses.

Industrial MIG 4/0 Kit (with Dinse-style connectors)

300405 For single-wire feeders.

300956 For dual-wire feeders.

Same as above except weld and work cables have Dinse-style connector on one end instead of lug.

MIGmatic™ M-Series Gun Consumable Kits

234607 .023 in. (0.6 m) wire

234608 .030 in. (0.8 m) wire

234609 .035 in. (0.9 m) wire

For M-100/M-150 guns. Kits include ten contact tips, one tip adapter, one standard nozzle and a consumable storage box.

Protective Covers



301262

For Millermatic 141/211 and Multimatic 215.



301524

For Multimatic 220 AC/DC.



301521

For Millermatic 255 and Multimatic 255. Features side pocket.



195142

For Millermatic 212 Auto-Set/252/350P/350P Aluminum and Syncrowave 210. Features side pocket.

Plasma Cutter Accessories

Automation Kits



Spectrum 875 Auto-Line automation kit shown.

Automation Kits for Spectrum 875 and 875 Auto-Line 301156 For Spectrum 875.

301157 For Spectrum 875 Auto-Line.

Upgrades hand-held torch packages to add machine torch capabilities. Automation kit for Spectrum 875 Auto-Line (**301157**) includes a remote pendant control for manual on/off. Machine torches are NOT included in kits and must be ordered separately.

Cables and Cable Covers



Flexible Work Cable

234838 20 ft. (6.1 m)

234930 50 ft. (15.2 m)

Work cable with quick connect and heavy-duty clamp.



Cable Covers

239642 20 ft. (6.1 m)

231867 25 ft. (7.6 m)

231868 50 ft. (15.2 m)

Cutting Guides

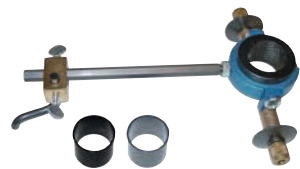

Plasma Circle-Cutting Guides 253055

For XT30/XT40/XT60 torches. Cut straight lines or circles up to 12 inches in diameter.



Suction/Magnetic Pivot Base 195979

Add this to your cutting guide for convenient attachment to all flat surfaces. The extended arm accommodates holes up to 30 inches in diameter.



Plasma Standoff Roller Guide 253054

Helps maintain recommended standoff distance to maximize cutting performance and improve tip life.

Filters



In-Line Air Filter Kit 228926

For Spectrum 375 X-TREME/625 X-TREME/875/875 Auto-Line. Mounts to back of the plasma cutter. Includes male and female 1/4-inch NPT quick-disconnect fittings and hose for easy on/off connection. The replaceable filter element (**228928**) filters to .85 microns for removal of 99.9 percent of water, dirt and oil.



RTI Filter and Bracket 300491

For Spectrum 875/875 Auto-Line. Dryer will remove water, dirt and oil as small as one micron with 99.9 percent efficiency. Can be mounted on plasma cutter or on wall. Install as close as possible to point of air consumption. Replaceable filter element (**212771**).

Plugs and Cords

MVP™ Plugs



219258

For 6-50P power cable (230/240 V, 50 A).



219261

For 5-15P power cable (115/120 V, 15 A).



219259

For 5-20P power cable (115/120 V, 20 A).

For Spectrum 375 X-TREME, Millermatic 211, Multimatic 200/215/220 AC/DC, Thunderbolt 160, Diversion, Syncrowave 210 and Fusion. Allows connection of machine to 115/120-volt or 230/240-volt receptacles without tools — just choose the plug that fits the receptacle.

MVP™ Adapters



Female Receptacle



254328

For connection to 6-50P receptacle (240 V, 50 A).



254330

For connection to 5-15P receptacle (120 V, 15 A).



254331

For connection to 5-20P receptacle (120 V, 20 A).

For Spectrum 625 X-TREME. Allows connection of machine to 120- or 240-volt receptacles without tools — just choose the adapter cord that fits the receptacle.



Female Receptacle

Full KVA Adapter Cord 300517

NEMA 14-50P to NEMA 6-50R. Adapts engine drive 120/240-volt plug to common Millermatic and Spectrum 240-volt plug.

230-Volt Extension Cord 770644

20-foot (6.1 m) NEMA 6-50P to NEMA 6-50R heavy-duty extension cord. 8-gauge cord has lighted ends that show power is on and a molded integrated strain relief.

Protective Case



X-CASE 300184

For Spectrum 375 X-TREME/625 X-TREME.

Torches

See your Miller® distributor for complete information on the following XT plasma torches and their consumables:



Spectrum Plasma Cutter Hand-Held Torches

For Spectrum 375 X-TREME

249949 12 ft. (3.7 m) XT30

For Spectrum 625 X-TREME

260633 12 ft. (3.7 m) XT40

260635 20 ft. (6.1 m) XT40

For Spectrum 875 and 875 Auto-Line

249953 20 ft. (6.1 m) XT60

249954 50 ft. (15.2 m) XT60



Spectrum 875 and 875 Auto-Line Plasma Cutter Machine Torches

249955 25 ft. (7.6 m) long body XT60M

249956 50 ft. (15.2 m) long body XT60M

257464 25 ft. (7.6 m) short body XT60M

263952 50 ft. (15.2 m) short body XT60M



Each consumable kit includes a storage box.

Plasma Torch Consumable Kits

253520 For XT30 torch. Includes five electrodes, five tips, one swirl ring, one retaining cup, one o-ring and silicone grease.

253521 For XT40 torch. Includes five electrodes, five 40-amp tips, three 30-amp tips, one 40-amp drag shield, two 30-amp drag shields, one deflector, one o-ring, one swirl ring, one retaining cup, one 40-amp gouge tip, one gouge shield and silicone grease.

256033 For XT60 torch. Includes three standard electrodes, three standard tips, one drag shield, one deflector, one o-ring, one swirl ring, one retaining cup, one gouge tip, one gouge shield and silicone grease.

127493 Empty consumable storage box.

Polarity Switches/Controls

Polarity Control 042871

This dual-function control is designed for use with dual wire feeders or any application where electrical isolation and/or polarity reversing of weld current is required. Both functions can be used at the same time.



Process Selector Control 042872

For CC, CV or CC/CV welding power source. Provides easy way to change welding process. Also includes features of Polarity Control.

Remote Controls

Also see Remote Controls in TIG Accessories on pages 120 and 121.



PRHC-14 Hand Control 195511
For all solid-state power sources after serial number JK674521. Complete current or voltage control brings 120 volts of GFCI power to work area in a single cord. Housed in a durable and light aluminum case and includes 125-foot (38 m) cord with plugs.

Stick Accessory Kits



No. 2 Stick Cable Sets

195196 15 ft. (4.6 m)
300836 50 ft. (15 m)

Consists of either 15- or 50-foot electrode cable with holder and work cable with clamp. 200 A, 100% duty cycle.



2/O Stick Cable Sets

173851 50 ft. (15 m), 350 A
043952 100/50 ft. (30/15 m), 300 A

Consists of either 50- or 100-foot 2/O electrode cable with holder and 50-foot work cable with clamp. 100% duty cycle.



Weld Cables

195457 2/O cable with electrode holder, 400 A
195458 2/O cable with work clamp, 400 A
301387 1/O cable with electrode holder, 250 A
Consists of a stud/Tweco® adapter and 10-foot (3 m) weld cable with a Tweco male connector and either an electrode holder or work clamp.



2/O Weld Cable Extensions

195456 50 ft. (15 m)
195455 100 ft. (30 m)
Extends weld cables
(**195457**, **195458** and **301387**).

Submerged Arc Accessories

Cables



SubArc Control Cables

260622030 30 ft. (9.1 m)
260622050 50 ft. (15 m)
260622060 60 ft. (18.3 m)
260622080 80 ft. (24.4 m)
260622100 100 ft. (30.5 m)
260622120 120 ft. (36.6 m)
260622200 200 ft. (61.0 m)

Cable between SubArc Interface or Motor Control and power source.



Flux Hopper Extension Cables

260623010 10 ft. (3 m)
260623025 25 ft. (7.6 m)
260623065 65 ft. (19.8 m)

Cable between SubArc Interface or Motor Control and flux hopper.



Motor Extension Cables

254232005 5 ft. (1.5 m)
254232010 10 ft. (3 m)
254232025 25 ft. (7.6 m)
254232065 65 ft. (19.8 m)

Cable between SubArc Interface or Motor Control and drive motor.



Continuum Motor/Control Cables

263368015 15 ft. (4.6 m)
263368025 25 ft. (7.6 m)
263368050 50 ft. (15 m)
263368080 80 ft. (24.4 m)
263368100 100 ft. (30.5 m)

Cable between SubArc Motor Control and SubArc Remote Pendant.



SubArc Parallel Cable

260775015 15 ft. (4.6 m)



SubArc Tandem Cable

260878015 15 ft. (4.6 m)

Torch Accessories

OBT 600 Torch Body Extensions

043967 1 inch (25.4 mm)
043969 2 inch (50.8 mm)
043973 4 inch (101.6 mm)
043975 6 inch (152.4 mm)

OBT 1200 Torch Body Extension 043981

Overall length with extension is 9 inches (228.6 mm). Actual length of extension is 8.5 inches (215.9 mm).

OBT Torch Contact Tips

OBT 600	OBT 1200	Wire Size
192700	192141	1/16 in. (1.6 mm)
192701	199026	5/64 in. (2.0 mm)
192702	192142	3/32 in. (2.4 mm)
192703	200771	7/64 in. (2.8 mm)
192704	192143	1/8 in. (3.2 mm)
192705	192144	5/32 in. (4.0 mm)

1200-Amp Twin-Wire Torch Contact Tips

264595 3/64 in. (1.2 mm)
264596 1/16 in. (1.6 mm)
264597 5/64 in. (2.0 mm)
264588 3/32 in. (2.4 mm)

Wire Drive Assembly Accessories

Drive Rolls

132955 1/16 in. (1.6 mm)
132960 5/64 in. (2.0 mm)
132961 3/32 in. (2.4 mm)
132962 7/64 in. (2.8 mm)
132963 1/8 in. (3.2 mm)
193700 5/32 in. (4.0 mm)



Single-Wire Straightener 199733

For OBT 600 and OBT 1200 single-wire torches. For 1/16–5/32 inch (1.6–4.0 mm) wire.



Twin-Wire Straightener 301160

For 1200-amp twin-wire torch only. Single adjustment.



Manual Single Slide 301137

Provides smooth and accurate movement of the welding heads. Allows for 7.87 inch (200 mm) travel adjustment with load capacity of 220 pounds (100 kg) at 1.64 feet (500 mm). **Not recommended for tandem.**



Wire Reel 108008

Supports 60-pound (27 kg) coil of wire. Requires Spool Support Assembly (**119438**).

TIG Accessories

Kits



A-200 torch with RCCS-14 kit shown.

Contractor Kit

301309 A-150 torch with RFCS-14 HD foot pedal
301311 A-150 torch with RCCS-14 fingertip
301549 A-200 torch with RFCS-14 HD foot pedal
301550 A-200 torch with RCCS-14 fingertip
 For Maxstar 210/280 and Dynasty 210/280. All-in-one TIG/stick welding kit comes with either a Weldcraft™ A-150 OR or A-200 TIG torch, RFCS-14 HD foot control OR RCCS-14 fingertip control, 200-amp stick electrode holder and 300-amp work clamp with 15-foot (4.6 m) cables, flow gauge regulator with 12-foot (3.7 m) gas hose, gas hose coupler, AK2C torch accessory kit, and TIG torch connector.

TIG Contractor Kit 301287

For Multimatic 200.

301337

For Multimatic 215.

Kit comes with Weldcraft™ A-150 TIG torch with Dinse-style connector, either a

Multimatic 215 contractor kit shown.
 RFCS-6M foot control (Multimatic 200 kit) OR RFCS-RJ45 foot control (Multimatic 215 kit), flow gauge regulator with 12-foot (3.7 m) gas hose, and AK2C torch accessory kit.

Multimatic 255 TIG Kit 301518

Kit comes with 25-foot (7.6 m) Weldcraft™ A-150 TIG torch with Dinse-style connector, RFCS-14 HD foot control,

10-pin to 14-pin adapter cord, flow gauge regulator with 5-foot (1.5 m) gas hose, and AK1C torch accessory kit.



W-280 torch kit shown.

Weldcraft™ Water-Cooled Torch Kits

300185 250 A, W-250 (WP-20)
300990 280 A, W-280 (WP-280)
301268 375 A, W-375
300186 400 A, W-400 (WP-18SC)
 For Maxstar (except 161 models), Dynasty, and Syncrowave 300. Kit comes with 25-foot (7.6 m) TIG torch with Dinse-style connector (thread-lock on 400-amp kit), torch cable cover, work clamp with 15-foot (4.6 m) cable [12-foot (3.7 m) cable on 400-amp kit], flowmeter regulator with gas hose, and gas lens accessory kit.

Protective Case/Covers



X-CASE 301429
 For Maxstar 161 models.



Protective covers (300579) and (301382) shown.

300579 For Diversion.

301381 For Maxstar 210.

301382 For Maxstar 280 and Dynasty 210/280.

195142 For Syncrowave 210.

Remote Controls



14-Pin to 6-Pin Adapter Cord 300507

For Maxstar 161 STL/STH and Multimatic 200. 12-inch (305 mm) cord adapts Miller®

14-pin foot control or fingertip control to a 6-pin plug.



10-Pin to 14-Pin Adapter Cord 301545

For Multimatic 255.

Allows standard 14-pin

TIG remote controls to be used with the Multimatic 255.



RCC-6M (6-pin plug)

301118 13.25 ft. (4 m) cord with plug
 For Maxstar 161 STL/STH and Multimatic 200.

RCC-14 (14-pin plug)

151086 26.5 ft. (8 m) cord with plug
 East/west rotary-motion fingertip current/contacter control attaches to TIG torch using two hook-and-loop fasteners. Great for production or contractors that need quick ramp-up.



RCCS-6M (6-pin plug)

195184 13.25 ft. (4 m) cord with plug
195503 26.5 ft. (8 m) cord with plug
 For Maxstar 161 STL/STH and Multimatic 200.

RCCS-RJ45

301146 13.25 ft. (4 m) cord with plug
 For Diversion and Multimatic 215.

RCCS-14 (14-pin plug)

043688 26.5 ft. (8 m) cord with plug
 North/south rotary-motion fingertip current/contacter control attaches to TIG torch using two hook-and-loop fasteners. Great for applications that require a finer amperage control.



RFCS-RJ45 300432

For Diversion and Multimatic 215. Foot pedal current/contacter control. Includes 14-foot (4.3 m) cord with plug.



RFCS-6M HD (6-pin plug)

195183 13.25 ft. (4 m) cord with plug
195504 20 ft. (6 m) cord with plug
 For Maxstar 161 STL/STH and Multimatic 200.

RFCS-14 HD (14-pin plug)

194744 20 ft. (6 m) cord with plug
 Heavy-duty foot pedal current/contacter control provides increased stability and durability from larger base and heavier cord. Reconfigurable cord can exit front, back or either side of the pedal for flexibility.



RHC-14 (14-pin plug)

242211020 20 ft. (6 m) cord with plug
242211100 100 ft. (30.5 m) cord with plug
 Miniature hand current/contacter control. Dimensions: 4 x 4 x 3.25 inches (102 x 102 x 82 mm).



RMLS-14 (14-pin plug) 129337

Momentary- and maintained-contact rocker switch for contactor control. Push forward for maintained contact and backward for momentary contact. Includes 26.5-foot (8 m) cord with plug.



RMS-6M (6-pin plug) 195269

For Maxstar 161 STL/STH.

RMS-14 (14-pin plug) 187208

Momentary-contact switch for contactor control. Rubber-covered pushbutton dome switch ideal for repetitive on-off applications. Includes 26.5-foot (8 m) cord with plug.



RPBS-14 (14-pin plug) 300666

Attaches to the TIG torch to remotely start and stop the TIG welding process. Includes 25-foot (7.6 m) cord with plug.

Wireless Remote Foot and Hand Controls

See literature AY/6.5 (Foot) and AY/6.6 (Hand)

Increases productivity, saves money, improves safety and easy to use.



Wireless 14-pin receiver
(included with both systems)

Wireless hand control

Foot control

Foot control is designed specifically for TIG welding in manufacturing, fabrication and plant applications, allowing operator to adjust amperage at point of use without the limitations of remote cord.

Auto on feature extends the battery life up to 250 hours of welding without turning the pedal on and off.

Easy-Glide Wear Pads™ glide across concrete, making it easy to reposition the pedal for comfort and speed.

**Some applications are not suitable for wireless communication. Keep in mind that the rated range is subjective, and depends on factors such as obstructions, frequency interference, transmission technology, and weather. The figures listed assume ideal conditions are present.*

Improves productivity and maneuverability by eliminating cord tangles. Reduces clean up time and work area cord clutter.

Improves safety by eliminating control cord and reducing potential trip hazard.

Improves reliability by eliminating control cord failure.

Multiple frequency sharing allows up to 20 systems to operate in a 90-foot (27.4 m) radius with accuracy and precision — and without delay, system interference, or crosstalk.

Easy-to-install receiver plugs directly into the 14-pin receptacle of Miller® machines.

Easily programmable. Control can be quickly and easily paired with any other Miller 14-pin wireless receiver. (Control is preprogrammed when purchased with the receiver.)

Hand control

Hand control is designed for stick, TIG, MIG and flux-cored welding, allowing operator to adjust parameters for different joint configurations, electrodes and wire types/sizes at the point of use instead of walking back to the machine.

Allows parameter adjustments up to 300 feet away from welder without returning to machine.

Improves weld quality. Operators can adjust their machines to optimize the parameters for different joint configurations, electrodes, and wire types and sizes.

Smart Touch™ buttons allow quick and accurate machine parameter adjustments.

Digital meter display allows presetting percentage of machine output before welding, and viewing amperage and voltage while welding.

Industrial ●

Processes

▪ TIG (GTAW) ▪ Pulsed TIG (GTAW-P)

The following processes are with hand control only

▪ Stick (SMAW) ▪ MIG (GMAW)*
▪ Flux-cored (FCAW)

**Only with voltage-sensing feeder.*

Comes complete with

- Wireless foot control (300429) OR hand control (300430) transmitter
- Wireless 14-pin receiver (300722)
- Battery box (249297)
- Three AA batteries
- Four Easy-Glide Wear Pads™ (for foot control only) (sold individually, 248274)
- Belt clip (for hand control only) (249233)

Suggested power sources



Look throughout this catalog for the icon above signifying compatibility with a wireless remote. For a complete power source compatibility list visit, MillerWelds.com/wireless

Model/Stock Number	Component	Power Supply	Battery Life	Rated Range*	Temperature	Radio Frequency	RF Power	Antenna	Dimensions	Weight
Wireless Foot Control System (300429)	Foot control (transmitter)	Three AA batteries	250 hours	90 ft. (27.4 m)	-13° to +158°F (-25° to +70°C)	2.4 Ghz (ISM band)	<3 mW	Internal	H: 6 in. (152 mm)	3 lb. (1.4 kg)
Wireless Hand Control System (300430)	Hand control (transmitter)	Three AA batteries	250 hours	300 ft. (91 m)					W: 5.75 in. (146 mm)	w/batteries
									H: 5 in. (127 mm)	0.6 lb. (0.27 kg)
									W: 2.75 in. (70 mm)	w/batteries
									D: 1.375 in. (35 mm)	

TIG Accessories (continued)

Torch and Weld Cable Connectors

Air-Cooled TIG (GTAW) Torch Connectors



273483^{1,2}
For Multimatic 200/215/220 and Maxstar 161.
25 mm (small) Dinse-style gas thru for one-piece air-cooled torches.



194723 A-200 (WP26)
194722² All others
For Syncrowave 210.
50 mm Dinse-style gas thru for one-piece air-cooled torches.



195379 A-200 (WP26)
195378² All others
For Multimatic 255, CST, Maxstar 210/280/400, Dynasty 210/280/400 and Syncrowave 300.
50 mm Dinse-style for one-piece air-cooled torches.

Water-Cooled TIG (GTAW) Torch Connectors



50 mm Dinse-Style Flow Thru 195380
For Syncrowave 210.
Used with all Weldcraft™ water-cooled torches.



50 mm Dinse-Style with Water Return Line 195377
For Maxstar 210/280/400, Dynasty 210/280/400 and Syncrowave 300.
Used with all Weldcraft™ water-cooled torches.



50 mm Thread-Lock-Style 225028
For Maxstar/Dynasty 800.
Used with all Weldcraft™ water-cooled torches.



Thread-Lock-Style Weld Cable Connectors 225029
For Maxstar/Dynasty 800.
Contains two male connectors that accept #1/0 to #4/0 AWG size cable.

¹Except A-200 (WP26) torches. ²A-80 (WP24) torches require 24-5 adapter.

Wire Feeder Accessories

Extension Cables (14-Pin)

8-Conductor Cables

242208025 25 ft. (7.6 m)

242208050 50 ft. (15 m)

242208080 80 ft. (24.4 m)

For SuitCase 12RC feeder, 20 Series feeders, and 70 Series (except MPa Plus) feeders. For 14-pin remote controls and 24 VAC wire feeders. 14-pin plug to a 14-pin socket. (Not for 115-volt XR feeders.)

11-Conductor Cables

247831025 25 ft. (7.6 m)

247831050 50 ft. (15 m)

247831080 80 ft. (24.4 m)

For XR-AlumaFeed and MPa Plus feeders. Eleven conductors to support contactor control and remote voltage control on all Miller® electronic constant-voltage (CV) 14-pin power sources. Additional functions supported when using the Invision MPa or XMT MPa power sources include synergic pulsed MIG, remote process select and side select capabilities.

14-Conductor Cables

242205025 25 ft. (7.6 m)

242205050 50 ft. (15 m)

For HDC and WC-115 weld controls. Fully-loaded 14-pin extension cables for remote controls, and 24-volt and 115-volt feeders.

Power Supply Adapter



PSA-2 Control 141604

Required when using SuitCase 12RC, 20 Series, and 70 Series feeders with power sources having only 115-volt power available. Control is equipped with a 14-pin receptacle and a 10-foot (3 m) interconnecting cord with Hubbell connections

for older-style power sources. Can also be used with competitive power sources requiring a contact closure for contactor control.

PSA-2 Extension Cord 047813

25-foot (7.6 m) cord extends 10-foot (3 m) cord supplied with PSA-2 control (4-pin to 4-pin connection).

Spool Adapter

047141

For use with 14-pound (6.4 kg) spool of Hobart or Lincoln self-shielding wire.

Spool Gun Controls and Kits

For more information see literature M/1.5, M/1.73 and M/1.76.



SGA 100 043856

Required to connect Spoolmate 3035 spool gun to any Millermatic 141/211. Also allows connection to virtually

any similar MIG welder – Miller or other brands. Includes 10-foot (3 m) 115-volt power cable with plug, 6-foot (1.8 m) interconnecting cable, and 5-foot (1.5 m) gas hose.



SGA 100C 043857

SGA with contactor required to connect Spoolmate 3035 spool gun to CV engine drives like the Miller Bobcat. Includes 10-foot (3 m) 115-volt power cable with plug, 6-foot (1.8 m)

interconnecting cable, and 5-foot (1.5 m) gas hose.



WC-115A Weld Control

137 546 Without contactor

137546011 With contactor

Operates on 115-volt power and designed primarily for constant-current DC power sources. Can also be used with

constant-voltage (CV) power sources or DC engine drives supplying 115 volts. Used with a constant-current (CC) source the control circuit functions in a voltage-sensing mode, and with a CV source it functions as a constant-speed circuit. Includes wire run-in and drive motor acceleration controls which ensure optimum arc starting performance.



WC-24 Weld Control 137549

For Spoolmate 200, Spoolmatic and Spoolmatic Pro.

Easily mounts on power source. Designed for use with Miller® constant-voltage (CV) power sources with 14-pin receptacles and supplying 24 VAC.

Spool Gun Extension Hose and Cable Kits

132228 25 ft. (7.6 m)

132229 50 ft. (15 m)

For Spoolmate 200, Spoolmatic and Spoolmatic Pro.

Extends leads, etc. between spool gun and power source.

Turntable Assembly

146236

Allows feeder to rotate as operator changes work position. Reduces strain and bending of gun cable.

Wire Straightener



For 20 Series and 70 Series.

141580 For .035-.045 inch (0.9-1.1 mm) wire.

141581 For 1/16-1/8 inch (1.6-3.2 mm) wire.



Engineered for Simplicity. Built for Durability.

Design the perfect MIG guns for all your welds!

Improve welding productivity by choosing the neck length and angle, handle shape and trigger style that allows welders to comfortably and efficiently reach all your welds.

Plus, longer gun life and shared parts and consumables will help to simplify inventory and minimize costs across your shop.

For additional information, please contact your local welding distributor.

To request a catalog, please call or complete our online request form.



Miller recommends



It's the tie that binds



Finding the right filler metal solution for your welding needs is critical in an industry that is about getting the job done right. Filler metals are more than just a component of welding — they are **the tie that binds science and people**. The right solutions. Solutions to make our world more secure. More dynamic. More of what you need.

Every day, every project, every weld is another opportunity for Hobart to earn and secure your trust by helping you find the right filler metal solution.

That kind of help and finding your welding solutions is our passion.

Visit HobartBrothers.com for more information.

















SCIENCE + PEOPLE

Find Your Solution. Today.

Index **New!** or **Improved!** products appear in blue type.

A AlumaFeed Welding System 11	D Dynasty 400 56	M MDX Series MIG Guns. 24	T 20 Series Bench Feeders 20
ArcReach SuitCase Feeders . . 18/46	Dynasty 800 56	MIGmatic M-Series MIG Guns. . . 23	Thunderbolt 160 48
ArcReach Smart Feeder 18/46	F FILTAIR 130 99	Millermatic 141 7	Thunderbolt 210 48
ArcReach Stick/TIG Remotes . . . 46	FILTAIR 4000-12000 102	Millermatic 211 7	Tregaskiss Guns and Peripherals. . 34
ArcStation 111	FILTAIR 4000-12000 Accessories 103	Millermatic 212 Auto-Set 8	Fixed Automatic Guns 34
AugmentedArc System 113	FILTAIR Capture 5. 100	Millermatic 252 8	Robotic Guns. 34
Auto-Continuum Systems 16	FILTAIR MWX Series 100	Millermatic 255 9	TOUGH GUN TT3 Reamers 35
B Bernard MIG Guns 25	FILTAIR SWX Series. 101	Millermatic 350P 10	Welding Consumables. 35
BTB MIG Guns. 25	Fusion 160. 71	Millermatic 350P Aluminum 10	Trailblazer Series 76
Dura-Flux Guns 26	G Gas Equipment. 92	Multimatic 200. 37	Trailblazer 302 Air Pak 78
Fume Extraction Guns 26	Gas Mixers 98	Multimatic 215. 37	Trailers 117
Welding Consumables. 25/26	Heavy-Duty Outfits 96	Multimatic 220 AC/DC. 38	W Weldcraft Series TIG Torches. . . . 58
Big Blue 400 PipePro 79	Medium-Duty Outfits 97	Multimatic 255. 39	Air-Cooled Torches. 59
Big Blue 400 Pro 78	Regulators. 92	P PerformArc Robotic	Automation Torches. 65
Big Blue 450 Duo CST 79	Torches 95	Welding Systems 30	Specialty Torches. 64
Big Blue 500 Pro 80	I Insight ArcAgent 68/69	PipeWorx 400 Welding System . . . 47	Torch Accessories 66
Big Blue 600 Series 80	Insight Centerpoint 69	ProHeat Induction Heating 86	Tungsten 65
Big Blue 800 Series 81	Insight Core 68	S 70 Series Bench Feeders 20	Water-Cooled Torches 62
Blue Star 185. 71	Intellx Feeders and Swingarc . . . 13	70 Series Remote Configurations . 22	Welding Safety and Health 99
Bobcat 200 Air Pak 73	Invision MPa Plus System. 14	70 Series Swingarc. 22	Apparel/Jackets 109
Bobcat Series. 74	J Jetline Fixed Automation. 32	Spectrum Series 90	Gloves 110
C Continuum Systems 15	L LiveArc System 113	Spoolmate Spool Guns. 27	Helmets 106
Coolmate Coolant Systems. 115	M Maxstar 161 S 48	Spoolmatic Spool Guns 28	Helmet Accessories 106/107/108
CST 280 50	Maxstar 161 STL/STH 52	SubArc Digital Series 82	Respiratory 104
CST 280 Racks. 50	Maxstar 210 STR 49	SubArc Components. 83/84	Safety Glasses. 108
D Deltaweld Systems 12	Maxstar 210 Series 54	SubArc Portable Welding System . 85	Weld-Mask 108
Dimension 650/650 ArcReach . . 41	Maxstar 280 Multiprocess 40	SubArc 3-Wheel Tractor 85	Wireless Remote Controls. 121
Diversion 180 52	Maxstar 280 Series 54	SuitCase 12RC Feeder 18	X XMT 350 FieldPro Systems 44
Dynasty 210 Series. 54	Maxstar 400 56	Syncrowave 210 53	XMT 450 CC/CV ArcReach 45
Dynasty 280 DX Multiprocess. . . 40	Maxstar 800 56	Syncrowave 300 57	XMT Racks 45
Dynasty 280 Series. 54			XMT Series 42
			XR Push-Pull Guns 21/29

Contents

INTRO	New from Blue 3 Benefits of Blue 4
	MIG (GMAW) 6
	Wire Feeders 17
	MIG Guns 23
	Automation 30
	Multiprocess 36
	Stick (SMAW) 48
	TIG (GTAW) 51
	Welding Intelligence™ 67
	Engine-Driven 70
	Submerged Arc 82
	Induction Heating 86
	Plasma Cutters 89
	Gas Equipment 92
	Welding Safety and Health 99
	Workstations 111
	Training Solutions 112
	Accessories 114

WE BUILD™ connections

Get connected

► eNewsletters

Get informative email newsletters written for do-it-yourselfers, professionals, instructors and safety specialists.

► Protect Your Investment

Register your product as a precaution against theft or loss.

► Owners Club

Join for exclusive product previews, welding tips, project ideas and more.

Stay connected

► Video Library

Get the how-to tips and guidance you need to tackle even the most challenging welding and cutting applications.

► Project Gallery

Find inspiration and share welding projects for home or work.

► Discussion Forums

Connect with other welders to harness the collective intelligence of the welding community.

MillerWelds.com

Your trusted destination for welding resources, helpful support and high-performance products for all of your projects.

Together, we build connections.



Distributed By: